

## **Zoom-Zoom**

**All children instinctively know it.**

**A few adults still remember it.**

**One unique car company refuses to outgrow it.**

**In grown-up language, it means the exhilaration and**

**liberation that come from experiencing sheer motion.**

**But as usual, children put it much better and simply call it "Go Zoom-Zoom."**

**We practice it every day.**

**It's why we build the kind of cars we do.**

**Zoom-Zoom.**

**Can we re-awaken it in you today?**

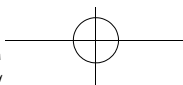

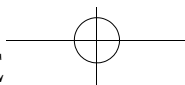
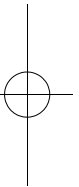
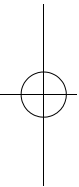
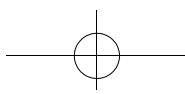

## A Word to Mazda Owners

---

Thank you for choosing a Mazda. We at Mazda design and build vehicles with complete customer satisfaction in mind.

To help ensure enjoyable and trouble-free operation of your Mazda, read this manual carefully and follow its recommendations.

An Authorized Mazda Dealer knows your vehicle best. So when maintenance or service is necessary, that's the place to go.

Our nationwide network of Mazda professionals is dedicated to providing you with the best possible service.

We assure you that all of us at Mazda have an ongoing interest in your motoring pleasure and in your full satisfaction with your Mazda product.

**Mazda Motor Corporation**  
HIROSHIMA, JAPAN

### **Important Notes About This Manual**

Keep this manual in the glove box as a handy reference for the safe and enjoyable use of your Mazda. Should you resell the vehicle, leave this manual with it for the next owner.

All specifications and descriptions are accurate at the time of printing. Because improvement is a constant goal at Mazda, we reserve the right to make changes in specifications at any time without notice and without obligation.

### **Event Data Recorder**

This vehicle is equipped with an event data recorder. In the event of a crash, this device records data related to vehicle dynamics and safety systems for a short period of time. These data can help provide a better understanding of the circumstances in which crashes and injuries occur and lead to the designing of safer vehicles.

### **Air Conditioning and the Environment**

Your Mazda's genuine air conditioner is filled with HFC134a (R134a), a refrigerant that has been found not to damage the earth's ozone layer. If the air conditioner does not operate properly, consult an Authorized Mazda Dealer.

### **Perchlorate**

Certain components of this vehicle such as [air bag modules, seat belt pretensioners, lithium batteries, ...] may contain Perchlorate Material- Special handling may apply for service or vehicle end of life disposal. See [www.dtsc.ca.gov/hazardouswaste/perchlorate](http://www.dtsc.ca.gov/hazardouswaste/perchlorate).

**Please be aware that this manual applies to all models, equipment and options. As a result, you may find some explanations for equipment not installed on your vehicle.**

©2007 Mazda Motor Corporation  
Printed in Japan Aug. 2007(Print3)

## How to Use This Manual

---

We want to help you get the most driving pleasure from your vehicle. Your owner's manual, when read from cover to cover, can do that in many ways.

Illustrations complement the words of the manual to best explain how to enjoy your Mazda. By reading your manual, you can find out about the features, important safety information, and driving under various road conditions.

The symbol below in this manual means "Do not do this" or "Do not let this happen".

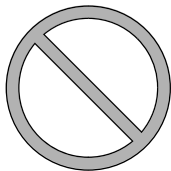

**Index:** A good place to start is the Index, an alphabetical listing of all information in your manual.

You'll find several WARNINGS, CAUTIONS, and NOTES in the manual.

### **WARNING**

*A WARNING indicates a situation in which serious injury or death could result if the warning is ignored.*

### **CAUTION**

*A CAUTION indicates a situation in which bodily injury or damage to your vehicle, or both, could result if the caution is ignored.*

### **NOTE**

*A NOTE provides information and sometimes suggests how to make better use of your vehicle.*

The symbol below, located on some parts of the vehicle, indicates that this manual contains information related to the part. Please refer to the manual for a detailed explanation.



## Table of Contents

<b>Your Vehicle at a Glance</b> Interior, exterior views and part identification of your Mazda.	<b>1</b>
<b>Essential Safety Equipment</b> Use of safety equipment, including seats, seat belt system, child-restraint systems and SRS air bags.	<b>2</b>
<b>Knowing Your Mazda</b> Explanation of basic operations and controls; opening/closing and adjustment of various parts.	<b>3</b>
<b>Before Driving Your Mazda</b> Important information about driving your Mazda.	<b>4</b>
<b>Driving Your Mazda</b> Explanation of instruments and controls.	<b>5</b>
<b>Interior Comfort</b> Use of various features for drive comfort, including air-conditioning and audio system.	<b>6</b>
<b>In Case of an Emergency</b> Helpful information on what to do in an emergency.	<b>7</b>
<b>Maintenance and Care</b> How to keep your Mazda in top condition.	<b>8</b>
<b>Customer Information and Reporting Safety Defects</b> Important consumer information including warranties and add-on equipment.	<b>9</b>
<b>Specifications</b> Technical information about your Mazda.	<b>10</b>
<b>Index</b>	<b>11</b>

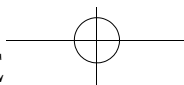
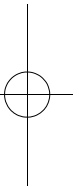
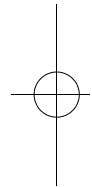
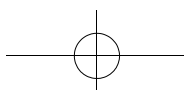

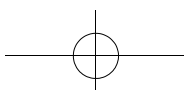

# 1

## Your Vehicle at a Glance

Interior, exterior views and part identification of your Mazda.

<b>Interior Overview .....</b>	<b>1-2</b>
Interior Equipment (View A) .....	1-2
Interior Equipment (View B) .....	1-3
Interior Equipment (View C) .....	1-4
<b>Exterior Overview .....</b>	<b>1-5</b>
Front .....	1-5
Rear .....	1-6

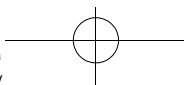

Your Vehicle at a Glance

## Interior Overview

### Interior Equipment (View A)

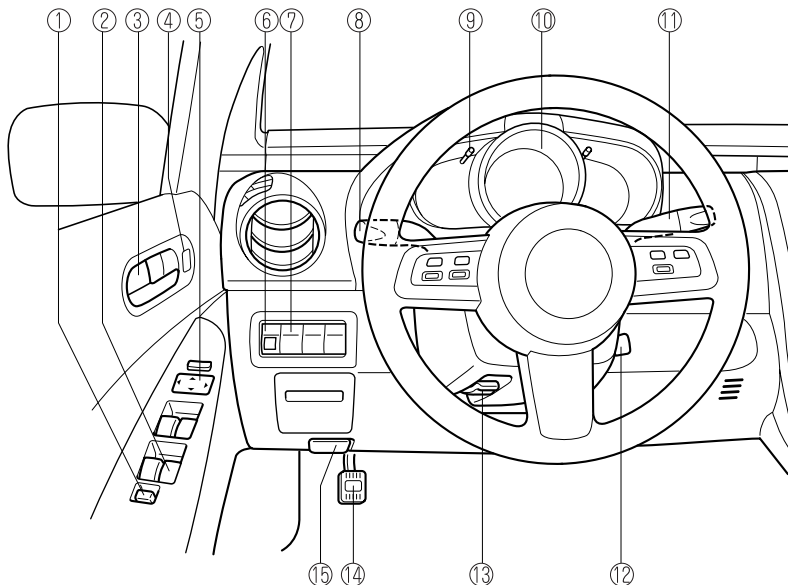

① Power window lock switch .....	page 3-35
② Power window switches .....	page 3-31
③ Door-lock knob .....	page 3-25
④ Power door lock switch .....	page 3-26
⑤ Outside mirror switch .....	page 3-54
⑥ Headlight leveling switch .....	page 5-55
⑦ TCS-OFF switch .....	page 5-22
⑧ Lighting control/Turn signals .....	page 5-53
⑨ Dashboard illumination knob .....	page 5-36
⑩ Instrument cluster .....	page 5-33
⑪ Wiper and washer lever .....	page 5-57
⑫ Ignition switch .....	page 5-2
⑬ Tilt wheel release lever .....	page 3-54
⑭ Parking brake .....	page 5-5
⑮ Hood release handle .....	page 3-39

**1-2** The equipment and installation position varies by vehicle



Your Vehicle at a Glance  
**Interior Overview**

**Interior Equipment (View B)**

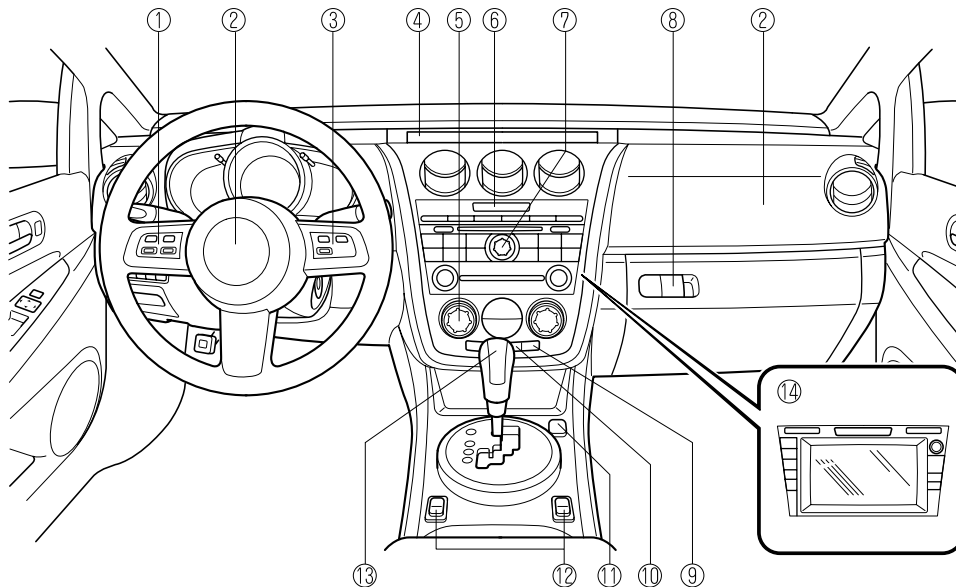

- ① Audio control switch ..... page 6-42
- ② Air bags ..... page 2-47
- ③ Cruise control switches ..... page 5-19
- ④ Information display ..... page 6-49
- ⑤ Climate control system ..... page 6-2
- ⑥ Hazard warning flasher switch ..... page 5-60
- ⑦ Audio system ..... page 6-15
- ⑧ Glove box ..... page 6-53
- ⑨ AMB switch ..... page 6-50
- ⑩ Rear window defroster switch ..... page 5-59
- ⑪ Accessory socket ..... page 6-54
- ⑫ Seat warmer switches ..... page 2-4
- ⑬ AT shift lever (Sport AT) ..... page 5-10
- ⑭ Navigation system (if equipped) ..... Refer to the separate manual

The equipment and installation position varies by vehicle **1-3**

Your Vehicle at a Glance

## Interior Overview

### Interior Equipment (View C)

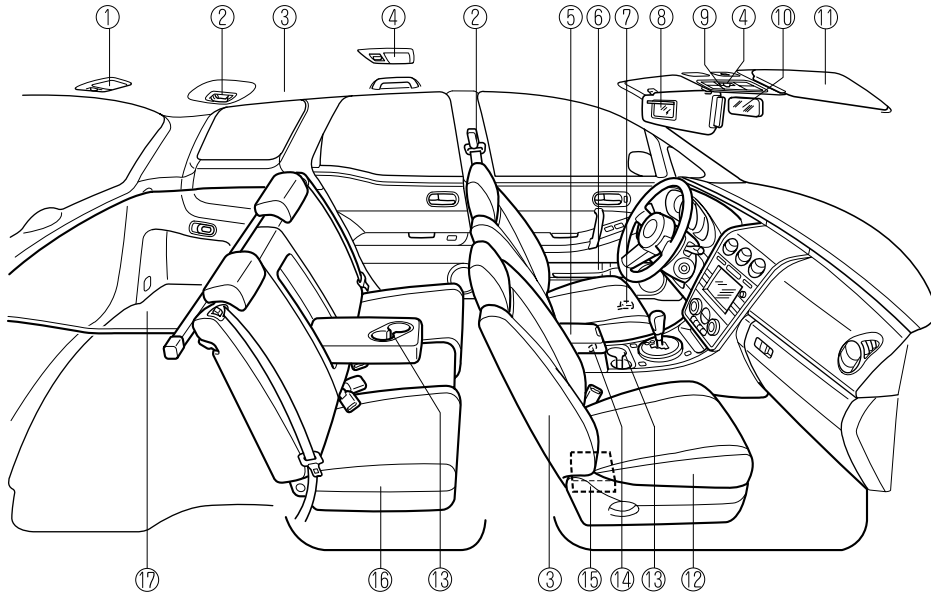

① Luggage compartment light .....	page 6-48
② Seat belt .....	page 2-13
③ Air bags .....	page 2-47
④ Overhead light .....	page 6-47
⑤ Center console .....	page 6-53
⑥ Bottle holder .....	page 6-52
⑦ Remote fuel-filler lid release .....	page 3-38
⑧ Vanity mirror .....	page 6-46
⑨ Moonroof switch .....	page 3-41
⑩ Rearview mirror .....	page 3-55
⑪ Sunvisor .....	page 6-46
⑫ Front seats .....	page 2-2
⑬ Cup holder .....	page 6-51
⑭ Accessory socket .....	page 6-54
⑮ Navigation system (if equipped) .....	Refer to the separate manual
⑯ Rear seat .....	page 2-9
⑰ Luggage compartment cover .....	page 3-29

**1-4** The equipment and installation position varies by vehicle

Your Vehicle at a Glance  
**Exterior Overview**

**Front**

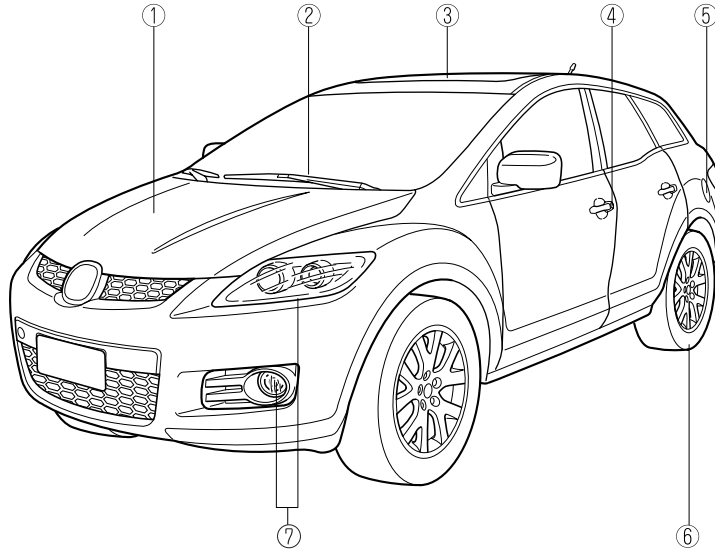

- ① Hood ..... page 3-39
- ② Windshield wiper blades ..... page 8-28
- ③ Moonroof ..... page 3-40
- ④ Doors and keys ..... page 3-25
- ⑤ Fuel-filler lid ..... page 3-38
- ⑥ Tires ..... page 8-34
- ⑦ Light bulbs ..... page 8-39

The equipment and installation position varies by vehicle **1-5**

Your Vehicle at a Glance

## Exterior Overview

### Rear

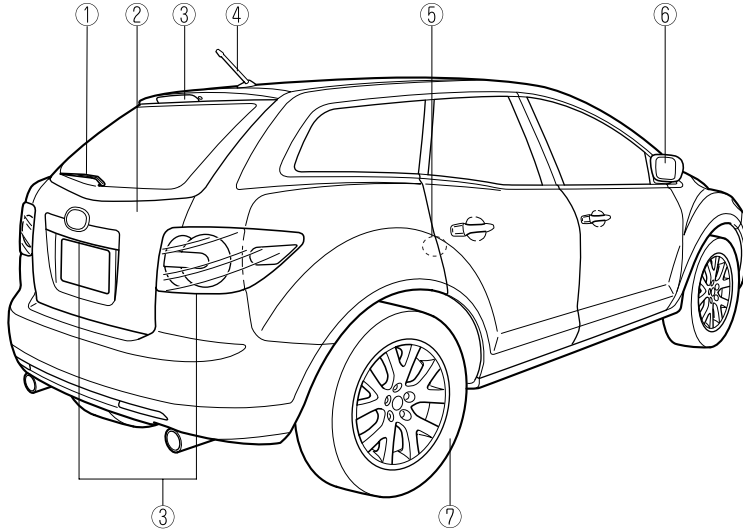

① Rear wiper blade .....	page 8-30
② Liftgate .....	page 3-28
③ Light bulbs .....	page 8-39
④ Antenna .....	page 6-15
⑤ Child safety locks .....	page 3-27
⑥ Outside mirror .....	page 3-54
⑦ Tires .....	page 8-34

**1-6** The equipment and installation position varies by vehicle

# 2

## Essential Safety Equipment

Use of safety equipment, including seats, seat belt system, child-restraint systems and SRS air bags.

<b>Seats .....</b>	<b>2-2</b>
Front Seats (Manually Operated Seats) .....	2-2
Front Seats (Electrically Operated Seats) .....	2-5
Rear Seat .....	2-9
<b>Seat Belt Systems .....</b>	<b>2-13</b>
Seat Belt Precautions .....	2-13
Seat Belt (Except Center-Rear Position) .....	2-17
Front Seat Belt Pretensioner and Load Limiting Systems .....	2-19
Center-Rear Position Seat Belt .....	2-22
Seat Belt Extender .....	2-24
Seat Belt Warning Light/Beep .....	2-26
<b>Child Restraint .....</b>	<b>2-28</b>
Child Restraint Precautions .....	2-28
Installing Child-Restraint Systems .....	2-32
LATCH Child-Restraint Systems .....	2-41
<b>SRS Air Bags .....</b>	<b>2-47</b>
Supplemental Restraint System (SRS) Precautions .....	2-47
Supplemental Restraint System Components .....	2-52
How the SRS Air Bags Work .....	2-53
SRS Air Bag Deployment Criteria .....	2-57
Limitations to SRS Air Bag .....	2-58
Driver and Front Passenger Occupant Classification System .....	2-60
Monitoring and Maintenance .....	2-65

Essential Safety Equipment

## Seats

### Front Seats (Manually Operated Seats)

#### **⚠ WARNING**

**Do not modify or replace the front seats:**

*Modifying or replacing the front seats such as replacing the upholstery or loosening any bolts is dangerous. The front seats contain air bag components essential to the supplemental restraint system. Such modifications could damage the supplemental restraint system and result in serious injury. Consult an Authorized Mazda Dealer if there is any need to remove or reinstall the front seats.*

**Do not drive with damaged front seats:**

*Driving with damaged front seats is dangerous. A collision, even one not strong enough to inflate the air bags, could damage the front seats which contain essential air bag components. If there was a subsequent collision, an air bag may not deploy which could lead to injuries. Always have an Authorized Mazda Dealer inspect the front seats, front seat belt pretensioners and air bags after a collision.*

**Make sure the adjustable components of a seat are locked in place:**

*Adjustable seats and seatbacks that are not securely locked are dangerous. In a sudden stop or collision, the seat or seatback could move, causing injury. Make sure the adjustable components of the seat are locked in place by attempting to slide the seat forward and backward and rocking the seatback.*

#### ▼ Seat Slide

#### **⚠ WARNING**

**Adjust the driver seat only when the vehicle is stopped:**

*Adjusting the driver's seat while the vehicle is moving is dangerous. The driver could lose control of the vehicle and have an accident.*

To move a seat forward or backward, raise the lever and slide the seat to the desired position and release the lever.

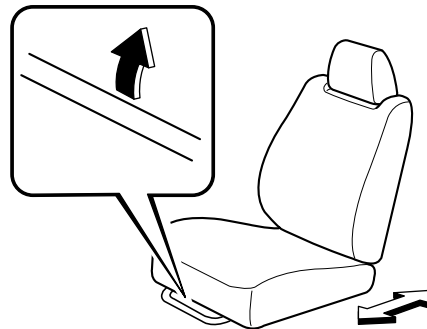

Make sure the lever returns to its original position and the seat is locked in place by attempting to push it forward and backward.

Essential Safety Equipment  
**Seats**

▼ **Seat Recline**

**! WARNING**

**Do not drive with the seats reclined:**  
*Sitting in a reclined position while the vehicle is moving is dangerous because you don't get the full protection from seat belts. During sudden braking or a collision, you can slide under the lap belt and suffer serious internal injuries. For maximum protection, sit well back and upright.*

**Always sit in a passenger seat properly with the seatback upright and feet on the floor:**

*If your vehicle is equipped with front passenger seat weight sensors, sitting in the front passenger seat improperly out of position or with the seatback reclined too far while the vehicle is moving is dangerous as it can take off weight from the seat bottom and affect the weight determination of the front passenger sensing system. As a result the front passenger will not have the supplementary protection of the air bag and seat belt pretensioner, which could cause result in serious injury. Always sit upright against your seatback, with your feet on the floor.*

**Do not drive with the seatback unlocked:**

*The seatback plays an important role in your protection in a vehicle. Leaving the seatback unlocked is dangerous as it can allow passengers to be ejected or thrown around and baggage to strike occupants in a sudden stop or collision, resulting in severe injury. After adjusting the seatback at any time, even when there are no other passengers, rock the seatback to make sure it is locked in place.*

To change the seatback angle, lean forward slightly while raising the lever. Then lean back to the desired position and release the lever.

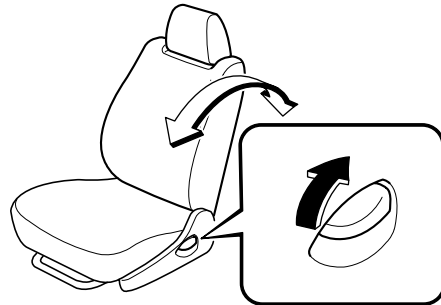

Make sure the lever returns to its original position and the seatback is locked in place by attempting to push it forward and backward.

Essential Safety Equipment

## Seats

### **CAUTION**

*When returning a rear-reclined seatback to its upright position, make sure you hold onto the seatback with your other hand while operating the lever. If the seatback is not supported, it will flip forward suddenly and could cause injury.*

### ▼ Height Adjustment (Driver's Seat)

By moving the seat lever up or down, the seat bottom height can be adjusted.

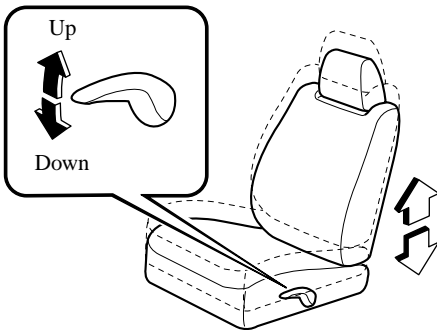

### ▼ Head Restraint

### **WARNING**

***Always drive with the head restraints installed when seats are being used and make sure they are properly adjusted:***

*Driving with the head restraints adjusted too low or removed is dangerous. With no support behind your head, your neck could be seriously injured in a collision.*

### **Height adjustment**

To raise a head restraint, pull it up to the desired position.

To lower the head restraint, press the stop-catch release, then push the head restraint down.

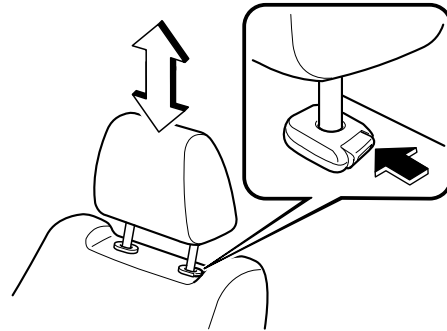

Adjust the head restraint so that the top is even with the top of the passenger's ears, never the passenger's neck to prevent injury.

### ▼ Seat Warmer\*

The front seats are electrically heated. The ignition switch must be in the ON position.

Press the switch to turn the seat warmer on or off. When the switch is in the ON position, the indicator light will come on.

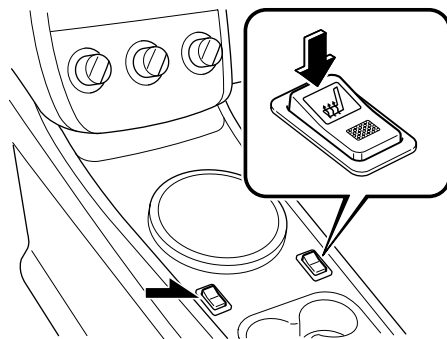



**NOTE**

*The seat temperature is regulated automatically by a thermostat. Other than turning it on or off, it cannot be adjusted.*

**Front Seats (Electrically Operated Seats)**

**⚠ WARNING**

**Do not modify or replace the front seats:**

*Modifying or replacing the front seats such as replacing the upholstery or loosening any bolts is dangerous. The front seats contain air bag components essential to the supplemental restraint system. Such modifications could damage the supplemental restraint system and result in serious injury. Consult an Authorized Mazda Dealer if there is any need to remove or reinstall the front seats.*

**Do not drive with damaged front seats:**

*Driving with damaged front seats is dangerous. A collision, even one not strong enough to inflate the air bags, could damage the front seats which contain essential air bag components. If there was a subsequent collision, an air bag may not deploy which could lead to injuries. Always have an Authorized Mazda Dealer inspect the front seats, front seat belt pretensioners and air bags after a collision.*

Essential Safety Equipment

## Seats

### **⚠ CAUTION**

- *The seat-bottom power adjustment is operated by motors. Avoid extended operation because excessive use can damage the motors.*
- *To prevent the battery from running down, avoid using the power adjustment when the engine is stopped. The adjuster uses a large amount of electrical power.*
- *Don't use the switch to make more than one adjustment at a time.*

### ▼ Seat Slide

To slide the seat, move the slide lifter switch on the outside of the seat to the front or back and hold it. Release the switch at the desired position.

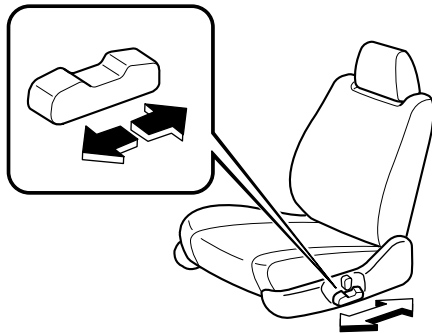

### ▼ Seat Recline

### **⚠ WARNING**

**Do not drive with the seats reclined:**

*Sitting in a reclined position while the vehicle is moving is dangerous because you don't get the full protection from seat belts. During sudden braking or a collision, you can slide under the lap belt and suffer serious internal injuries. For maximum protection, sit well back and upright.*

**Always sit in a front passenger seat properly with the seatback upright and feet on the floor:**

*If your vehicle is equipped with front passenger seat weight sensors, sitting in the front passenger seat improperly out of position or with the seatback reclined too far while the vehicle is moving is dangerous as it can take off weight from the seat bottom and affect the weight determination of the front passenger sensing system. As a result the front passenger will not have the supplementary protection of the air bag and seat belt pretensioner, which could cause result in serious injury. Always sit upright against your seatback, with your feet on the floor.*

Essential Safety Equipment  
**Seats**

Change the seatback angle by pressing the front or rear side of the reclining switch. Release the switch at the desired position.

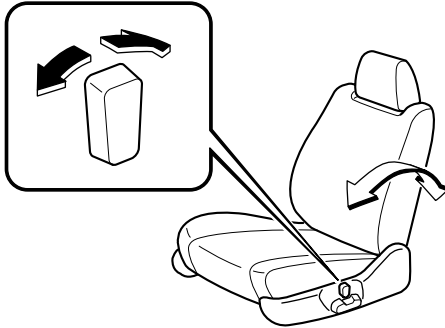

▼ **Height Adjustment**

The seat height can be adjusted by moving the switch up or down.

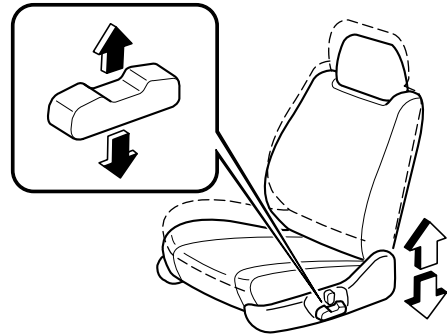
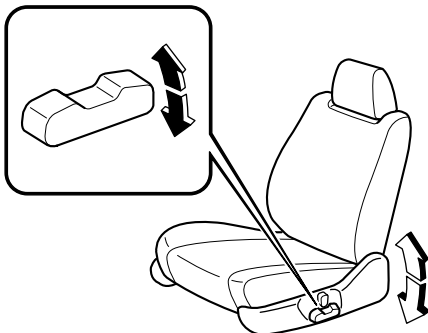
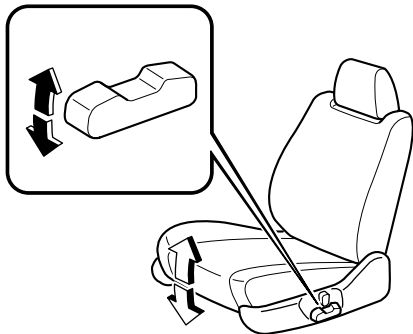

▼ **Lumbar Support Adjustment**

To increase the seat firmness, pull the lever forward. Push the lever backward to decrease firmness.

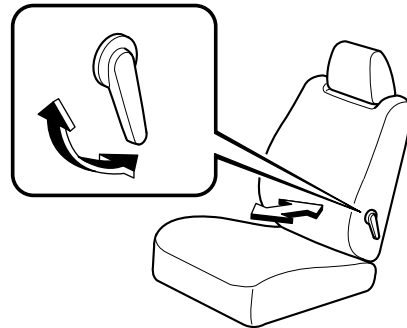

▼ **Head Restraint**

**⚠ WARNING**

*Always drive with the head restraints installed when seats are being used and make sure they are properly adjusted:*

*Driving with the head restraints adjusted too low or removed is dangerous. With no support behind your head, your neck could be seriously injured in a collision.*

Essential Safety Equipment

## Seats

### Height adjustment

To raise a head restraint, pull it up to the desired position.

To lower the head restraint, press the stop-catch release, then push the head restraint down.

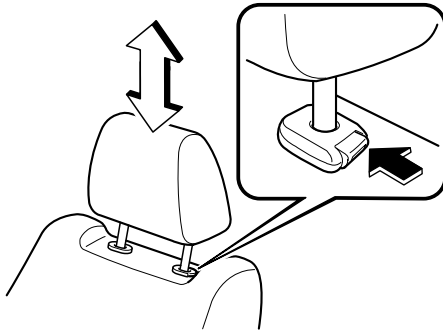

Adjust the head restraint so that the top is even with the top of the passenger's ears, never the passenger's neck to prevent injury.

### ▼ Seat Warmer \*

The front seats are electrically heated. The ignition switch must be in the ON position.

Press the switch to turn the seat warmer on or off. When the switch is in the ON position, the indicator light will come on.

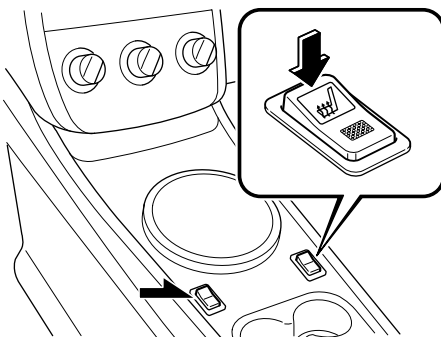

### **NOTE**

*The seat temperature is regulated automatically by a thermostat. Other than turning it on or off, it cannot be adjusted.*

2-8 \*Some models.

## Rear Seat

### **! WARNING**

**Do not stack cargo higher than the seatbacks:**

*Stacking luggage or other cargo higher than the seatbacks, and placing articles on the rear seat is dangerous. During sudden braking or a collision, objects can fly around and become projectiles that may hit and injure passengers.*

**Make sure luggage and cargo is secured before driving:**

*Not securing cargo while driving is dangerous as it could move or be crushed during sudden braking or a collision and cause injury.*

**Make sure the adjustable components of a seat are locked in place:**

*Adjustable seats that are not securely locked are dangerous. In a sudden stop or collision, the seat or seatback could move, causing injury.*

**Do not drive with the seatback unlocked:**

*The seatback plays an important role in your protection in a vehicle. Leaving the seatback unlocked is dangerous as it can allow passengers to be ejected or thrown around and baggage to strike occupants in a sudden stop or collision, resulting in severe injury. After returning the seatback at any time, even when there are no other passengers, rock the seatback to make sure it is locked in place.*

**Never allow a passenger to sit or stand on the folded seatback while the vehicle is moving:**

*Driving with a passenger on the folded seatback is dangerous. Allowing a child to sit up on the folded seatback while the vehicle is moving is particularly dangerous. In a sudden stop or even a minor collision, a child not in a proper seat or child-restraint system and seat belt could be thrown forward, back or even out of the vehicle resulting in serious injuries or death. The child in the baggage area could be thrown into other occupants and cause serious injury.*

### **NOTE**

*When returning a rear seat to its original position, also replace the seat belt to its normal position. Verify that the seat belt pulls out and retracts.*

Essential Safety Equipment

## Seats

### ▼ Split-Folding Rear Seatback

The seatbacks can be folded down to provide more space in the luggage compartment.

#### To fold the seatbacks

#### **⚠ WARNING**

**Always remove the child-restraint system from the rear seat before operating the remote handle levers for the rear seat:**

*Operating the remote handle levers while a rear-facing child-restraint system is in the rear seat is dangerous. It could cause injury to a child seated in the child-restraint system when the seatback suddenly flips forward.*

**Make sure there is nobody in the rear seat area before operating the remote handle levers:**

*Not checking the rear seat area for persons before folding the seatbacks with the remote handle levers is dangerous. The rear seat area is difficult to see from the rear of the vehicle. Operating the remote handle levers without checking could cause injury to a person when a seatback suddenly flips forward.*

#### **⚠ CAUTION**

*Before folding the seatbacks with the remote handle levers, make sure there is no cup in a rear cup holder. Folding the seatbacks with the remote handle levers while a cup is in the cup holder could soil or damage the seat bottom and seatback.*

### When using the remote handle levers:

#### **⚠ CAUTION**

*Be careful of the following when using the remote handle levers:*

- *On a downward slope, the seatback could flip forward faster than on a flat area.*
- *On an upward slope, the seatback may not fold down. When the seatbacks cannot be folded down with levers, pull the rear seatback forward from inside the vehicle.*

1. Unfasten the lap portion of the center-rear seat belt (page 2-22).

#### **⚠ CAUTION**

*Always unfasten the lap portion of the belt before folding left-rear seatback. Leaving the lap portion of the belt fastened could cause damage to the seat belt, buckle and seatback.*

2. After checking that the rear seats are clear, open the liftgate compartment and pull the remote handle levers on the left and right side of the liftgate compartment.

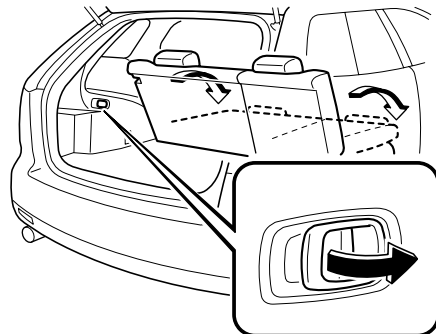

Essential Safety Equipment  
**Seats**

**When using the rear seatback knobs:**

**⚠ CAUTION**

*When operating the rear seatback knob, make sure you support the seatback with your hand. If the seatback is not supported with your hand, it will flip forward suddenly and could cause injury to the finger that pushes the rear seatback knob down.*

1. Unfasten the lap portion of the center-rear seat belt (page 2-22).

**⚠ CAUTION**

*Always unfasten the lap portion of the belt before folding the rear-left seatback. Leaving the lap portion of the belt fastened could cause damage to the seat belt, buckle and seatback.*

2. Support the seatback with your hand.
3. Push the rear seatback knob down.

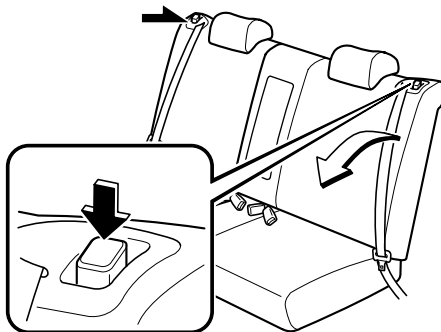

**To return the seatbacks to the upright position**

1. Lift the seatbacks upright.

2. Pull on the top of the seatbacks from inside the vehicle to make sure they are locked.
3. Fasten the center-rear lap/shoulder belt and check that all seat belts are routed properly for passenger use (page 2-22).

**⚠ WARNING**

**Always make sure the seat belts are fully pulled out from under the seatbacks:**

*A seat belt caught under a seatback after the seatback is returned to its upright position is dangerous. In a collision or sudden stop, the seat belt cannot provide adequate protection.*

**When returning the seatback to the upright position, make sure there is no red indication:**

*A rear seatback not fully returned and locked in the upright position is dangerous. Sudden stops or maneuvering could cause a seatback to flip forward suddenly resulting in injury. If the red indicator is visible on the back of the rear seatback knob, the seatback is not locked in the upright position.*

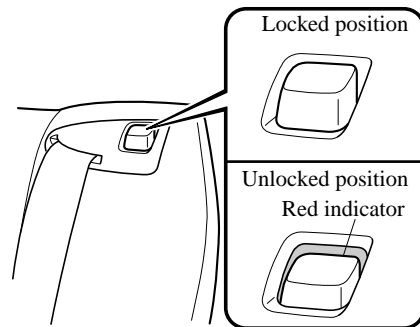

Essential Safety Equipment

## Seats

### ▼ Head Restraint

#### **⚠ WARNING**

***Always drive with the head restraints installed when seats are being used and make sure they are properly adjusted:***

*Driving with the head restraints adjusted too low or removed is dangerous. With no support behind your head, your neck could be seriously injured in a collision.*

#### **Height adjustment**

To use a head restraint, pull it up to the locked position.

To lower the head restraint, press the stop-catch release, then push the head restraint down.

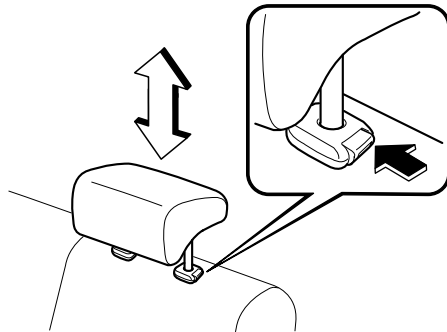

Adjust the head restraint so that the top is even with the top of the passenger's ears, never the passenger's neck to prevent injury.

### ▼ Armrest

The rear armrest in the center of the rear seatback can be used (no occupant in the center seat) or placed upright.

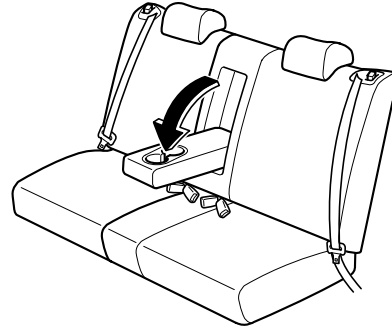



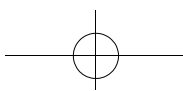

Essential Safety Equipment  
**Seat Belt Systems**

---

### Seat Belt Precautions

Seat belts help to decrease the possibility of severe injury during accidents and sudden stops. Mazda recommends that the driver and all passengers always wear seat belts.

All of the seat belt retractors are designed to keep the lap/shoulder belts out of the way when not in use.

The driver's seat belt has no provisions for child-restraint systems and has only an emergency locking mode. The driver may wear it comfortably, and it will lock during a collision.

However, the front passenger's seat and all rear lap/shoulder belt retractors operate in two modes: emergency locking mode, and for child-restraint systems, automatic locking mode. While we recommend you put all children in the rear seats, if you must use the front passenger seat for a child, slide the front passenger seat as far back as possible and make sure any child-restraint system is secured properly.

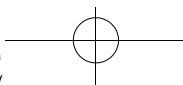

Essential Safety Equipment

## Seat Belt Systems

---

### **WARNING**

**Always wear your seat belt and make sure all occupants are properly restrained:**

*Not wearing a seat belt is extremely dangerous. During a collision, occupants not wearing seat belts could hit someone or things inside the vehicle or even be thrown out of the vehicle. They could be seriously injured or even killed. In the same collision, occupants wearing seat belts would be much safer.*

**Do not wear twisted seat belts:**

*Twisted seat belts are dangerous. In a collision, the full width of the belt is not available to absorb the impact. This puts more force on the bones beneath the belt, which could cause serious injury or death.*

**Never use one seat belt on more than one person at a time:**

*Using one seat belt for more than one person at a time is dangerous. A seat belt used in this way cannot spread the impact forces properly and the two passengers could be crushed together and seriously injured or even killed. Never use one belt for more than one person at a time and always operate the vehicle with each occupant properly restrained.*

**Do not operate a vehicle with a damaged seat belt:**

*Using a damaged seat belt is dangerous. An accident could damage the belt webbing of the seat belt in use. A damaged seat belt cannot provide adequate protection in a collision. Have an Authorized Mazda Dealer inspect all seat belt systems in use during an accident before they are used again.*

**Have your seat belts changed immediately if the pretensioner or load limiter has been expended:**

*One or both front air bags may deploy, and the corresponding pretensioner(s) may also deploy at the same time. While it is safer to use a crash-used seat belt that was used in an accident than no seat belt at all, using a seat belt with an expended pretensioner or load limiter loaded reduces the safety available to you. Like the air bags, the seat belt pretensioners will only function once. After they are expended, they will not function again and must be replaced immediately. If the seat belt pretensioners are not replaced, the risk of injury in a collision will increase. Always have an Authorized Mazda Dealer inspect the seat belt pretensioners and air bags after any collision. Expended seat belt pretensioners and air bags must be replaced after any collision which caused them to deploy. Additionally, the load limiter will only limit loads on the chest once in a collision and this is another reason to have the front seat belts inspected.*

*In a rollover crash, an unbelted person is significantly more likely to die than a person wearing a seat belt.*

Essential Safety Equipment  
**Seat Belt Systems**

**CAUTION**

*Belt retraction may become difficult if the belts and rings are soiled, so try to keep them clean. For more details about cleaning the seat belts, refer to "Cleaning the Lap/Shoulder Belt Webbing" (page 8-56).*

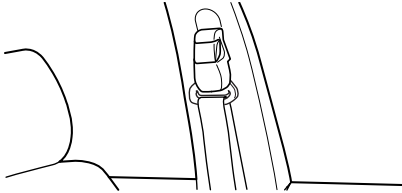

**▼ Pregnant Women and Persons with Serious Medical Conditions**

Pregnant women should always wear seat belts. Ask your doctor for specific recommendations.

The lap belt should be worn **SNUGLY AND AS LOW AS POSSIBLE OVER THE HIPS**. The shoulder belt should be worn across your shoulder properly, but never across the stomach area.

Persons with serious medical conditions also should wear seat belts. Check with your doctor for any special instructions regarding specific medical conditions.



**▼ Emergency Locking Mode**

In the emergency locking mode, the belt remains comfortable on the occupant and the retractor will lock in position during a collision. When the seat belt is fastened, it will always be in the emergency locking mode until it is switched to automatic locking mode by pulling it all the way out to its full length. If the belt feels tight and hinders comfortable movement while the vehicle is stopped or in motion, it may be in the automatic locking mode because the belt has been pulled too far out. To return the belt to the more comfortable emergency locking mode, wait until the vehicle has stopped in a safe, level area, retract the belt fully to convert it back to emergency locking mode and then extend it around you again.

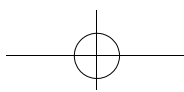

Essential Safety Equipment

## Seat Belt Systems

---

### ▼ Automatic Locking Mode

Always use the automatic locking mode to keep the child-restraint system from shifting to an unsafe position in the event of an accident. To enable seat belt automatic locking mode, pull it all the way out and connect it as instructed on the child-restraint system. It will retract down to the child-restraint system and stay locked on it. See the section on child restraint (page 2-28).

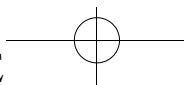

Essential Safety Equipment  
**Seat Belt Systems**

### Seat Belt (Except Center-Rear Position)

**NOTE**

When using the center-rear seat belt, refer to "Center-Rear Position Seat Belt" (page 2-22).

▼ **Fastening the Seat Belt**

1. Grasp the tongue.
2. Slowly pull out the lap/shoulder belt.

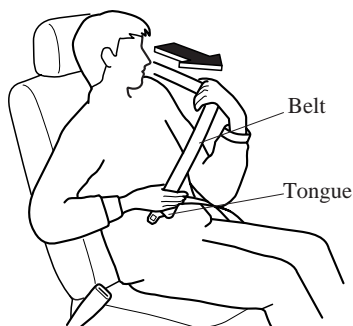

3. Insert the tongue into the buckle until you hear a click.

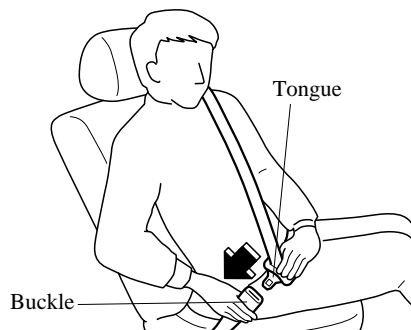

**WARNING**

**Positioning the Shoulder Portion of the Seat Belt:**

*Improper positioning of the shoulder portion of the seat belt is dangerous. Always make sure the shoulder portion of the seat belt is positioned across your shoulder and near your neck, but never under your arm, on your neck, or on your upper arm.*

4. Position the lap belt as low as possible, not on the abdominal area, then adjust the shoulder belt so that it fits snugly against your body.

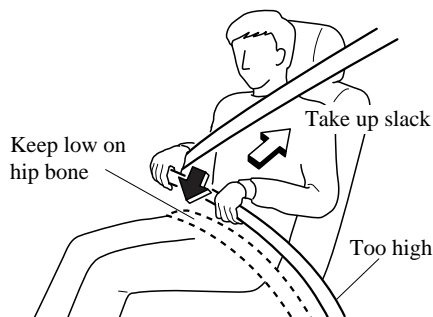

**WARNING**

**Positioning the Lap Portion of the Seat Belt:**

*The lap portion of the seat belt worn too high is dangerous. In a collision, this would concentrate the impact force directly on the abdominal area, causing serious injury. Wear the lap portion of the belt snugly and as low as possible.*

Essential Safety Equipment

## Seat Belt Systems

### ▼ Unfastening the Seat Belt

Depress the button on the buckle. If the belt does not fully retract, pull it out and check for kinks or twists. Then make sure it remains untwisted as it retracts.

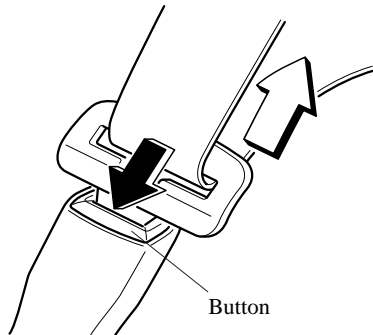

#### **NOTE**

*If a belt does not fully retract, inspect it for kinks and twists. If it is still not retracting properly, have it inspected at an Authorized Mazda Dealer.*

### ▼ Shoulder Belt Adjuster

Adjust the height of the shoulder belt if the seat belt touches your neck, or if it crosses your arm instead of your shoulder. To raise the shoulder belt adjuster, push the adjuster up. To lower the shoulder belt adjuster, pull the adjuster and slide it down. Make sure the adjuster is locked.

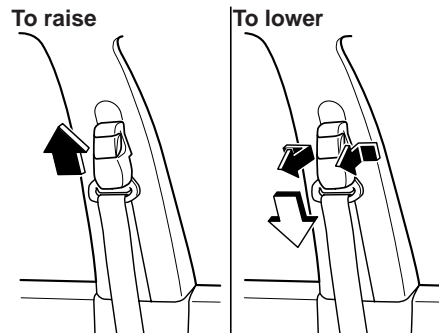

#### **! WARNING**

#### **Positioning the Shoulder Portion of the Seat Belt:**

*Improper positioning of the shoulder portion of the seat belt is dangerous. Always make sure the shoulder portion of the seat belt is positioned across your shoulder and near your neck, but never under your arm, on your neck, or on your upper arm.*

Essential Safety Equipment  
**Seat Belt Systems**

### Front Seat Belt Pretensioner and Load Limiting Systems

For optimum protection, the driver and front passenger seat belts are equipped with pretensioner and load limiting systems. For both these systems to work properly you must wear the seat belt properly.

#### **Pretensioners:**

The front seat belt retractors remove slack quickly as the air bags are expanding. For deployment details, refer to the SRS Air Bag Deployment Criteria (page 2-57). In addition, the pretensioner system for the front passenger, like the front passenger air bag, is designed to only deploy in accordance with the total seated weight on the front passenger seat. Any time the air bags and seat belt pretensioners have fired they must be replaced. For details, refer to the driver and front passenger occupant classification system (page 2-60).

#### **Load limiter:**

The load limiting system releases belt webbing in a controlled manner to reduce belt force on the occupant's chest. While the most severe load on a seat belt occurs in frontal collisions, the load limiter has an automatic mechanical function and can activate in any accident mode with sufficient occupant movement. Even if the pretensioners have not fired, the load limiting function must be checked by an Authorized Mazda Dealer.

### **⚠ WARNING**

***Wear seat belts only as recommended in this owner's manual:***

*Incorrect positioning of the driver and front passenger seat belts is dangerous. Without proper positioning, the pretensioner and load limiting systems cannot provide adequate protection in an accident and this could result in serious injury. For more details about wearing seat belts, refer to "Fastening the seat belts" (page 2-17).*

Essential Safety Equipment

## Seat Belt Systems

**Have your seat belts changed immediately if the pretensioner or load limiter has been expended:**

One or both front air bags may deploy, and the corresponding pretensioner(s) may also deploy at the same time. While it is safer to use a crash-used seat belt that was used in an accident than no seat belt at all, using a seat belt with an expended pretensioner or load limiter loaded reduces the safety available to you. Like the air bags, the seat belt pretensioners will only function once. After they are expended, they will not function again and must be replaced immediately. If the seat belt pretensioners are not replaced, the risk of injury in a collision will increase. Always have an Authorized Mazda Dealer inspect the seat belt pretensioners and air bags after any collision. Expended seat belt pretensioners and air bags must be replaced after any collision which caused them to deploy. Additionally, the load limiter will only limit loads on the chest once in a collision and this is another reason to have the front seat belts inspected.

**Do not modify the components or wiring, or use electronic testing devices on the pretensioner system:**

Modifying the components or wiring of the pretensioner system, including the use of electronic testing devices is dangerous. You could accidentally activate it or make it inoperable which would prevent it from activating in an accident. The occupants or repairers could be seriously injured.

**Properly dispose of the pretensioner system:**

Improper disposal of the pretensioner system or a vehicle with non-deactivated pretensioners is dangerous. Unless all safety procedures are followed, injury could result. Ask an Authorized Mazda Dealer how to safely dispose of the pretensioner system or how to scrap a pretensioner-equipped vehicle.

**NOTE**

- The pretensioner system will activate in a moderate or severe frontal, near-frontal collision or roll-over accident. The pretensioner system for the front passenger is designed to only deploy in accordance with the total seated weight on the front passenger seat. It will not activate in most side or rear impacts.
- Some smoke (non-toxic gas) will be released when the air bags and pretensioners deploy. This does not indicate a fire. This gas normally has no effect on occupants, however, those with sensitive skin may experience light skin irritation. If residue from the deployment of the air bags or the front pretensioner system gets on the skin or in the eyes, wash it off as soon as possible.



Essential Safety Equipment  
**Seat Belt Systems**

▼ **Air Bag/Front Seat Belt  
Pretensioner System Warning Light**



If the air bag/front seat belt pretensioner system is working properly, the warning light illuminates when the ignition switch is turned to the ON position or after the engine is cranked. The warning light turns off after a specified period of time.

A system malfunction is indicated if the warning light constantly flashes, constantly illuminates or does not illuminate at all when the ignition switch is turned to the ON position. If any of these occur, consult an Authorized Mazda Dealer as soon as possible. The system may not work in an accident.

**⚠ WARNING**

**Never tamper with the air bag/pretensioner systems and always have an Authorized Mazda Dealer perform all servicing and repairs:**

*Self-servicing or tampering with the systems is dangerous. An air bag/pretensioner could accidentally activate or become disabled causing serious injury or death.*

▼ **Air Bag/Front Seat Belt  
Pretensioner System Warning Beep**

If a malfunction is detected in both the air bag/front seat belt pretensioner system and the warning light, a warning beep sound will be heard for about 1 minute. After that, the one-minute beep will be repeated every 30 minutes.

Have your vehicle inspected at an Authorized Mazda Dealer as soon as possible.

**⚠ WARNING**

**Do not drive the vehicle with the air bag/front seat belt pretensioner system warning beep sounding:**

*Driving the vehicle with the air bag/front seat belt pretensioner system warning beep sounding is dangerous. In a collision, the air bags and the front seat belt pretensioner system will not deploy and this could result in death or serious injury.*

*Contact an Authorized Mazda Dealer to have the vehicle inspected as soon as possible.*

Essential Safety Equipment

## Seat Belt Systems

### Center-Rear Position Seat Belt

Before using the center-rear lap/shoulder belt make sure tongue (A) and anchor buckle (B) are fastened.

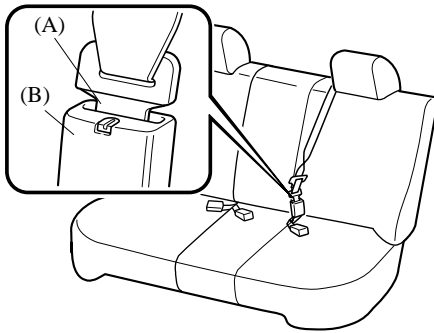

#### ▼ Fastening the Seat Belt

1. Grasp the tongue (C).
2. Slowly pull out the lap/shoulder belt.
3. Insert the tongue (C) into the buckle (D) until you hear a click.

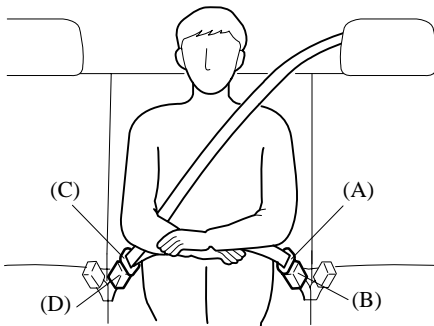

#### **⚠ WARNING**

##### **Fastening the Center-Rear Seat Belt with Only One Buckle:**

*Fastening the center-rear seat belt with only one buckle is dangerous. If only one pair of seat belt tongue and buckle, either tongue (A) and anchor buckle (B) or tongue (C) and anchor buckle (D), is fastened, the seat belt cannot provide full protection. In a sudden stop or collision, the user could slide under the belt and suffer serious injuries. Always make sure that both pairs of seat belt tongues and buckles are fastened properly.*

##### **Positioning the Shoulder Portion of the Seat Belt:**

*Improper positioning of the shoulder portion of the seat belt is dangerous. Always make sure the shoulder portion of the seat belt is positioned across your shoulder and near your neck, but never under your arm, on your neck, or on your upper arm.*

4. Position the lap belt as low as possible, not on the abdominal area, then adjust the shoulder belt so that it fits snugly against your body.

#### **⚠ WARNING**

##### **Positioning the Lap Portion of the Seat Belt:**

*The lap portion of the seat belt worn too high is dangerous. In a collision, this would concentrate the impact force directly on the abdominal area, causing serious injury. Wear the lap portion of the belt snugly and as low as possible.*

Essential Safety Equipment  
**Seat Belt Systems**

▼ **Unfastening the Seat Belt**

Depress the button on the buckle. If the belt does not fully retract, pull it out and check for kinks or twists. Then make sure it remains untwisted as it retracts.

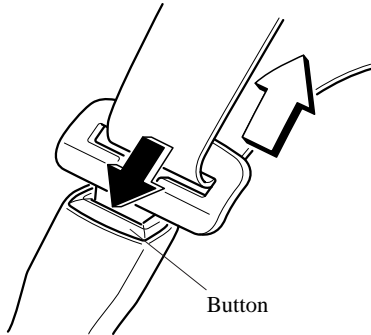

**NOTE**

*If a belt does not fully retract, inspect it for kinks and twists. If it is still not retracting properly, have it inspected at an Authorized Mazda Dealer.*

▼ **Unfastening the Lap Portion of the Seat Belt**

Insert a small object such as a key in the anchor buckle (B) slot.

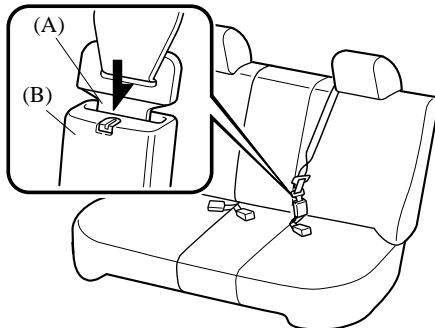

**CAUTION**

*Always unfasten the lap portion of the belt before folding the left-rear seatback. Leaving the lap portion of the belt fastened could cause damage to the seat belt, buckle and seatback.*

**NOTE**

*To encourage rear seat passengers to wear their seat belts, we suggest leaving the center-rear lap position of the belt fastened at all times except when folding the rear seat forward.*

▼ **Fastening the Lap Portion of the Seat Belt**

Grasp tongue (A) and insert it into the anchor buckle (B) until you hear a click. It is now secure for passenger use.

**NOTE**

*After returning the left-rear seatback to its upright position, fasten the lap portion of the belt.*

▼ **Stowing and pulling out the Center-Rear Position Seat Belt**

The center-rear position seat belt can be stowed using the following procedure.

**CAUTION**

*When stowing the seat belt, make sure the belt is locked securely into the recess. If the seat belt is not properly stowed, it might get caught in the seats and be damaged.*

Essential Safety Equipment

## Seat Belt Systems

To stow the seat belt, retract the belt, put tongues (A) and (C) together and insert them into the recess.

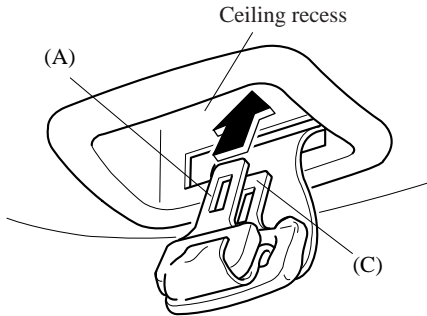

To pull out the seat belt, slide tongue (A) with your finger while moving it downward, and slowly pull out the seat belt from the ceiling recess.

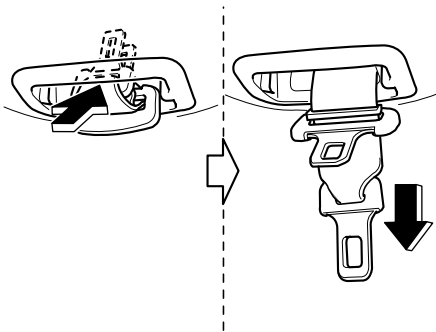

**NOTE**

*Pulling out the seat belt all the way out will switch it to automatic locking mode. If automatic locking mode is not needed, retract the seat belt fully to convert it back to emergency locking mode.*

## Seat Belt Extender

If your seat belt is not long enough, even when fully extended, a seat belt extender may be available to you at no charge from your Authorized Mazda Dealer.

This extender will be only for you and for the particular vehicle and seat. Even if it plugs into other seat belts, it may not hold in the critical moment of a crash.

When ordering an extender, only order one that provides the necessary additional length to fasten the seat belt properly. Please contact your Authorized Mazda Dealer for more information.

Essential Safety Equipment  
**Seat Belt Systems**

**⚠ WARNING**

**Do not use a seat belt extender unless it is necessary:**

*Using a seat belt extender when not necessary is dangerous. The seat belt will be too long and not fit properly. In an accident, the seat belt will not provide adequate protection and you could be seriously injured. Only use the extender when it is required to fasten the seat belt properly.*

**Do not use an improper extender:**

*Using a seat belt extender that is for another person or a different vehicle or seat is dangerous. The seat belt will not provide adequate protection and the user could be seriously injured in an accident. Only use the extender provided for you and for the particular vehicle and seat. NEVER use the extender in a different vehicle or seat.*

**Do not use an extender that is too long:**

*Using an extender that is too long is dangerous. The seat belt will not fit properly. In an accident, the seat belt will not provide adequate protection and you could be seriously injured. Do not use the extender or choose one shorter in length if the distance between the extender's buckle and the center of the user's body is less than 15cm (6 in).*

**NOTE**

*When not in use, remove the seat belt extender and store it in the vehicle. If the seat belt extender is left connected, the seat belt extender might get damaged as it will not retract with the rest of the seat belt and can easily fall out of the door when not in use and be damaged. In addition, the seat belt warning light will not illuminate and function properly.*

Essential Safety Equipment

# Seat Belt Systems

## Seat Belt Warning Light/Beep



The seat belt warning light illuminates and a beep sound will be heard if the driver's seat belt is not fastened when the ignition switch is turned to the ON position.

### Conditions of operation

Condition	Result
The driver's seat belt is not fastened when the ignition switch is turned to the ON position.	The warning light flashes and a beep sound will be heard for about 6 seconds.
The driver's seat belt is fastened while the warning light and the beep sound are activated.	The warning light turns off and the beep sound stops.
The driver's seat belt is fastened before the ignition switch is turned to the ON position.	The warning light will not illuminate and the beep sound will not be heard.

### ▼ Belt Minder

#### NOTE

The belt minder can be deactivated. Consult an Authorized Mazda Dealer to deactivate and restore the seat belt minder.

### Driver seated/Front passenger not seated

The belt minder is a supplemental warning to the seat belt warning function. If the driver's seat belt is not fastened when the ignition switch is turned to the ON position, the warning light/beep operates to give you further reminders according to the chart below.

Condition	Vehicle speed			
	Between 0 — 20 km/h (0 — 12 mph)		20 km/h (12 mph) or more	
Seat belt	○	×	○	×
Indicator		⚡		⚡
Beep				🎵

- : Fastened
- ×
- ⚡ : Illuminated
- ⚡ : Flashing
- 🎵 : Beep

Once the beep sound is heard, it continues sounding even if the vehicle speed lowers to 20 km/h (12 mph) or less until the seatbelt is fastened or the beep sound period has passed.

Essential Safety Equipment  
**Seat Belt Systems**

**Driver seated/Front passenger seated**

The seat belt warning function reminds the front passenger to fasten the seat belt according to the chart below.

Condition	Vehicle speed							
	Between 0 — 20 km/h (0 — 12 mph)				20 km/h (12 mph) or more			
Seat belt (Driver)	○	○	×	×	○	○	×	×
Seat belt (Passenger)	○	×	○	×	○	×	○	×
Indicator			⦿	⦿		⦿	⦿	⦿
Beep						♪	♪	♪

- : Fastened
- × : Unfastened
- ⦿ : Illuminated
- ⦿ : Flashing
- ♪ : Beep

Placing heavy items on the front passenger seat may cause the front passenger seat belt warning function to operate depending on the weight of the item.

Once the beep sound is heard, it continues sounding even if the vehicle speed lowers to 20 km/h (12 mph) or less until the seatbelt is fastened or the beep sound period has passed.

**NOTE**

- *To allow the front passenger seat weight sensor to function properly, do not place and sit on an additional seat cushion on the front passenger seat. The sensor may not function properly because the additional seat cushion could cause sensor interference.*
- *When a small child sits on the front passenger seat, it is possible that neither the warning light nor the warning beep operate.*

Essential Safety Equipment

## Child Restraint

### Child Restraint Precautions

Mazda strongly urges the use of child-restraint systems for children small enough to use them.

You are required by law to use a child-restraint system for children in the U.S. and Canada. Check your local and state or provincial laws for specific requirements regarding the safety of children riding in your vehicle.

Whatever child-restraint system you consider, please pick the appropriate one for the age and size of the child, obey the law and follow the instructions that come with the individual child-restraint system.

A child who has outgrown child-restraint systems should sit in the rear and use seat belts, both lap and shoulder. If the shoulder belt crosses the neck or face, move the child closer to the center of the vehicle in the outboard seats, and towards the buckle on the right if the child is seated on the center seat.

Statistics confirm that the rear seat is the best place for all children up to 12 years of age, and more so with a supplemental restraint system (air bags).

A rear-facing child-restraint system should **NEVER** be used on the front seat with the air bag system activated. The front passenger's seat is also the least preferred seat for other child-restraint systems.

To reduce the chance of injuries caused by deployment of the front passenger air bag, your vehicle is equipped with the front passenger seat weight sensors. These sensors deactivate the front passenger front and side air bags and also the front passenger seat belt pretensioner system when the total seated weight on the front passenger seat is less than approximately 30 kg (66 lb).

When an infant or small child sits on the front passenger seat, the system shuts off the front passenger air bag, so make sure the front passenger air bag deactivation indicator light illuminates.

Even if the front passenger air bag is shut off, Mazda strongly recommends that children be properly restrained and child-restraint systems of all kinds are properly secured on the rear seats which are the best place for children.

For more details, refer to "Front passenger seat weight sensors" (page 2-60).



Essential Safety Equipment  
**Child Restraint**

**⚠ WARNING**

**Use the correct size child-restraint system:**

*For effective protection in vehicle accidents and sudden stops, a child must be properly restrained using a seat belt or child-restraint system depending on age and size. If not, the child could be seriously injured or even killed in an accident.*

**Follow the manufacturer's instructions and always keep the child-restraint system buckled down:**

*An unsecured child-restraint system is dangerous. In a sudden stop or a collision it could move causing serious injury or death to the child or other occupants. Make sure any child-restraint system is properly secured in place according to the child-restraint system manufacturer's instructions. When not in use, remove it from the vehicle or fasten it with a seat belt, or latch it down to BOTH LATCH lower anchors for LATCH child-restraint systems, and attach the corresponding tether anchor.*

**Always secure a child in a proper child-restraint system:**

*Holding a child in your arms while the vehicle is moving is extremely dangerous. No matter how strong the person may be, he or she cannot hold onto a child in a sudden stop or collision and it could result in serious injury or death to the child or other occupants. Even in a moderate accident, the child may be exposed to air bag forces that could result in serious injury or death to the child, or the child may be slammed into an adult, causing injury to both child and adult.*

**Never use a rear-facing child-restraint system in the front seat with an air bag that could deploy:**

*Rear-facing child-restraint systems on the front seat are particularly dangerous even though you may feel assured that a front passenger air bag will not deploy based on the fact that the front passenger air bag deactivation indicator light illuminates. The child-restraint system can be hit by a deploying air bag and moved violently backward resulting in serious injury or death to the child.*

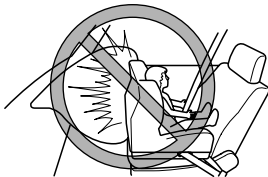

Essential Safety Equipment

## Child Restraint

**Do not install a front-facing child-restraint system on the front passenger seat unless it is unavoidable:**

*In a collision, the force of a deploying air bag could cause serious injury or death to the child. If installing a front-facing child-restraint system on the front passenger seat is unavoidable, move the front passenger seat as back as possible.*



**Seating a child in a child-restraint system on the front passenger seat is dangerous:**

*Your vehicle is equipped with front passenger seat weight sensors. Even with front passenger seat weight sensors, if you must use the front passenger seat to seat a child, using a child-restraint system on the front passenger seat under the following conditions increases the danger of the front passenger air bag deploying and could result in serious injury or death to the child.*

- *The total seated weight of the child with the child-restraint system on the front passenger seat is approximately 30 kg (66 lb) or more with a child in the child-restraint system.*
- *Luggage or other items are placed on the seat with the child in the child-restraint system.*
- *A rear passenger or luggage pushing or pulling down on the front passenger seatback.*
- *A rear passenger puts their feet on the front seat rails.*
- *Luggage or other items are placed on the seatback or hung on the head restraint.*
- *The seat is washed.*
- *Liquids are spilled on the seat.*
- *The front passenger seat is moved backward, pushing into luggage or other items placed behind it.*
- *The front passenger seatback contacts the rear seat.*
- *Luggage or other items are placed between the front passenger seat and driver seat.*
- *Any accessories increasing the total seated weight on the front passenger seat are attached to the front passenger seat.*

*The designated positions with seat belts on the rear seats are the safest places for children. Always use seat belts and child restraints.*

Essential Safety Equipment  
**Child Restraint**

---

**Do not allow a child to lean over or against the side window of a vehicle with side and curtain air bags:**

*It is dangerous to allow anyone to lean over or against the side window, the area of the front passenger seat, the front and rear window pillars and the roof edge along both sides from which the side and curtain air bags deploy, even if a child-restraint system is used. If the vehicle is equipped with side and curtain air bags, the impact of inflation could cause serious injury or death to the child. Furthermore, leaning over or against the front door could block the side and curtain air bags and eliminate the advantages of supplemental protection. With the front air bag and the additional side air bag that comes out of the front seat, the rear seat is always a better location for children. Do not allow a child to lean over or against the side window, even if the child is seated in a child-restraint system.*

**Never use one seat belt on more than one person at a time:**

*Using one seat belt for more than one person at a time is dangerous. A seat belt used in this way cannot spread the impact forces properly and the two passengers could be crushed together and seriously injured or even killed. Never use one belt for more than one person at a time and always operate the vehicle with each occupant properly restrained.*

**Always remove the child-restraint system from the rear seat before operating the remote handle levers for the rear seat:**

*Operating the remote handle levers while a rear-facing child-restraint system is in the rear seat is dangerous. It could cause injury to a child seated in the child-restraint system when the seatback suddenly flips forward.*

**⚠ CAUTION**

*A seat belt or child-restraint system can become very hot in a closed vehicle during warm weather. To avoid burning yourself or a child, check them before you or your child touches them.*

**NOTE**

*Your Mazda is equipped with LATCH lower anchors for attachment of specially designed LATCH child-restraint systems in the rear seat. When using these anchors to secure a child-restraint system, refer to "LATCH Child-Restraint Systems" (page 2-41).*

Essential Safety Equipment

## Child Restraint

### Installing Child-Restraint Systems

Accident statistics reveal that a child is safer in the rear seat. The front passenger's seat is clearly the worst choice for any child under 12, and with rear-facing child-restraint systems it is clearly unsafe due to air bags.

Some child-restraint systems now come with tethers and therefore must be installed on the seats that take tethers to be effective. In your Mazda, tethered child-restraint systems can only be accommodated in the three positions on the rear seat.

Even if your vehicle is equipped with front passenger seat weight sensors (page 2-60), which automatically deactivates the front passenger air bag, a rear seat is the safest place for a child of any age or size.

Some child-restraint systems also employ specially designed LATCH attachments; refer to "LATCH Child-Restraint Systems" (page 2-41).

#### **⚠ WARNING**

#### **Tethered Child-Restraint Systems Work Only on Tether-Equipped Rear Seats:**

*Installation of a tether equipped child-restraint system in the front passenger's seat defeats the safety design of the system and will result in an increased chance of serious injury if the child-restraint system goes forward without benefit of being tethered.*

*Place tether equipped child-restraint systems where there are tether anchors.*

### ▼ Rear Outboard Seat Child-Restraint System Installation

Follow these instructions when using a child-restraint system, unless you are attaching a LATCH-equipped child-restraint system to the rear LATCH lower anchors. Refer to "LATCH Child-Restraint Systems" (page 2-41).

#### **NOTE**

*Follow the child-restraint system manufacturer's instructions carefully. If you are not sure whether you have a LATCH system or tether, check in the child-restraint system manufacturer's instructions and follow them accordingly. Depending on the type of child-restraint system, it may not employ seat belts which are in automatic locking mode.*

1. Make sure the seatback is securely latched by pushing it back until it is fully locked.
2. Secure the child-restraint system with the lap portion of the lap/shoulder belt. See the manufacturer's instructions on the child-restraint system for belt routing instructions.
3. To get the retractor into the automatic locking mode, pull the shoulder belt portion of the seat belt until the entire length of the belt is out of the retractor.

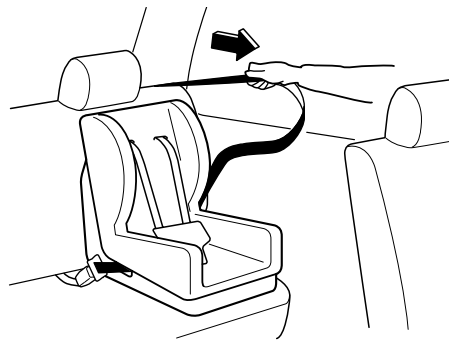

Essential Safety Equipment  
**Child Restraint**

4. Push the child-restraint system firmly into the vehicle seat. Be sure the belt retracts as snugly as possible. Clicking from the retractor will be heard during retraction if the system is in the automatic locking mode. If the belt does not lock the seat down tight, repeat this step.

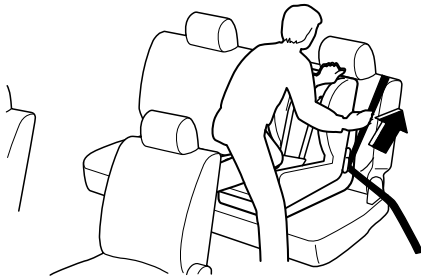

**NOTE**

*Inspect this function before each use of the child-restraint system. You should not be able to pull the shoulder belt out of the retractor while the system is in the automatic locking mode. When you remove the child-restraint system, be sure the belt fully retracts to return the system to emergency locking mode before occupants use the seat belts.*

5. If your child-restraint system requires the use of a tether strap, refer to the manufacturer's instructions to hook and tighten the tether strap after raising the head restraint.

**Anchor bracket location**

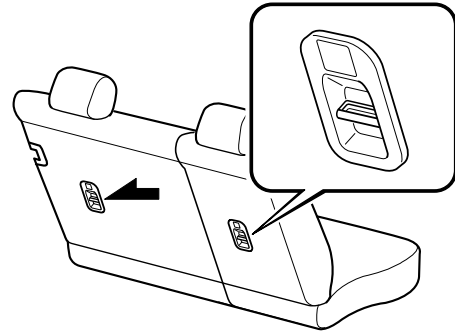

**Tether strap position**

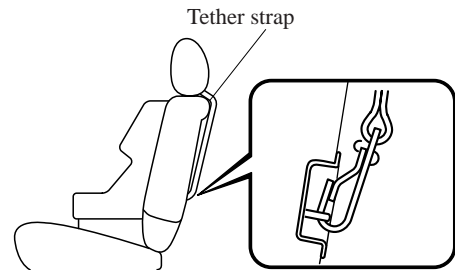

Essential Safety Equipment

## Child Restraint

### **WARNING**

**Use the tether and tether anchor only for a child-restraint system:**

*Using the tether or tether anchor to secure anything but a child-restraint system is dangerous. This could weaken or damage the tether or tether anchor and result in injury.*

**Always route the tether strap between the head restraint and the seatback:**

*Routing the tether strap on top of the head restraint is dangerous. In a collision the tether strap could slide off the head restraint and loosen the child-restraint system. The child-restraint system could move which may result in death or injury to the child.*

**Always attach the tether strap to the correct tether anchor position:**

*Attaching the tether strap to the incorrect tether anchor position is dangerous. In a collision, the tether strap could come off and loosen the child-restraint system. If the child-restraint system moves it could result in death or injury to the child.*

### **Center-Rear Seat Child-Restraint System Installation**

Follow these instructions when using a child-restraint system, unless you are attaching a LATCH-equipped child-restraint system to the rear LATCH lower anchors. Refer to “LATCH Child-Restraint Systems” (page 2-41).

### **WARNING**

**Use the tether and tether anchor only for a child-restraint system:**

*Using the tether or tether anchor to secure anything but a child-restraint system is dangerous. This could weaken or damage the tether or tether anchor and result in injury.*

**Always attach the tether strap to the correct tether anchor position:**

*Attaching the tether strap to the incorrect tether anchor position is dangerous. In a collision, the tether strap could come off and loosen the child-restraint system. If the child-restraint system moves it could result in death or injury to the child.*

### **NOTE**

*Follow the child-restraint system manufacturer's instructions carefully. If you are not sure whether you have a LATCH system or tether, check in the child-restraint system manufacturer's instructions and follow them accordingly. Depending on the type of child-restraint system, it may not employ seat belts which are in automatic locking mode.*

1. Make sure the seatback is securely latched by pushing it back until it is fully locked.

Essential Safety Equipment  
**Child Restraint**

2. Secure the child-restraint system with the lap portion of the lap/shoulder belt. See the manufacturer's instructions on the child-restraint system for belt routing instructions.
3. To get the retractor into the automatic locking mode, pull the shoulder belt portion of the seat belt until the entire length of the belt is out of the retractor.

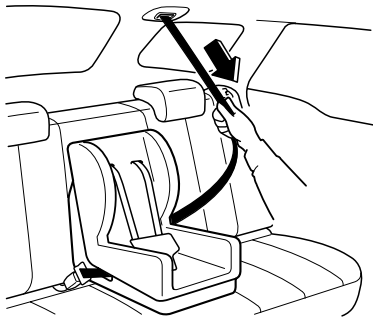

4. Push the child-restraint system firmly into the vehicle seat. Be sure the belt retracts as snugly as possible. Clicking from the retractor will be heard during retraction if the system is in the automatic locking mode. If the belt does not lock the seat down tight, repeat this step.

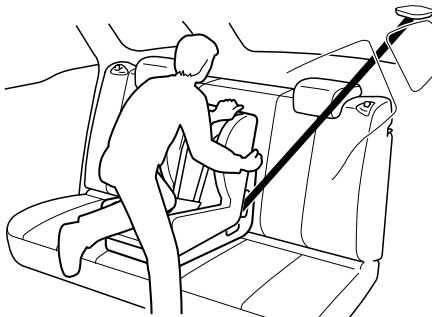

**NOTE**

*Inspect this function before each use of the child-restraint system. You should not be able to pull the shoulder belt out of the retractor while the system is in the automatic locking mode. When you remove the child-restraint system, be sure the belt fully retracts to return the system to emergency locking mode before occupants use the seat belts.*

**Type A**

1. If your child-restraint system requires the use of a tether strap, hook and tighten the tether strap. First, remove the anchor bracket cover on the rear end trim.

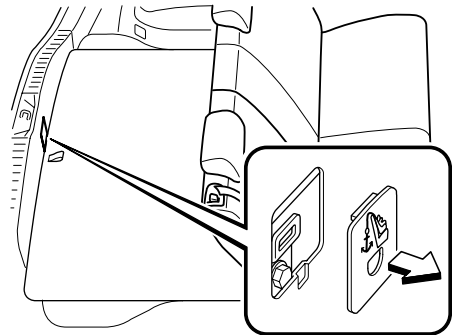

2. Flip over the trunk board.

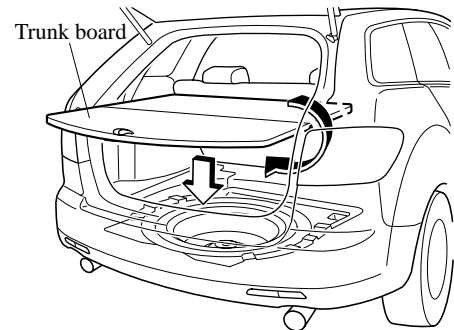

Essential Safety Equipment

## Child Restraint

3. Fold the trunk board into the position shown in the figure.

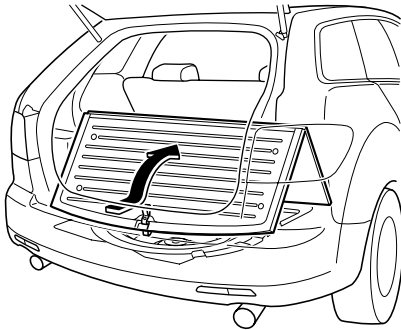

4. Latch the hook onto the anchor bracket, and tighten the tether strap following the child-restraint system manufacturer's instructions.

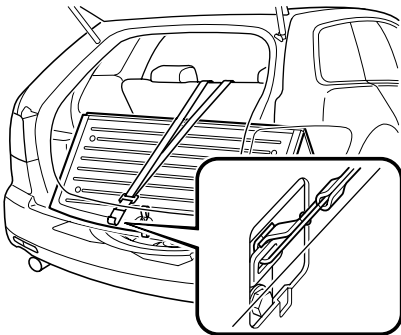

5. Push the trunk board down to its original position.

### **Type B**

1. If your child-restraint system requires the use of a tether strap, hook and tighten the tether strap. First, pull up the front part of the trunk board and remove the anchor bracket cover on the trunk board.

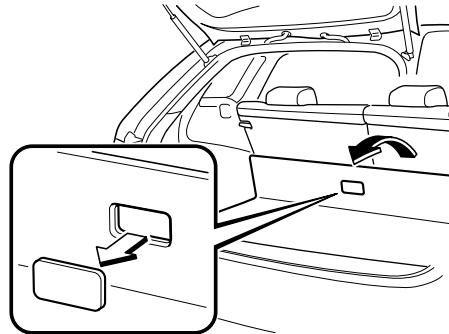

2. Pass the tether strap through the hole.

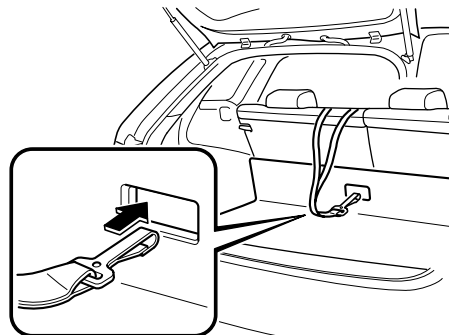



Essential Safety Equipment  
**Child Restraint**

3. Latch the hook onto the anchor bracket.

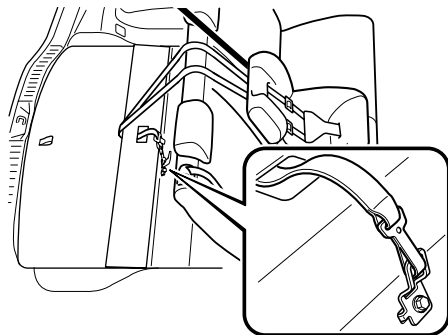

4. Push the trunk board down to its original position, and tighten the tether strap following the child-restraint system manufacturer's instructions.

▼ **If You Must Use the Front Seat for Children**

If you cannot put all children in the rear seat, at least put the smallest children in the rear and be sure the largest child up front uses the shoulder belt over the shoulder.

NEVER put a rear-facing child-restraint system on the front passenger seat, even with a seat weight sensor equipped vehicle.

This seat is also not set up for tethered child-restraint systems, put them in one of the rear seat positions set up with tether anchors.

Likewise the LATCH child-restraint system cannot be secured in the front passenger's seat and should be used in the rear seat.

Don't allow anyone to sleep against the side window if you have an optional side and curtain air bag, it could cause serious injuries to an out of position occupant. As children more often sleep in cars, it is better to put them in the rear seat. If installing the child-restraint system on the front seat is unavoidable, follow these instructions when using a front-facing child-restraint system in the front passenger's seat.

**NOTE**

- To check if your front seats have side air bags:  
Mazda vehicles equipped with side air bag will have a "SRS AIRBAG" tag on the outboard shoulder of the front seats.
- To check if your vehicle has curtain air bags:  
Mazda vehicles equipped with curtain air bag will have an "SRS AIRBAG" marking on the window pillars along the roof edge.

Essential Safety Equipment

## Child Restraint

### **⚠ WARNING**

**Always move the front passenger seat as far back as possible if installing a front-facing child-restraint system on it is unavoidable:**

As your vehicle has front air bags and doubly so if your vehicle has side air bags, a front-facing child-restraint system should be put on the front passenger seat only when it is unavoidable.

Even if the front passenger air bag deactivation indicator light illuminates, always move the seat as far back as possible, because the force of a deploying air bag could cause serious injury or death to the child.

**Never use a rear-facing child-restraint system in the front seat with an air bag that could deploy:**

Rear-facing child-restraint systems on the front seat are particularly dangerous.

Even in a moderate collision, the child-restraint system can be hit by a deploying air bag and moved violently backward resulting in serious injury or death to the child. Even though you may feel assured that the front passenger air bag will not deploy based on the fact that the front passenger air bag deactivation indicator light illuminates.

**Do not allow a child to lean over or against the side window of a vehicle with side and curtain air bags:**

It is dangerous to allow anyone to lean over or against the side window, the area of the front passenger seat, the front and rear window pillars and the roof edge along both sides from which the side and curtain air bags deploy, even if a child-restraint system is used. If the vehicle is equipped with side and curtain air bags, the impact of inflation could cause serious injury or death to the child. Furthermore, leaning over or against the front door could block the side and curtain air bags and eliminate the advantages of supplemental protection. With the front air bag and the additional side air bag that comes out of the front seat, the rear seat is always a better location for children. Do not allow a child to lean over or against the side window, even if the child is seated in a child-restraint system.

### **▼ Front Passenger's Seat Child-Restraint System Installation**

1. Slide the seat as far back as possible.



Essential Safety Equipment  
**Child Restraint**

2. Secure the child-restraint system with the lap portion of the lap/shoulder belt. See the manufacturer's instructions on the child-restraint system for belt routing instructions.
3. To get the retractor into the automatic locking mode, pull the shoulder belt portion of the seat belt until the entire length of the belt is out of the retractor.
4. Push the child-restraint system firmly into the vehicle seat. Be sure the belt retracts as snugly as possible. Clicking from the retractor will be heard during retraction if the system is in automatic locking mode. If the belt does not lock the seat down tight, repeat the previous step and also this one.

**NOTE**

- *Inspect this function before each use of the child-restraint system. You should not be able to pull the shoulder belt out of the retractor while the system is in the automatic locking mode. When you remove the child-restraint system, be sure the belt fully retracts to return the system to emergency locking mode before occupants use the seat belts.*
- *Follow the child-restraint system manufacturer's instructions carefully. Depending on the type of child-restraint system, it may not employ seat belts which are in automatic locking mode.*

5. Make sure the front passenger air bag deactivation indicator light illuminates after installing a child-restraint system on the front passenger seat. Refer to Front passenger air bag deactivation indicator light on page 2-60.



Essential Safety Equipment

## Child Restraint

---

### **WARNING**

***Do not seat a child in a child-restraint system on the front passenger seat if the front passenger air bag deactivation indicator light does not illuminate:***

*While it is always better to install any child-restraint system on the rear seat, it is imperative that a child-restraint system **ONLY** be used on the front passenger seat if the deactivation indicator light illuminates when the child is seated in the child-restraint system (page 2-60). Seating a child in a child-restraint system installed on the front passenger seat with the front passenger air bag deactivation indicator light not illuminated is dangerous. If this indicator light does not illuminate even when the total seated weight is less than approximately 30 kg (66 lb), this means that the front passenger front and side air bags, and seat belt pretensioner are ready for deployment. If an accident were to deploy an air bag, a child in a child-restraint system sitting in the front passenger seat could be seriously injured or killed. If the indicator light does not illuminate after seating a child in a child-restraint system on the front passenger seat, seat a child in a child-restraint system on the rear seat and consult an Authorized Mazda Dealer as soon as possible.*

Essential Safety Equipment  
**Child Restraint**

## LATCH Child-Restraint Systems

Your Mazda is equipped with LATCH lower anchors for attachment of specially designed LATCH child-restraint systems in the rear seat. Both anchors must be used, otherwise the seat will bounce around and put the child in danger. Most LATCH child-restraint systems must also be used in conjunction with a tether to be effective. If they have a tether you must use it to better assure your child's safety.

### **WARNING**

**Follow the manufacturer's instructions for the use of the child-restraint system:**

*An unsecured child-restraint system is dangerous. In a sudden stop or a collision it could move causing serious injury or death to the child or other occupants. Make sure the child-restraint system is properly secured in place according to the child-restraint system manufacturer's instructions.*

**Never attach two child-restraint systems to the same LATCH lower anchor:**

*Attaching two child-restraint systems to the same LATCH lower anchor is dangerous. In a collision, one anchor may not be strong enough to hold two child-restraint system attachments, and it may break, causing serious injury or death. If you use the seat position for another child-restraint system when an outboard LATCH position is occupied, use the center seat belts instead, and the tether if tether-equipped.*

**Make sure the child-restraint system is properly secured:**

*An unsecured child-restraint system is dangerous. In a sudden stop or a collision it could move causing serious injury or death to the child or other occupants. Follow the child-restraint system manufacturer's instructions on belt routing to secure the seat just as you would with a child in it so that nobody is tempted to put a child in an improperly secured seat later on. When not in use, remove it from the vehicle or fasten it with a seat belt, or latch it down to BOTH LATCH lower anchors for LATCH child-restraint systems.*

**Make sure there are no seat belts or foreign objects near or around the LATCH child-restraint system:**

*Not following the child-restraint system manufacturer's instructions when installing the child-restraint system is dangerous. If seat belts or a foreign object prevent the child-restraint system from being securely attached to the LATCH lower anchors and the child-restraint system is installed improperly, the child-restraint system could move in a sudden stop or collision causing serious injury or death to the child or other occupants. When installing the child-restraint system, make sure there are no seat belts or foreign objects near or around the LATCH lower anchors. Always follow the child-restraint system manufacturer's instructions.*

Essential Safety Equipment

## Child Restraint

### ▼ Child-Restraint System Installation Procedure (Rear Outboard Seats)

1. Make sure the seatback is securely latched by pushing it back until it is fully locked.
2. Expand the open seams on the rear of the seat bottom slightly to verify the locations of the LATCH lower anchors.

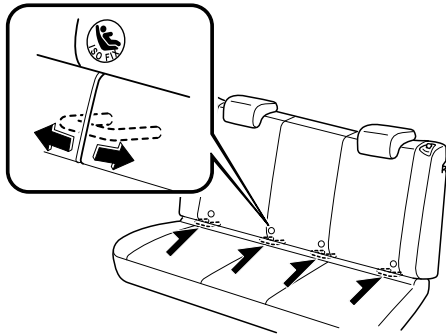

**NOTE**

*The markings above the LATCH lower anchors indicate the locations of LATCH lower anchors for the attachment of a child-restraint system.*

3. Secure the child-restraint system using BOTH LATCH lower anchors, following the child-restraint system manufacturer's instruction.
4. If your child-restraint system came equipped with a tether, that probably means it is very important to properly secure the tether for child safety. Please carefully follow the child-restraint system manufacturer's instructions when installing tethers.

### Anchor bracket location

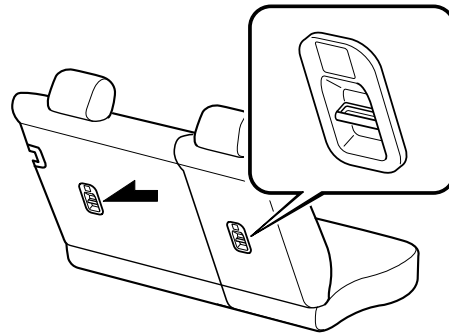

### Tether strap position

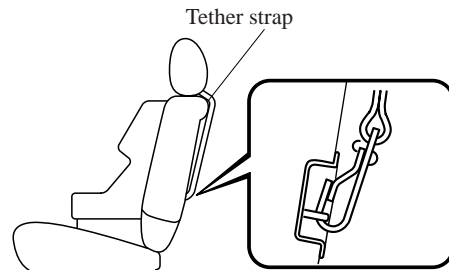

Essential Safety Equipment  
**Child Restraint**

**⚠ WARNING**

**Use the tether and tether anchor only for a child-restraint system:**

*Using the tether or tether anchor to secure anything but a child-restraint system is dangerous. This could weaken or damage the tether or tether anchor and result in injury.*

**Always route the tether strap between the head restraint and the seatback:**

*Routing the tether strap on top of the head restraint is dangerous. In a collision the tether strap could slide off the head restraint and loosen the child-restraint system. The child-restraint system could move which may result in death or injury to the child.*

**Always attach the tether strap to the correct tether anchor position:**

*Attaching the tether strap to the incorrect tether anchor position is dangerous. In a collision, the tether strap could come off and loosen the child-restraint system. If the child-restraint system moves it could result in death or injury to the child.*

**▼ Child-Restraint System Installation Procedure (Center-Rear Seat)**

The LATCH lower anchors at the center of the rear seat are much further apart than the sets of LATCH lower anchors for child-restraint system installation at other seating positions. Child-restraint systems with rigid LATCH attachments cannot be installed on the center seating position. Some LATCH equipped child-restraint systems can be placed in the center position and will reach the nearest LATCH lower anchors which are 400 mm (15.75 in) apart. LATCH compatible child-restraint systems (with attachments on belt webbing) can be used at this seating position only if the child-restraint system manufacturer's instructions state that the child-restraint system can be installed to LATCH lower anchors that are 400 mm (15.75 in) apart. Do not attach two child-restraint systems to the same LATCH lower anchor. If your child-restraint system has a tether, it must also be used for your child's optimum safety.

Essential Safety Equipment

## Child Restraint

### **⚠ WARNING**

**Use the tether and tether anchor only for a child-restraint system:**

*Using the tether or tether anchor to secure anything but a child-restraint system is dangerous. This could weaken or damage the tether or tether anchor and result in injury.*

**Always attach the tether strap to the correct tether anchor position:**

*Attaching the tether strap to the incorrect tether anchor position is dangerous. In a collision, the tether strap could come off and loosen the child-restraint system. If the child-restraint system moves it could result in death or injury to the child.*

1. Make sure the seatback is securely latched by pushing it back until it is fully locked.
2. Expand the open seams on the rear of the seat bottom slightly to verify the locations of the LATCH lower anchors.

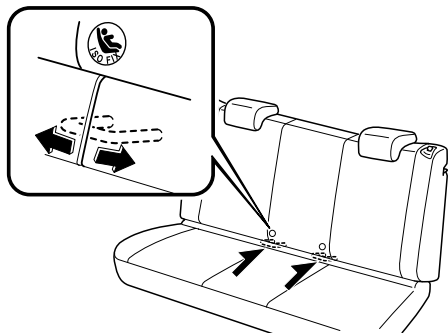

### **NOTE**

*The markings above the LATCH lower anchors indicate the locations of LATCH lower anchors for the attachment of a child-restraint system.*

3. Secure the child-restraint system using BOTH LATCH lower anchors, following the child-restraint system manufacturer's instructions.

### **Type A**

1. If your child-restraint system came equipped with a tether, that probably means it is very important to properly secure the tether for child safety. First, remove the anchor bracket cover on the rear end trim.

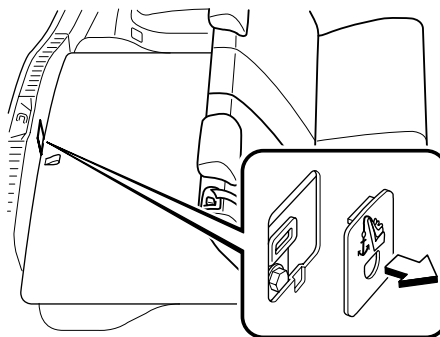

2. Flip over the trunk board.

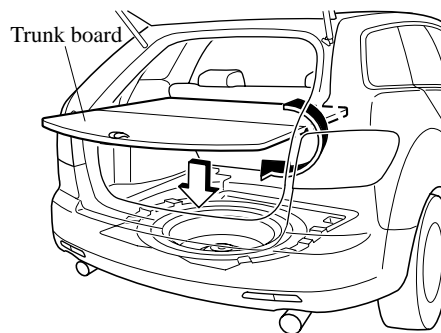



Essential Safety Equipment  
**Child Restraint**

3. Fold the trunk board into the position shown in the figure.

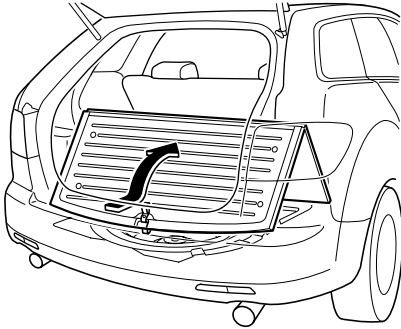

4. Latch the hook onto the anchor bracket, and tighten the tether strap following the child-restraint system manufacturer's instructions.

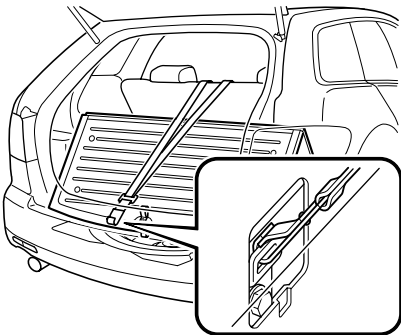

5. Push the trunk board down to its original position.

**Type B**

1. If your child-restraint system requires the use of a tether strap, hook and tighten the tether strap. First, pull up the front part of the trunk board and remove the anchor bracket cover on the trunk board.

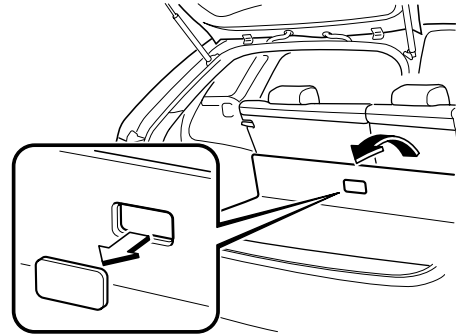

2. Pass the tether strap through the hole.

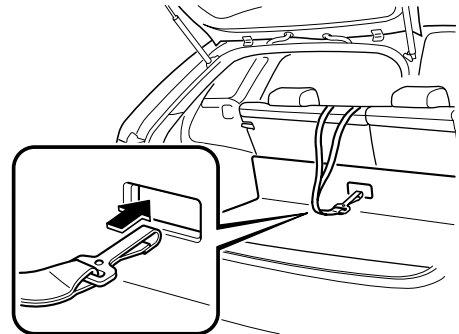

Essential Safety Equipment

## Child Restraint

---

3. Latch the hook onto the anchor bracket.

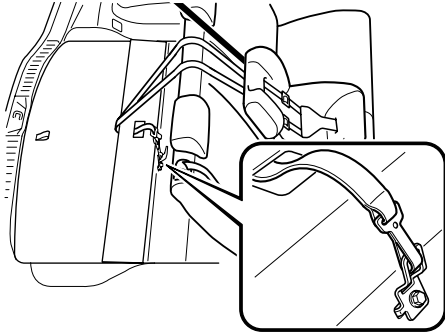

4. Push the trunk board down to its original position, and tighten the tether strap following the child-restraint system manufacturer's instructions.

Essential Safety Equipment  
**SRS Air Bags**

## Supplemental Restraint System (SRS) Precautions

The front and side supplemental restraint systems (SRS) include up to 6 air bags. **Please verify which kinds of air bags are equipped on your vehicle by locating the “SRS AIRBAG” location indicators.** These indicators are visible in the area where the air bags are installed.

The air bags are installed in the following locations:

- The steering wheel hub (driver air bag)
- The front passenger dashboard (front passenger air bag)
- The outboard sides of the front seatbacks (side air bags)
- The front and rear window pillars, and the roof edge along both sides (curtain air bags)

The air bag supplemental restraint systems are designed to provide supplemental protection in certain situations so seat belts are always important in the following ways:

Without seat belt usage, the air bags cannot provide adequate protection during an accident. Seat belt usage is necessary to:

- Keep the occupant from being thrown into an inflating air bag.
- Reduce the possibility of injuries during an accident that is not designed for air bag inflation, such as rear impact.
- Reduce the possibility of injuries in frontal, near frontal, side collisions or roll-over accidents that are not severe enough to activate the air bags.
- Reduce the possibility of being thrown from your vehicle.
- Reduce the possibility of injuries to lower body and legs during an accident because the air bags provide no protection to these parts of the body.
- Hold the driver in a position which allows better control of the vehicle.

**Your vehicle is also equipped with a driver and front passenger occupant classification system. For details, refer to the driver and front passenger occupant classification system (page 2-60).**

Small children must be protected by a child-restraint system as stipulated by law in every state and province. In certain states and provinces, larger children must use a child-restraint system (page 2-28).

Carefully consider which child-restraint system is necessary for your child and follow the installation directions in this Owner's Manual as well as the child-restraint system manufacturer's instructions.

Essential Safety Equipment

## SRS Air Bags

### **⚠ WARNING**

#### **Seat belts must be worn in air bag equipped vehicles:**

*Depending only on the air bags for protection during an accident is dangerous. Alone, air bags may not prevent serious injuries. The appropriate air bags can be expected to inflate only in the first accident, such as frontal, near frontal, side collisions or roll-over accident that are at least moderate. Vehicle occupants should always wear seat belts.*

#### **Children should not ride in the front passenger seat:**

*Placing a child, 12 years or under, in the front seat is dangerous. The child could be hit by a deploying air bag and be seriously injured or even killed. Even if the front passenger air bag deactivation indicator light illuminates, always move the front passenger seat as far back as possible. A sleeping child is more likely to lean against the door and be hit by the side air bag in a moderate, right-side collision. Whenever possible, always secure a child 12 years and under on the rear seats with an appropriate child-restraint system for the child's age and size.*

#### **Never use a rear-facing child-restraint system in the front seat with an air bag that could deploy:**

*Rear-facing child-restraint systems on the front seat are particularly dangerous even though you may feel assured that a front passenger air bag will not deploy based on the fact that the front passenger air bag deactivation indicator light illuminates. The child-restraint system can be hit by a deploying air bag and moved violently backward resulting in serious injury or death to the child.*

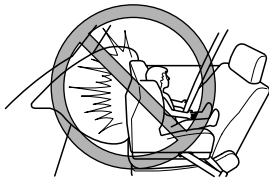

#### **Do not sit too close to the driver and front passenger air bags:**

*Sitting too close to the driver and front passenger air bag modules or placing hands or feet on them is extremely dangerous. The driver and front passenger air bags inflate with great force and speed. Serious injuries could occur if someone is too close. The driver should always hold onto only the rim of the steering wheel. The front seat passenger should keep both feet on the floor. Front seat occupants should adjust their seats as far back as possible and always sit upright against the seatbacks with seat belts worn properly.*

Essential Safety Equipment  
**SRS Air Bags**

**Sit in the center of the seat and wear seat belts properly:**

*Sitting too close to the side air bag modules or placing hands on them and sleeping up against the door or hanging out the windows is extremely dangerous. The side and curtain air bags inflate with great force and speed directly expand along the door on the side the car is hit. Serious injury could occur if someone is sitting too close to the door or leaning against a window, or if rear seat occupants grab the sides of the front seatbacks. Give the side and curtain air bags room to work by sitting in the center of the seat while the vehicle is moving with seat belts worn properly.*

**Do not attach objects on or around the area where driver and front passenger air bags deploy:**

*Attaching an object to the driver and front passenger air bag modules or placing something in front of them is dangerous. In an accident, an object could interfere with air bag inflation and injure the occupants.*

**Do not attach objects on or around the area where a side air bag deploys:**

*Attaching things to the front seat in such a way as to cover the outboard side of the seat in any way is dangerous. In an accident the object could interfere with the side air bag, which inflates from the outboard side of the front seats, impeding the added protection of the side air bag system or redirecting the air bag in a way that is dangerous. Furthermore, the bag could be cut open releasing the gas.*

*Do not hang net bags, map pouches or backpacks with side straps on the front seats. Never use seat covers on the front seats. Always keep the side air bag modules in your front seats free to deploy in the event of a side collision.*

**Do not attach objects on or around the area where a curtain air bag deploys:**

*Attaching objects to the areas where the curtain air bag activates such as on the windshield glass, side door glass, front and rear window pillars and along the roof edge and assist grips is dangerous. In an accident the object could interfere with the curtain air bag, which inflates from the front and rear window pillars and along the roof edge, impeding the added protection of the curtain air bag system or redirecting the air bag in a way that is dangerous. Furthermore, the bag could be cut open releasing the gas.*

*Do not place hangers or any other objects on the assist grips. When hanging clothes, hang them on the coat hook directly. Always keep the curtain air bag modules free to deploy in the event of a side collision or roll-over accident.*

**Do not place luggage or other objects under the front seats:**

*Placing luggage or other objects under the front seats is dangerous. The components essential to the supplemental restraint system could be damaged, and in the event of a side collision, the appropriate air bags may not deploy, which could result in death or serious injury. To prevent damage to the components essential to the supplemental restraint system, do not place luggage or other objects under the front seats.*

Essential Safety Equipment

## SRS Air Bags

---

**Do not touch the components of the supplemental restraint system after the air bags have inflated:**

*Touching the components of the supplemental restraint system after the air bags have inflated is dangerous. Immediately after inflation, they are very hot. You could get burned.*

**Never install any front-end equipment to your vehicle:**

*Installation of front-end equipment, such as frontal protection bar (kangaroo bar, bull bar, push bar, or other similar devices), snowplow, or winches, is dangerous. The air bag crash sensor system could be affected. This could cause air bags to inflate unexpectedly, or it could prevent the air bags from inflating during an accident. Front occupants could be seriously injured.*

**Do not modify the suspension:**

*Modifying the vehicle suspension is dangerous. If the vehicle's height or the suspension is modified, the vehicle will be unable to accurately detect a collision or roll-over accident resulting in incorrect or unexpected air bag deployment and the possibility of serious injuries.*

**Do not use tires or wheels other than those specified for your Mazda:**

*Use of any tire or wheel other than those specified for your Mazda (page 10-6) is dangerous. Use of such wheels will prevent the vehicle's accident detections system from accurately detecting a collision or roll-over accident resulting in incorrect or unexpected air bag deployment and the possibility of serious injuries.*

**Do not overload your vehicle:**

*Overloading your vehicle is dangerous as it could prevent the air bag crash sensor system from accurately detecting a collision or roll-over accident resulting in incorrect or unexpected air bag deployment and the possibility of serious injuries. The gross axle weight rating (GAWR) and the gross vehicle weight rating (GVWR) for your vehicle are on the Motor Vehicle Safety Standard Label on the driver's door frame. Do not exceed these ratings.*

**Do not drive the vehicle off-road:**

*Driving your Mazda off-road is dangerous because the vehicle has not been designed to do such. Driving the vehicle off-road could prevent the air bag crash sensor system from accurately detecting a collision or roll-over accident resulting in incorrect or unexpected air bag deployment and the possibility of serious injuries.*

**Do not modify the supplemental restraint system:**

*Modifying the components or wiring of the supplemental restraint system is dangerous. You could accidentally activate it or make it inoperable. Do not make any modifications to the supplemental restraint system. This includes installing trim, badges, or anything else over the air bag modules. It also includes installing extra electrical equipment on or near system components or wiring. An Authorized Mazda Dealer can provide the special care needed in the removal and installation of front seats. It is important to protect the air bag wiring and connections to assure that the bags do not accidentally deploy, the driver seat slide position sensor and front passenger seat weight sensors are not damaged and that the seats retain an undamaged air bag connection.*

**NOTE**

- *When an air bag deploys, a loud inflation noise can be heard and some smoke will be released. Neither is likely to cause injury, however, the texture of the air bags may cause light skin injuries on body parts not covered with clothing through friction.*
- *Should you sell your Mazda, we urge you to tell the new owner of its air bag systems and that familiarization with all instructions about them, from the Owner's Manual, is important.*

Essential Safety Equipment  
**SRS Air Bags**

**Supplemental Restraint System Components**

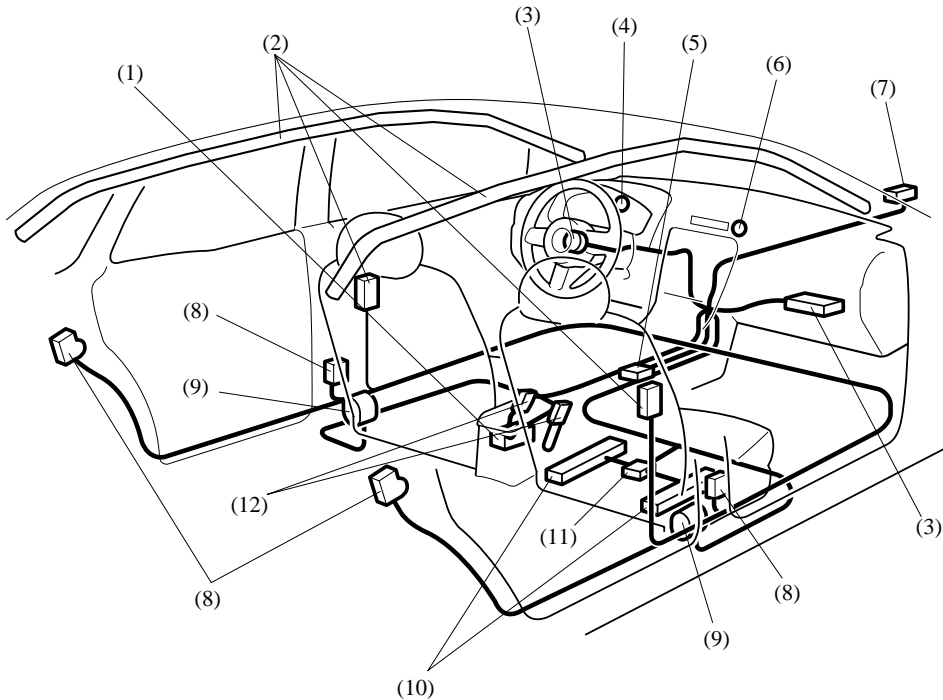

- (1) Driver seat slide position sensor (page 2-60)
- (2) Side and curtain inflators and air bags
- (3) Driver/Front passenger dual stage inflators and air bags
- (4) Air bag/front seat belt pretensioner system warning light (page 2-56)
- (5) Crash and roll-over sensors, and diagnostic module (SAS unit)
- (6) Front passenger air bag deactivation indicator light (page 2-60)
- (7) Front air bag sensor
- (8) Side crash sensor
- (9) Front seat belt pretensioner and load limiting systems (page 2-19)
- (10) Front passenger seat weight sensors (page 2-60)
- (11) Front passenger seat weight sensor control module
- (12) Driver and front passenger seat belt buckle switches (page 2-64)



Essential Safety Equipment  
**SRS Air Bags**

## How the SRS Air Bags Work

Your Mazda is equipped with the following types of SRS air bags. SRS air bags are designed to work together with the seat belts to help to reduce injuries during an accident. The SRS air bags are designed to provide further protection for passengers in addition to the seat belt functions. Be sure to wear seat belts properly.

### ▼ Front Seat Belt Pretensioners

The front seat belt pretensioners are designed to deploy in moderate or severe frontal, near frontal collisions or roll-over accidents.

### ▼ Driver Air Bag

The driver air bag is mounted in the steering wheels.

When air bag crash sensors detect a frontal impact of greater than moderate force, the driver's air bag inflates quickly helping to reduce injury mainly to the driver's head or chest caused by directly hitting the steering wheel.

The driver, dual stage air bag controls air bag inflation in two energy stages. During an impact of moderate severity the driver air bag deploys with lesser energy, whereas during more severe impacts, it deploys with more energy.



Essential Safety Equipment

## SRS Air Bags

---

### ▼ Front Passenger Air Bag

The front passenger air bag is mounted in the front passenger dashboard. The inflation mechanism for the front passenger air bag is the same as the driver's air bag, as mentioned above. In addition, the front passenger air bag is designed to only deploy in accordance with the total seated weight on the front passenger seat. For details, refer to the driver and front passenger occupant classification system (page 2-60).



### ▼ Side Air Bags

The side bags are mounted in the outboard sides of the front seatbacks. When the air bag crash sensors detect a side impact of greater than moderate force, the system inflates the side air bag only on the side in which the vehicle was hit. The side air bag inflates quickly to reduce injury to the driver or front passenger's chest caused by directly hitting interior parts such as a door or window. In addition, the front passenger side air bag is designed to only deploy in accordance with the total seated weight on the front passenger seat. For details, refer to the driver and front passenger occupant classification system (page 2-60).

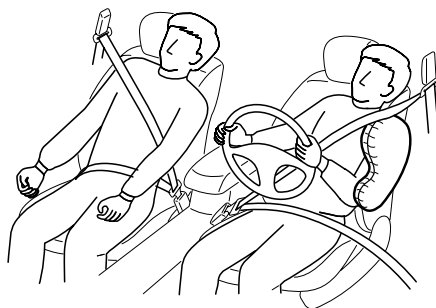

Essential Safety Equipment  
**SRS Air Bags**

▼ **Curtain Air Bags**

The curtain air bags are mounted in the front and rear window pillars, and the roof edge along both sides.

When the air bag crash sensors detect a side impact of greater than moderate force, the curtain air bag inflates quickly and helps to reduce injury mainly to the rear outboard passenger's head caused by directly hitting interior parts such as a door or window.

**In a side impact:**

Greater than moderate impact to one side of the vehicle will cause the curtain air bag on that side only to inflate.



The only one side of curtain air bag will deploy only on the side the vehicle receives the force of the impact.

**In a roll-over:**

In response to a vehicle roll-over, both the curtain air bags inflate.

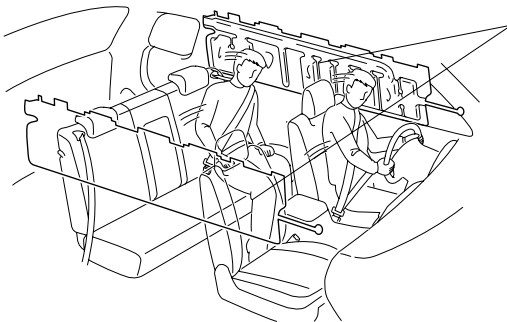

Both curtain air bags will deploy after the roll-over accident is detected.

Essential Safety Equipment  
**SRS Air Bags**

---

▼ **Air Bag/Front Seat Belt Pretensioner System Warning Light**



If the air bag/front seat belt pretensioner system is working properly, the warning light illuminates when the ignition switch is turned to the ON position or after the engine is cranked. The warning light turns off after a specified period of time.

A system malfunction is indicated if the warning light constantly flashes, constantly illuminates or does not illuminate at all when the ignition switch is turned to the ON position. If any of these occur, consult an Authorized Mazda Dealer as soon as possible. The system may not work in an accident.

**⚠ WARNING**

***Never tamper with the air bag/pretensioner systems and always have an Authorized Mazda Dealer perform all servicing and repairs:***

*Self-servicing or tampering with the systems is dangerous. An air bag/pretensioner could accidentally activate or become disabled causing serious injury or death.*

▼ **Air Bag/Front Seat Belt Pretensioner System Warning Beep**

If a malfunction is detected in both the air bag/front seat belt pretensioner system and the warning light, a warning beep sound will be heard for about 1 minute. After that, the one-minute beep will be repeated every 30 minutes.

Have your vehicle inspected at an Authorized Mazda Dealer as soon as possible.

**⚠ WARNING**

***Do not drive the vehicle with the air bag/front seat belt pretensioner system warning beep sounding:***

*Driving the vehicle with the air bag/front seat belt pretensioner system warning beep sounding is dangerous. In a collision, the air bags and the front seat belt pretensioner system will not deploy and this could result in death or serious injury. Contact an Authorized Mazda Dealer to have the vehicle inspected as soon as possible.*

Essential Safety Equipment  
**SRS Air Bags**

**SRS Air Bag Deployment Criteria**

This chart indicates the applicable SRS equipment that will deploy depending on the type of collision.  
 (The illustrations are the representative case of collisions.)

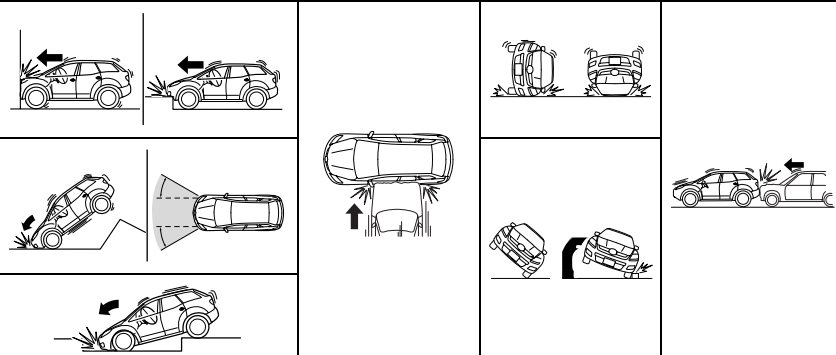
SRS equipment	Types of collision			
	A severe frontal/near frontal collision	A severe side collision	A roll-over/near roll-over	A rear collision
				
Front seat belt pretensioner	X* (both sides)		X* (both sides)	No air bag and front seat belt pretensioner will be activated in a rear collision.
Driver air bag	X			
Front passenger air bag	X*			
Side air bag		X* (impact side only)		
Curtain air bag		X (impact side only)	X (both sides)	

X: The SRS air bag equipment is designed to deploy in a collision.

\*: The front passenger front and side air bags and the seat belt pretensioner are designed to deploy depending on the condition of the total seated weight on the front passenger seat.

Essential Safety Equipment  
**SRS Air Bags**

**Limitations to SRS Air Bag**

In severe collisions or roll-overs such as those described previously in “SRS Air Bag Deployment Criteria”, the applicable SRS air bag equipment will deploy. However, in some accidents, the equipment may not deploy depending on the type of collision and its severity.

**Limitations to front/near front collision detection:**

The following illustrations are examples of front/near front collisions that may not be detected as severe enough to deploy the SRS air bag equipment.

Impacts involving trees or poles

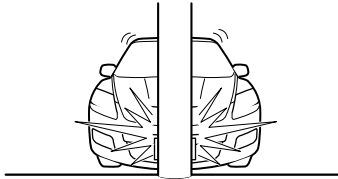

Frontal offset impact to the vehicle

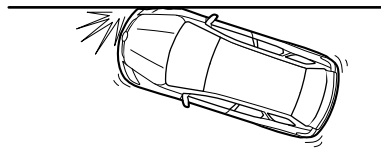

Rear-ending or running under a truck's tail gate

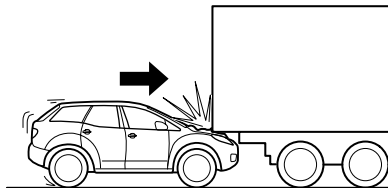

**Limitations to side collision detection:**

The following illustrations are examples of side collisions that may not be detected as severe enough to deploy the SRS air bag equipment.

Side impacts involving trees or poles

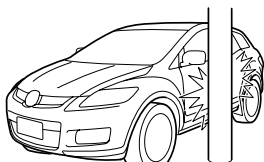

Side impacts with two-wheeled vehicles

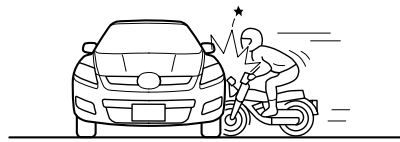

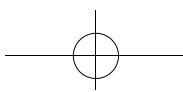

Essential Safety Equipment  
**SRS Air Bags**

---

**Limitations to roll-over detection:**

The following illustrations are examples of accidents that may not be detected as a roll-over accident. Therefore, the front seat belt pretensioners and curtain air bags may not deploy.

Pitch end over end

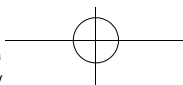
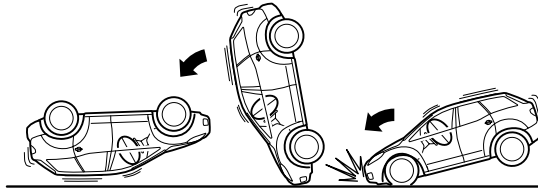

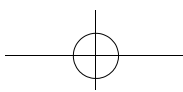

Essential Safety Equipment

## SRS Air Bags

### Driver and Front Passenger Occupant Classification System

First, please read “Supplemental Restraint System (SRS) Precautions” (page 2-47) carefully.

#### ▼ Driver Seat Slide Position Sensor

Your vehicle is equipped with a driver seat slide position sensor as a part of the supplemental restraint system. The sensor is located under the driver seat. The sensor determines whether the driver seat is fore or aft of a reference position and sends the seat position to the diagnostic module (SAS unit). The SAS unit is designed to control the deployment of the driver air bag depending on how close the driver seat is to the steering wheel.

The air bag/front seat belt pretensioner system warning light flashes if the sensor has a possible malfunction (page 2-56)(Air Bag/Front Seat Belt Pretensioner System Warning Light).

#### ▼ Front Passenger Seat Weight Sensors

Your vehicle is equipped with a front passenger seat weight sensors as a part of the supplemental restraint system. These sensors are located under both of the front passenger seat rails. These sensors determine the total seated weight on the front passenger seat. The SAS unit is designed to prevent the front passenger front and side air bags and seat belt pretensioner system from deploying if the total seated weight is less than approximately 30 kg (66 lb).

To reduce the chance of injuries caused by deployment of the front passenger air bag, the system deactivates the front passenger front and side air bags and also the seat belt pretensioner system when:

- There is no passenger in the front passenger seat. (The front passenger air bag deactivation indicator light does not illuminate.)
- The total seated weight on the front passenger seat is less than approximately 30 kg (66 lb). (The front passenger air bag deactivation indicator light illuminates.)

This system shuts off the front passenger front and side air bags and seat belt pretensioner system, so make sure the front passenger air bag deactivation indicator light illuminates according to the following table.

The air bag/front seat belt pretensioner system warning light flashes and the front passenger air bag deactivation indicator light illuminates if the sensors have a possible malfunction. If this happens, the front passenger front and side air bags and seat belt pretensioner system will not deploy.

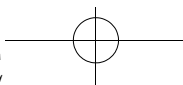



Essential Safety Equipment  
**SRS Air Bags**

**Front passenger air bag deactivation indicator light**

This indicator light illuminates to remind you that the front passenger front and side air bags and seat belt pretensioner will not deploy during a collision.

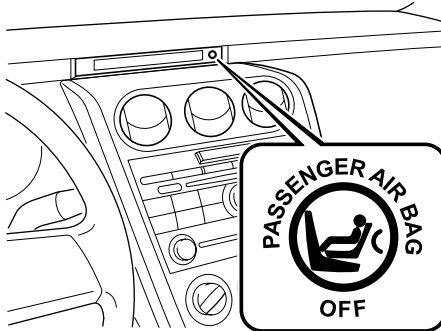

If the front passenger weight sensors are normal, the indicator light illuminates when the ignition switch is turned to the ON position. For a specified of time it goes out.

The front passenger air bag deactivation indicator light illuminates or is off under the following conditions:

Total seated weight on the front passenger seat	Front passenger air bag deactivation indicator light	Front passenger front and side air bags	Front passenger seat belt pretensioner system
Empty (Not occupied)*	OFF	Deactivated	Deactivated
Less than approx. 30 kg (66 lb)	ON	Deactivated	Deactivated
Approx. 42 kg (93 lb) or more	OFF	Ready	Ready

\* If the front passenger seat belt is buckled, the front passenger air bag deactivation indicator light illuminates, however this does not indicate a malfunction. Curtain air bag is ready for inflating despite the chart above.

If the front passenger air bag deactivation indicator light does not illuminate when the ignition switch is turned to the ON position and does not illuminate as indicated in the above chart, do not allow a child to sit in the front passenger seat and consult an Authorized Mazda Dealer as soon as possible. The system may not work properly in an accident.

Essential Safety Equipment  
**SRS Air Bags**

---

**⚠ WARNING**

**Do not decrease the total seated weight on the front passenger seat:**

*When an adult or large child sits on the front passenger seat, decreasing the total seated weight on the front passenger seat from the total seated weight of approximately 42 kg (93 lb) required for air bag deployment is dangerous. The front passenger seat weight sensors will detect the reduced total seated weight condition and the front passenger front and side air bags and seat belt pretensioner system will not deploy during an accident. The front passenger will not have the supplementary protection of the air bag, which could result in serious injury. Decreasing the total seated weight on the front passenger seat from the total seated weight of approximately 42 kg (93 lb) could result in an air bag not deploying under the following conditions, for example:*

- *A rear passenger pushes up on the front passenger seat with the feet.*
- *Luggage or other items placed under the front passenger seat or between the front passenger seat and driver seat that push up the front passenger seat bottom.*
- *The front passenger seat occupant sits in a manner that does not place the entire weight of the occupant on the seat such as by sitting too close to the door, grasping the assist grip or the rim of the moonroof and sitting with the seatback reclined too far.*
- *Any accessories which might decrease the total seated weight on the front passenger seat are attached to the front passenger seat.*

*The front passenger front and side air bags and seat belt pretensioner systems will deactivate if the total seated weight on the front passenger seat is close to 30 kg (66 lb) and they will reactivate before the weight exceeds 42 kg (93 lb).*

Essential Safety Equipment  
**SRS Air Bags**

**Do not increase the total seated weight on the front passenger seat:**

*When an infant or small child sits on the front passenger seat, increasing the total seated weight on the front passenger seat from the total seated weight of approximately 30 kg (66 lb) is dangerous. The front passenger seat weight sensors will detect the increased total seated weight, which could result in the unexpected deployment of the front passenger front and side air bags and seat belt pretensioner system in an accident and may cause serious injury. Increasing the total seated weight on the front passenger seat beyond the total seated weight of approximately 30 kg (66 lb) could result in the front passenger front and side air bags and seat belt pretensioner system deployment in an accident under the following conditions, for example:*

- *Luggage or other items are placed on the seat with the child in the child-restraint system.*
- *A rear passenger or luggage push or pull down on the front passenger seatback.*
- *A rear passenger steps on the front passenger seat rails with the feet.*
- *Luggage or other items are placed on the seatback or hung on the head restraint.*
- *The seat is washed.*
- *Liquids are spilled on the seat.*
- *The front passenger seat is moved backward, pushing into luggage or other items placed behind it.*
- *The front passenger seatback contacts the rear seat.*
- *Luggage or other items are placed between the front passenger seat and driver seat.*
- *Any accessories which might increase the total seated weight on the front passenger seat are attached to the front passenger seat.*

*The front passenger front and side air bags and seat belt pretensioner systems will deactivate if the total seated weight on the front passenger seat is close to 30 kg (66 lb) and they will reactivate before the weight exceeds 42 kg (93 lb).*

**⚠ CAUTION**

- *To assure proper deployment of the front air bag and to prevent damage to the sensors in the front seat bottoms:*
  - *Do not place sharp objects on the front seat bottoms or leave heavy luggage on them.*
  - *Do not spill any liquids on the front seats or under the front seats.*
- *To allow the sensors to function properly, always perform the following:*
  - *Adjust the front seats as far back as possible and always sit upright against the seatbacks with seat belts worn properly.*
  - *If you place your child on the front passenger seat, secure the child-restraint system properly and slide the front passenger seat as far back as possible (page 2-38).*

Essential Safety Equipment

## SRS Air Bags

---

### **NOTE**

- *The system requires about 10 seconds to alternate between turning the front passenger front and side air bags and seat belt pretensioner system on or off.*
- *The front passenger air bag deactivation indicator light may illuminate repeatedly if luggage or other items are put on the front passenger seat, or if the temperature of the vehicle's interior changes suddenly.*
- *The front passenger air bag deactivation indicator light may illuminate for 10 seconds if the total seated weight on the front passenger seat changes.*
- *If the front passenger air bag deactivation indicator light does not illuminate after installing a child-restraint system on the front passenger seat, install the child-restraint system on the rear seat and consult an Authorized Mazda Dealer as soon as possible.*

### **▼ Driver and Front Passenger Buckle Switches**

The buckle switches on the front seat belts detect whether or not the front seat belts are securely fastened and further control the deployment of the air bags.

## Monitoring and Maintenance

### ▼ Constant Monitoring

The following components of the air bag systems are monitored by a diagnostic system:

- SAS unit
- Front air bag sensor
- Air bag modules
- Side crash sensors
- Air bag/Front seat belt pretensioner system warning light
- Front seat belt pretensioners
- Front passenger air bag deactivation indicator light
- Related wiring
- Driver seat slide position sensor
- Front passenger seat weight sensors

The diagnostic module continuously monitors the system's readiness. This begins when the ignition switch is turned to the ON position and continues while the vehicle is being driven.

### ▼ Maintenance

The air bag systems do not require regular maintenance. But if any of the following occurs, take your vehicle to an Authorized Mazda Dealer as soon as possible:

- The air bag system warning light flashes.
- The air bag system warning light remains illuminated.
- The air bag system warning light does not illuminate when the ignition switch is turned to the ON position.
- The air bag system warning beep sound will be heard.
- The air bags have deployed.
- Front passenger air bag deactivation indicator light does not illuminate when the ignition switch is turned to the ON position or does not illuminate as indicated in the chart. For more details about this indicator light and this chart, refer to "Front passenger seat weight sensors" (page 2-60).

Essential Safety Equipment

## SRS Air Bags

---

### **WARNING**

**Do not operate a vehicle with damaged air bag/seat belt pretensioner system components:**

*Expended or damaged air bag/seat belt pretensioner system components must be replaced after any collision which caused them to deploy or damage them. Only a trained Authorized Mazda Dealer can fully evaluate these systems to see that they will work in any subsequent accident. Driving with an expended or damaged air bag or pretensioner unit will not afford you the necessary protection in the event of any subsequent accident which could result in serious injury or death.*

**Do not remove interior air bag parts:**

*Removing any components such as the front seats, front dashboard, the steering wheel or parts on the front and rear window pillars and along the roof edge, containing air bag parts or sensors is dangerous. These parts contain essential air bag components. The air bag could accidentally activate and cause serious injuries. Always have an Authorized Mazda Dealer remove these parts.*

**Dispose of the air bag properly:**

*Improper disposal of an air bag or a vehicle with live air bags in it can be extremely dangerous. Unless all safety procedures are followed, injury can result. Ask an Authorized Mazda Dealer how to safely dispose of an air bag or how to scrap an air bag equipped vehicle.*

### **NOTE**

*If it becomes necessary to have the components or wiring system for the supplementary restraint system modified to accommodate a person with certain medical conditions in accordance with a certified physician, contact an Authorized Mazda Dealer; refer to "Customer Assistance (U.S.A.)" (page 9-2).*

# 3 Knowing Your Mazda

Explanation of basic operations and controls; opening/closing and adjustment of various parts.

<b>Advanced Keyless Entry and Start System .....</b>	<b>3-2</b>
Advanced Keys * .....	3-2
Operation Using Advanced Keyless Functions .....	3-7
Operation Using Advanced Key Functions .....	3-13
Advanced Key Suspend Function .....	3-15
Warning and Beep Sounds .....	3-16
Setting Change (Function Customization) .....	3-18
When Warning Indicator/Beep is Activated .....	3-19
<b>Doors and Locks .....</b>	<b>3-20</b>
Keys (with Retractable Type Key) .....	3-20
Keyless Entry System .....	3-21
Door Locks .....	3-24
Liftgate .....	3-28
Power Windows .....	3-31
Fuel-Filler Lid and Cap .....	3-38
Hood .....	3-39
Moonroof* .....	3-40
<b>Security System .....</b>	<b>3-46</b>
Immobilizer System (with Advanced Key) .....	3-46
Immobilizer System (without Advanced Key) .....	3-48
Theft-Deterrent System * .....	3-51
<b>Steering Wheel and Mirrors .....</b>	<b>3-54</b>
Steering Wheel .....	3-54
Mirrors .....	3-54

\*Some models. **3-1**

Knowing Your Mazda

## Advanced Keyless Entry and Start System

### Advanced Keys \*

The advanced keyless functions (advanced keyless entry and start system) enables the following operations while the advanced key is being carried (page 3-7).

- Locking/unlocking the doors and the liftgate without operating the key.
- Starting the engine without operating the key.

The advanced key enables additional functions other than those with the advanced keyless functions (page 3-13).

- The following operations are possible using the transmitter of the keyless entry system from a distance (Lock/Unlock/Panic button):
  - Locking/unlocking the doors and the liftgate.
  - Opening the power windows and the moonroof.
  - Turning on the alarm.
- Locking/unlocking the doors or starting the engine using the auxiliary key.

#### WARNING

***Do not leave the keys in your vehicle with children and keep them in a place where your children will not find or play with them:***

*Leaving children in a vehicle with the key is dangerous. This could result in someone being badly injured or even killed. These new kinds of keys are fascinating to children. They could play with power windows or other controls, or even make the vehicle move.*

***Radio waves from the advanced key may affect medical equipment such as pacemakers:***

*Before using the advanced key near people who use medical equipment, ask the medical equipment manufacturer or your physician if radio waves from the advanced key will affect the equipment.*

#### **NOTE**

- *The driver must carry the advanced key to ensure the system functions properly.*
- *Refer to Immobilizer System (page 3-46) for information regarding keys and engine starting.*
- ***(With theft-deterrent system)***  
*Refer to Theft-Deterrent System (page 3-51) for information regarding keys and the prevention of vehicle and vehicle contents theft.*



## Advanced Keyless Entry and Start System

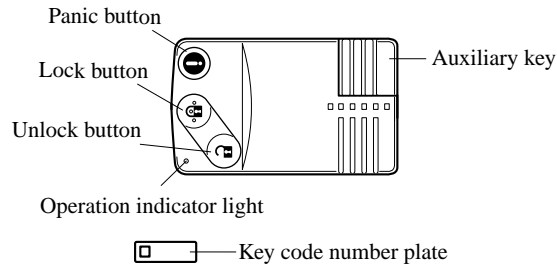

A code number is stamped on the plate attached to the key set; detach this plate and store it in a safe place (not in the vehicle) for use if you need to make a replacement key.

Also write down the code number and keep it in another safe and handy place, but not in the vehicle.

If your key is lost, consult your Authorized Mazda Dealer with the code number ready.

### **CAUTION**

- Because the advanced key uses low-intensity radio waves, it may not function correctly under the following conditions:
  - The advanced key is carried with communication devices such as cellular phones.
  - The advanced key contacts or is covered by a metal object.
  - The advanced key is near electronic devices such as personal computers.
  - Non-Mazda genuine electronic equipment is installed in the vehicle.
  - There is equipment which discharges radio waves near the vehicle.
  - If the vehicle is near equipment such as wireless pay devices installed at certain gas stations.
- The advanced key may consume battery power excessively if it receives high-intensity radio waves. Do not place the advanced key near electronic devices such as televisions or personal computers.
- To avoid damage to the advanced key, DO NOT:
  - Drop the advanced key.
  - Get the advanced key wet.
  - Disassemble the advanced key.
  - Expose the advanced key to high temperatures on places such as the dashboard or hood, under direct sunlight.
  - Place heavy objects on the advanced key.
  - Put the advanced key in an ultrasonic cleaner.
  - Put any magnetized objects close to the advanced key.

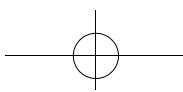

Knowing Your Mazda

## Advanced Keyless Entry and Start System

---

### **NOTE**

- *Battery life is about one year. Replace the battery when the KEY indicator light (green) flashes in the instrument cluster.  
Refer to Advanced Key Battery Dead Warning on page 3-17.*
- *Additional advanced keys can be obtained at an Authorized Mazda Dealer. Up to 6 advanced keys can be used with the advanced keyless functions per vehicle.*

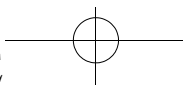

## Advanced Keyless Entry and Start System

### ▼ Advanced Key Maintenance

#### **⚠ CAUTION**

- *Make sure the battery is installed with the correct pole facing upward. Battery leakage could occur if it is not installed correctly.*
- *When replacing the battery, be careful not to bend the electrical terminals or get oil on them. Also be careful not to get dirt in the transmitter as it could be damaged.*
- *There is the danger of explosion if the battery is not correctly replaced.*
- *Replace only with the same type battery (CR2025 or equivalent).*
- *Dispose of used batteries according to the following instructions.*
  - *Insulate the plus and minus terminals of the battery using cellophane or equivalent tape.*
  - *Never disassemble.*
  - *Never throw the battery into fire or water.*
  - *Never deform or crush.*

The following conditions indicate that the battery power is low:

- The KEY indicator light (green) flashes in the instrument cluster when the engine is turned off.
- The system does not operate and the operation indicator light on the transmitter does not flash when the buttons are pressed.
- The system's operational range is reduced.

Replacing the battery at an Authorized Mazda Dealer is recommended to prevent damage to the advanced key. If replacing the battery by yourself, follow the instruction below.

#### **Replacing the advanced key battery**

1. Pull out the auxiliary key.

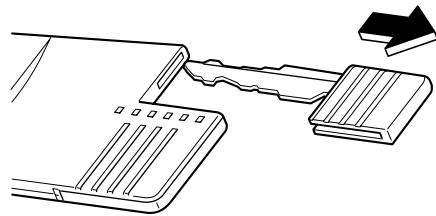

2. Release the cap using a flathead screwdriver, then rotate and remove the cap.

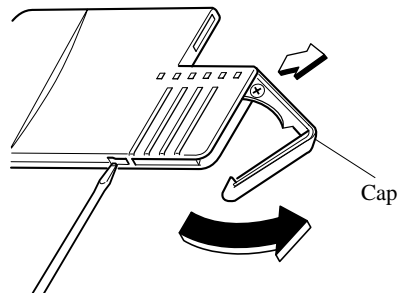

#### **⚠ CAUTION**

*Do not turn the cap excessively. The cap may be damaged.*

Knowing Your Mazda

## Advanced Keyless Entry and Start System

3. Insert a flathead screwdriver into the crack and press the battery out.

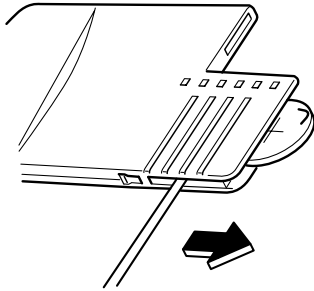

4. Insert the new battery (CR2025 or equivalent) with the positive pole (+) facing the (+) mark on the cap.

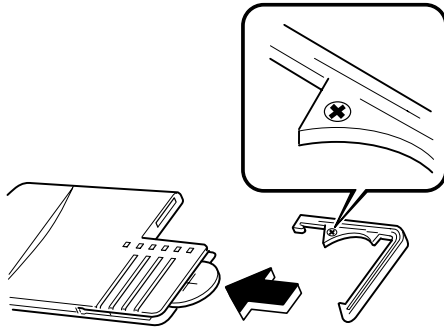

5. Rotate and close the cap.

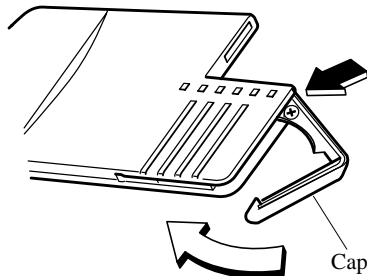

6. Reinsert the auxiliary key.

3-6

### ▼ Service

If you have a problem with the advanced keyless functions, consult an Authorized Mazda Dealer.

If your advanced key is lost or stolen, bring all remaining advanced keys to an Authorized Mazda Dealer as soon as possible for a replacement and to make the lost or stolen advanced key inoperative.

### ⚠ CAUTION

*Radio equipment like this is governed by laws in the United States. Changes or modifications not expressly approved by the party responsible for compliance could void the user's authority to operate the equipment.*

## Advanced Keyless Entry and Start System

### Operation Using Advanced Keyless Functions

#### ▼ Operational Range

The system operates only when the driver is in the vehicle or within operational range while the advanced key is being carried.

#### **NOTE**

*When the battery power is low, or in places where there are high-intensity radio waves or noise, the operational range may become narrower or the system may not operate.*

#### **Locking, unlocking the doors and the liftgate**

The operational range for locking/unlocking the doors is an area of up to 80 cm (2.6 ft) from the center of the front door handles.

The operational range for locking/unlocking the liftgate is an area of up to 80 cm (2.6 ft) from the center of the liftgate.

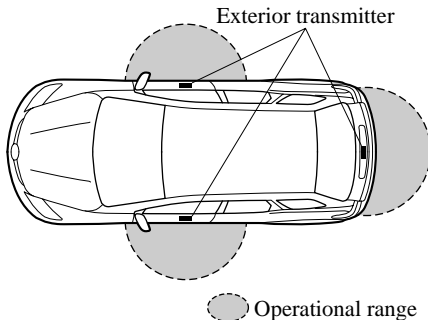

#### **NOTE**

*The system may not operate if you are too close to the windows, door handles, or liftgate.*

#### **Starting the engine**

The operational range for starting the engine includes nearly the entire cabin area except for the luggage compartment.

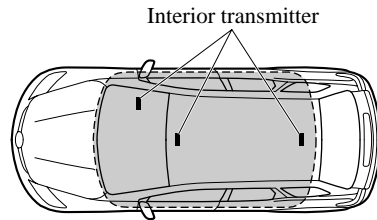

Operational range

#### **NOTE**

- *The luggage compartment is out of the operational range, however, starting the engine may be possible.*
- *The engine may not start if the advanced key is placed in the following areas:*
  - *Around the dashboard*
  - *In the storage compartments such as the glove box*
- *Starting the engine may be possible even if the advanced key is outside of the vehicle and extremely close to a door and window, however, always start the engine from the driver's seat.*

*If the vehicle is started and the advanced key is not in the vehicle, the vehicle will not restart after it is shut off and the ignition switch is turned to the lock position.*
- *If the advanced key is detected within operational range, the operation indicator light located in the instrument cluster flashes momentarily.*

Knowing Your Mazda

## Advanced Keyless Entry and Start System

### ▼ Locking, Unlocking with Request Switch

All doors and the liftgate can be locked/unlocked by pressing the request switch on the front doors or the liftgate while the advanced key is being carried.

#### Front doors

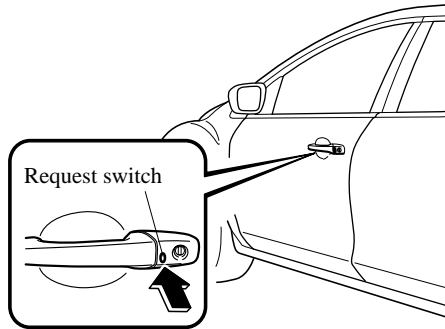

#### Liftgate

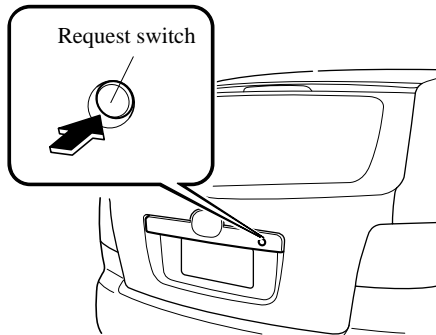

#### To lock

To lock the doors and the liftgate, press the request switch. A beep sound will be heard once and the hazard warning lights will flash once.

#### **NOTE**

##### ***(Without theft-deterrent system)***

*The hazard warning lights will flash once to indicate that the doors and the liftgate are locked.*

##### ***(With theft-deterrent system)***

- *The hazard warning lights will not flash.*
- *The hazard warning lights only flash when the theft deterrent system is armed or turned off; refer to the theft-deterrent system (page 3-51).*

#### To unlock

##### **Driver's door request switch**

To unlock the driver's door, press the request switch. A beep sound will be heard twice and the hazard warning lights will flash twice.

To unlock all doors and the liftgate, press the request switch again within 3 seconds and two more beep sounds will be heard.

#### **NOTE**

##### ***(Without theft-deterrent system)***

*The hazard warning lights will flash twice to indicate that the doors and the liftgate are unlocked.*

##### ***(With theft-deterrent system)***

- *The hazard warning lights will not flash.*
- *The hazard warning lights only flash when the theft deterrent system is armed or turned off; refer to the theft-deterrent system (page 3-51).*

##### **Front passenger door/liftgate request switch**

To unlock the doors and the liftgate, press the request switch. A beep sound will be heard twice and the hazard warning lights will flash twice.

## Advanced Keyless Entry and Start System

### NOTE

- The request switch on the driver's door can be used to close the power windows and the moonroof.

Refer to the following pages:

Opening/Closing the Power Windows (page 3-35)

Opening/Closing the Moonroof (page 3-42)

- Confirm that all doors and the liftgate are securely locked.
- All doors and the liftgate cannot be locked when any door or the liftgate is open.
- A beep sound is heard for confirmation when the doors and the liftgate are locked/unlocked using the request switch. If you prefer, the beep sound can be turned off (page 3-18).
- The setting can be changed so that the doors and the liftgate are locked automatically without pressing the request switch (page 3-18).

### (Auto-lock function)

A beep sound is heard when all doors and the liftgate are closed while the advanced key is being carried. All doors and the liftgate are locked automatically after about 3 seconds when the advanced key is out of the operational range. Also, the hazard warning lights flash once. (Even if the driver is in the operational range, all doors and the liftgate are locked automatically after about 30 seconds.)

If you are out of the operational range before the doors and the liftgate are completely closed or another advanced key is left in the vehicle, the auto-lock function will not work. Always make sure that all doors and the liftgate are closed and locked before leaving the vehicle.

- **(Auto re-lock function)**

After unlocking doors and the liftgate by pressing the request switch, all doors and the liftgate will automatically lock and the hazard warning light will flash if any of the following operations are not performed within about 30 seconds.

- A door or the liftgate is opened.
- The auxiliary key is inserted into the ignition switch.
- The start knob is pushed.

### ▼ Starting the Engine

#### Ignition switch positions

Without a traditional key, some of the ignition switch functions are different.

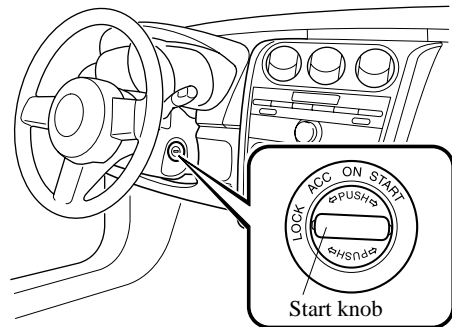

#### **LOCK (Released)**

The steering wheel locks to help protect against theft.

#### **LOCK (Depressed)**

The ignition switch can be turned to the ACC position when the KEY indicator light (green) illuminates in the instrument cluster.

Knowing Your Mazda

## Advanced Keyless Entry and Start System

### **⚠ WARNING**

**Before leaving the driver's seat, always put the key or start knob to LOCK position, set the parking brake and make sure the shift lever is in P:**

*Intentionally placing the key or start knob into LOCK position is much more important where you will not be removing the key to leave the vehicle and because leaving it in other positions will disable some of the vehicle security systems and run the battery down.*

*Leaving the driver's seat without putting the ignition switch in LOCK position, setting the parking brake and the shift lever is in P is dangerous. Unexpected vehicle movement could occur. This could cause an accident.*

### **NOTE**

- *If turning the ignition switch is difficult, jiggle the steering wheel from side to side.*
- *The ignition switch cannot be turned from the ACC position to the LOCK position when the shift lever is not in P.*

### **ACC (Accessory)**

The steering wheel unlocks and some electrical accessories will operate.

### **NOTE**

*The Advanced Keyless Entry System does not function in the ACC position, and the doors will not lock/unlock using the transmitter or request switches even if the advanced key is carried away from the vehicle.*

### **ON**

This is the normal running position after the engine is started. The warning lights (except brakes) should be inspected before the engine is started (page 5-38).

### **3-10**

### **NOTE**

*When the ignition switch is turned to the ON position, the sound of the fuel pump motor operating near the fuel tank can be heard. This does not indicate an abnormality.*

### **START**

The engine is started in this position. It will crank until you release the start knob; then it returns to the ON position. The brake warning light can be checked after the engine is started (page 5-38).

### **Starting the engine**

### **NOTE**

- *Engine-starting is controlled by the spark ignition system.*  
*This system meets all Canadian Interference-Causing Equipment Standard requirements regulating the impulse electrical field strength of radio noise.*
- *The advanced key must be carried because the advanced key carries an immobilizer chip that must communicate with the engine controls at short range.*
- *When starting the engine, be sure the start knob is securely attached before trying to operate it. If the knob becomes detached from the ignition switch, re-attach it by pushing it on to the ignition switch.*

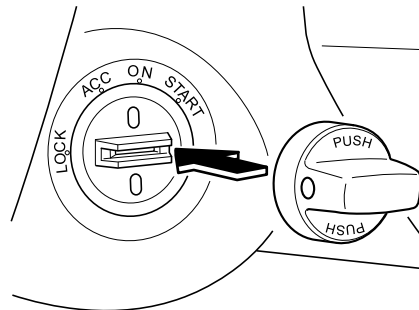



## Advanced Keyless Entry and Start System

1. Make sure the advanced key is being carried.
2. Occupants should fasten their seat belts.
3. Make sure the parking brake is on.
4. Depress the brake pedal.
5. Put the vehicle in park (P). If you must restart the engine while the vehicle is moving, shift into neutral (N).

### NOTE

The starter will not operate if the shift lever is not in P or N.

6. Push the start knob slowly all the way in.

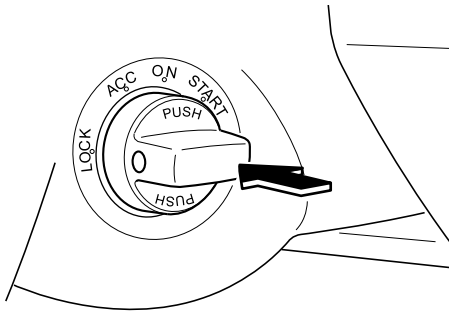

7. Verify that the KEY indicator light (green) illuminates in the instrument cluster. The KEY warning light (red) means you cannot continue to start the engine using the Advanced Keyless System. You may have to use the auxiliary key instead (page 3-19).

# KEY

### NOTE

In the following cases, the KEY warning light (red) illuminates and the engine will not start.

- The advanced key battery is dead.
- The advanced key is out of operational range.
- The advanced key is placed in areas where it is difficult for the system to detect the signal (page 3-7).
- A key from another manufacturer similar to the advanced key is in the operational range.

8. Turn the ignition switch to the ACC position while pushing the start knob in.

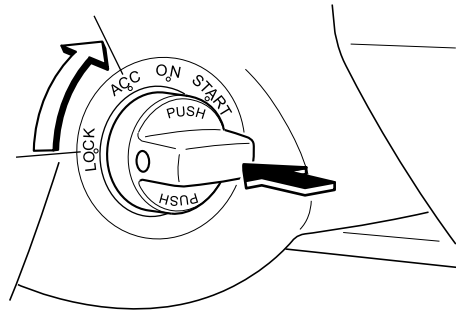

9. Turn the ignition switch from the ACC position to the START position and hold (up to 10 seconds at a time) until the engine starts.

### CAUTION

Don't try the starter for more than 10 seconds at a time. If the engine stalls or fails to start, wait 10 seconds before trying again. Otherwise, you may damage the starter and drain the battery.

10. After starting the engine, let it idle for about 10 seconds.

Knowing Your Mazda

## Advanced Keyless Entry and Start System

### NOTE

- *In extremely cold weather or after the vehicle has not been driven in several days, let the engine warm up without operating the accelerator.*
- *Whether the engine is cold or warm, it should be started without use of the accelerator.*

### Turning off the engine

1. Move the shift lever to the P position.
2. Turn the ignition switch from the ON position to the ACC position.

### NOTE

*When the engine is turned off and the ignition switch is turned from the ACC position to the LOCK position, the KEY indicator light (green) flashes in the instrument cluster for about 30 seconds if the battery power of the advanced key is low. Replace the battery with a new one.*

*Refer to Battery Replacement (page 3-6).*

3. Push in the start knob from the ACC position and turn it to the LOCK position.

### CAUTION

*When leaving the vehicle, make sure the ignition switch is turned to the LOCK position.*

### NOTE

- *When turning the ignition switch to the LOCK position, the ignition switch has to be pushed in from the ACC position and turned. Without being pushed in, the ignition switch stops at the ACC position and the vehicle battery may be discharged if the ignition switch is left in the ACC position. When leaving the vehicle, make sure the ignition switch is turned to the LOCK position.*
- *If the vehicle is left with the ignition switch not in the LOCK position, a beep sound is heard and the indicator light flashes to notify the driver.*  
*Refer to Warning Beep (page 3-16).*

## Advanced Keyless Entry and Start System

### Operation Using Advanced Key Functions

#### ▼ Keyless Entry System

This system uses the more traditional key buttons to remotely lock and unlock the doors and the liftgate, and opens the power windows, and opens the power windows and the moonroof.

It can also help you signal for attention. Press the buttons slowly and carefully.

#### NOTE

- The keyless entry system is designed to operate up to about 2.5 m (8 ft) from the center of the vehicle, but this may vary due to local conditions.
- The system does not operate when the ignition switch is not in the LOCK position or the start knob is pushed in.
- With the start knob installed in the LOCK position, the system is fully operational. If the ignition switch is not in the LOCK position or the start knob is pushed in, the system does not operate.
- All doors and the liftgate cannot be locked by pressing the lock button while any door or the liftgate is open. The hazard warning lights will also not flash.
- If the transmitter does not operate when pressing a button or the operational range becomes too small, the battery may be dead. To install a new battery, refer to Maintenance (page 3-5).

#### Transmitter

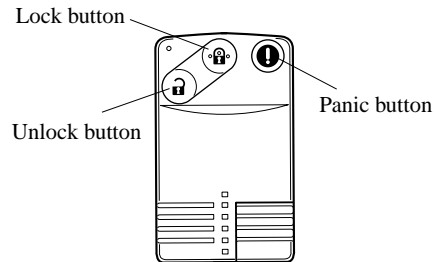

#### NOTE

- **(U.S.A.)**  
This device complies with Part 15 of the FCC Rules. Operation is subject to the following two conditions: (1) this device may not cause harmful interference, and (2) this device must accept any interference received, including interference that may cause undesired operation.
- **(CANADA)**  
This device complies with RSS-210 of Industry CANADA. Operation is subject to the following two conditions: (1) this device may not cause interference, and (2) this device must accept any interference, including interference that may cause undesired operation of the device.

#### NOTE

The unlock button can be used to open the power windows and the moonroof, but the lock button cannot be used to close the power windows and the moonroof.

Refer to the following pages:

Opening/Closing the Power Windows (page 3-35)

Opening/Closing the Moonroof (page 3-42)

The operation indicator light flashes when the buttons are pressed.

Knowing Your Mazda

## Advanced Keyless Entry and Start System

### Lock button

To lock the doors and the liftgate, press the lock button. A beep sound will be heard once and the hazard warning lights will flash once.

To confirm that all doors and the liftgate have been locked, press the lock button again within 5 seconds. If they are closed and locked, the horn will sound.

#### **NOTE**

##### **(Without theft-deterrent system)**

The hazard warning lights will flash once to indicate that all doors and the liftgate are locked.

##### **(With theft-deterrent system)**

- The hazard warning lights will not flash.
- The hazard warning lights only flash when the theft deterrent system is armed or turned off, refer to the theft-deterrent system (page 3-51).

#### **NOTE**

- All doors and the liftgate cannot be locked when any door or the liftgate is open.
- Confirm that all doors and the liftgate are locked visually or audibly by use of the double click.

### Unlock button

To unlock the driver's door, press the unlock button. A beep will be heard twice and the hazard warning lights will flash twice.

To unlock all doors and the liftgate, press the unlock button again within 3 seconds and two more beep sounds will be heard.

#### **NOTE**

##### **(Without theft-deterrent system)**

The hazard warning lights will flash twice to indicate that all doors and the liftgate are unlocked.

##### **(With theft-deterrent system)**

- The hazard warning lights will not flash.
- The hazard warning lights only flash when the theft deterrent system is armed or turned off, refer to the theft-deterrent system (page 3-51).

#### **NOTE**

##### **Auto re-lock function**

After unlocking with the transmitter, all doors and the liftgate will automatically lock if one of the doors or the liftgate is not opened within about 30 seconds.

### Panic button

If you witness from a distance someone attempting to break into or damage your vehicle, pressing the panic button will activate the vehicle's alarm.

#### **NOTE**

The panic button will work whether any door or the liftgate is open or closed.

#### **(Turning on the alarm)**

Pressing the panic button for 1 second or more will trigger the alarm for about 2 minutes and 30 seconds, and the following will occur:

- The horn sounds intermittently.
- The hazard warning lights flash.

#### **NOTE**

However, if the driver is too close to the vehicle the panic button may not function.

#### **(Turning off the alarm)**

The alarm stops by pressing any button on the transmitter.

## Advanced Keyless Entry and Start System

### ▼ Auxiliary Key Function

Use the auxiliary key stored in the advanced key in the event of a dead transmitter battery or malfunction.

#### Removing the auxiliary key

Pull out the auxiliary key from the advanced key.

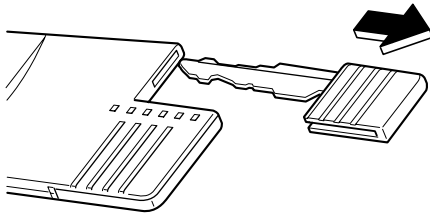

#### Locking, unlocking the doors

The doors can be locked/unlocked using the auxiliary key, refer to Locking, Unlocking with Key (page 3-25).

#### Starting the engine

The engine can be started with the auxiliary key, refer to Ignition Switch (page 5-2).

### Advanced Key Suspend Function

If one advanced key is left in the vehicle and a second advanced key is used to lock it, the functions of the advanced key left in the vehicle is temporarily suspended to prevent theft of the vehicle.

The following are inoperable:

- Starting the engine using the start knob.
- Operating the request switches.

To restore these functions, perform any one of the following:

- Press the lock or unlock button on the advanced key which has had its functions temporarily suspended.
- While carrying another advanced key, push in the start knob until the KEY indicator light (green) illuminates.
- Insert the auxiliary key and turn the ignition switch to the ON position.

Knowing Your Mazda

## Advanced Keyless Entry and Start System

### Warning and Beep Sounds

#### ▼ System Malfunction Warning Beep

If any malfunction occurs in the advanced keyless function, the KEY warning light (red) in the instrument cluster illuminates continuously and beep sounds will be heard.

#### CAUTION

*If the KEY warning light (red) remains illuminated, do not continue to drive the vehicle with the advanced keyless function. Park the vehicle in a safe place and use the auxiliary key to continue driving the vehicle. Have the vehicle inspected at an Authorized Mazda Dealer as soon as possible. Refer to Ignition Switch (page 5-2).*

#### ▼ Start Knob Not in LOCK Warning Beep

If the start knob is in the ACC position and the driver's door is opened, a continuous beep sound will be heard to notify the driver that the start knob has not been returned to the LOCK position. In this case, the keyless entry system does not operate, the car cannot be locked, and the battery will run down.

#### ▼ Advanced Key Removed from Vehicle Warning Beep

Under the following conditions, a beep sound will be heard 6 times and the KEY warning light (red) will flash continuously when the start knob has not been returned to the LOCK position to notify the driver that the advanced key has been removed. The KEY warning light (red) will stop flashing when the advanced key is back inside the vehicle:

- The start knob has not been returned to the LOCK position, the driver's door is open, and the advanced key is removed from the vehicle.  
However the beep sound will be heard continuously when the start knob is in the ACC position and the door is open due to the activation of the warning beep sound indicating that the start knob is not in the LOCK position.
- The start knob has not been returned to the LOCK position and all the doors are closed after removing the advanced key from the vehicle.

#### **NOTE**

*Because the advanced key utilizes low-intensity radio waves, the Advanced Key Removed From Vehicle Warning may activate if the advanced key is carried together with a metal object or it is placed in a poor signal reception area.*

#### ▼ Request Switch Inoperable Warning Beep

Under the following conditions, if the request switch for a front door or the liftgate is pressed while the advanced key is being carried, a beep will be heard 6 times to indicate that the front doors and the liftgate cannot be locked.

- A door or the liftgate is open (door ajar included).

## Advanced Keyless Entry and Start System

- The start knob has not been returned to the LOCK position.
- The auxiliary key is inserted into the ignition switch.

### ▼ Advanced Key Battery Dead Warning

When the start knob is returned to the ACC or LOCK position from the ON position, the KEY indicator light (green) flashes for approximately 30 seconds indicating that the remaining battery power is low. Replace with a new battery before the advanced key becomes unusable.

Refer to Advanced Key Maintenance (page 3-5).

#### **NOTE**

*The advanced key can be set so that the KEY indicator light (green) does not flash even if the battery power is low.*

*Refer to Setting Change (page 3-18).*

### ▼ Engine Start Not Permitted Warning

Under the following conditions, the KEY warning light (red) flashes to inform the driver that the start knob will not rotate to the ACC position even if it is pushed in from the LOCK position.

- The advanced key battery is dead.
- The advanced key is not within operational range.
- The advanced key is placed in areas where it is difficult for the system to detect the signal (page 3-7).
- A key from another manufacturer similar to the advanced key is in the operational range.

### ▼ Advanced Key Left-in-vehicle Warning Beep

If an advanced key is left in the vehicle cabin and all the doors and the liftgate are locked using a separate advanced key, a beep sound is heard for about 10 seconds to remind the driver that the advanced key has been left in the vehicle cabin. If this happens, the doors and the liftgate lock but the functions of the advanced key left in the vehicle cabin may be temporarily suspended. Perform the following procedure to restore the functions of the advanced key (page 3-15).

Knowing Your Mazda

## Advanced Keyless Entry and Start System

### Setting Change (Function Customization)

The following function settings are possible. These settings can only be changed by an Authorized Mazda Dealer.

Setting	Function	At Initial Setting	After Setting Change
Advanced key battery dead indicator	KEY indicator light (green) flashes to indicate that the advanced key battery power is low.	Activated	Deactivated
Lock/unlock operation confirmation beep sound*1	A beep sound is heard to confirm that all doors or the liftgate have been locked/unlocked.	Activated	Deactivated
Autolock function *2	When all doors and the liftgate are closed and the advanced key is being carried and out of operational range, all the doors and the liftgate automatically lock after 3 seconds. (Even if the driver is in the operational range, all doors and the liftgate are locked automatically after about 30 seconds.)	Deactivated	Activated

\*1: When the autolock function is operating, the warning sound will be heard regardless of the setting.

\*2: When Autolock function is enabled, windows will not automatically close. You must close before leaving vehicle.



## Advanced Keyless Entry and Start System

### When Warning Indicator/Beep is Activated

Under the following conditions, warning beeps are heard and a warning/indicator light in the instrument cluster illuminates to notify the driver of improper operation of the advanced key to prevent theft of the vehicle (page 3-16).

Warning	What to check
When a door is open, a continuous beep sound will be heard.	Check whether the start knob has been returned to the LOCK position.
When a door is open, 6 beep sounds are heard, and the KEY warning light (red) in the instrument cluster flashes.	Check whether the advanced key has been removed from the vehicle.
When a door is closed, a beep sound is heard 6 times, and the KEY warning light (red) in the instrument cluster flashes.	Check whether the advanced key has been removed from the vehicle.
When attempting to lock the doors, a beep sound is heard.	Check whether the advanced key has been left in the vehicle.
	Check whether the start knob has been returned to the LOCK position.
	Check whether a door or the liftgate is open.
When the KEY indicator light (green) flashes in the instrument cluster.	The advanced key battery power is low. Replace the battery with a new one. Refer to Advanced Key Maintenance on page 3-5.
When the KEY warning light (red) remains illuminated in the instrument cluster.	The advanced key is malfunctioning. Park the vehicle in a safe place, and use the auxiliary key to continue driving the vehicle. Have the vehicle inspected at an Authorized Mazda Dealer as soon as possible.

Knowing Your Mazda

## Doors and Locks

### Keys (with Retractable Type Key)

#### **⚠ WARNING**

**Do not leave the keys in your vehicle with children and keep them in a place where your children will not find or play with them:**

*Leaving children in a vehicle with the key is dangerous. This could result in someone being badly injured or even killed. These new kinds of keys are fascinating to children. They could play with power windows or other controls, or even make the vehicle move.*

#### **NOTE**

- Refer to *Immobilizer System* (page 3-48) for information regarding keys and engine starting.
- **(With theft-deterrent system)**  
Refer to *Theft-Deterrent System* (page 3-51) for information regarding keys and the prevention of vehicle and vehicle contents theft.

The keys operate all locks.

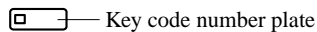
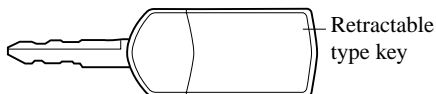

A code number is stamped on the plate attached to the key set; detach this plate and store it in a safe place (not in the vehicle) for use if you need to make a replacement key.

#### **NOTE**

*Write down the code number and keep it in a separate safe and convenient place, but not in the vehicle.*

*If your key is lost, consult your Authorized Mazda Dealer and have your code number ready.*

#### **Key extend/retract method (Retractable type key)**

To extend the key, press the release button.

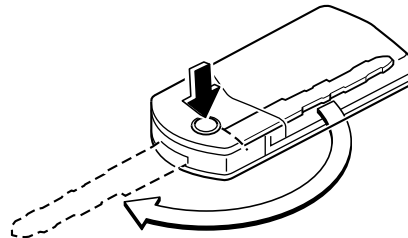

To retract the key, rotate it into the holder while pressing the release button.

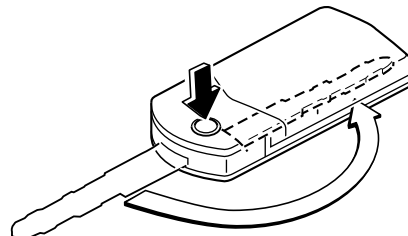

Knowing Your Mazda  
**Doors and Locks**

## Keyless Entry System

This system remotely locks and unlocks the doors and the liftgate, and opens the power windows and the moonroof. It can also help you signal for attention. Press the buttons slowly and carefully.

### **CAUTION**

To avoid damage to the transmitter, do not:

- Drop the transmitter.
- Get the transmitter wet.
- Disassemble the transmitter.
- Expose the transmitter to any kind of magnetic field.
- Expose the transmitter to high temperatures on places such as the dashboard or hood, under direct sunlight.

### **NOTE**

- The keyless entry system is designed to operate up to about 2.5 m (8 ft) from the center of the vehicle, but this may vary due to local conditions.
- The system doesn't operate when the key is in the ignition switch.
- Doors and the liftgate cannot be locked by pressing the lock button while any other door or the liftgate is open. Also, the hazard warning lights will not flash.
- If the transmitter does not operate when pressing a button or the operation range becomes too small, the battery may be dead. To install a new battery, refer to Maintenance (page 3-23).
- Additional transmitters can be obtained at an Authorized Mazda Dealer. Up to 3 transmitters can be used with the keyless entry system per vehicle. Bring all transmitters to an Authorized Mazda Dealer when additional transmitters are required.

### ▼ Transmitter

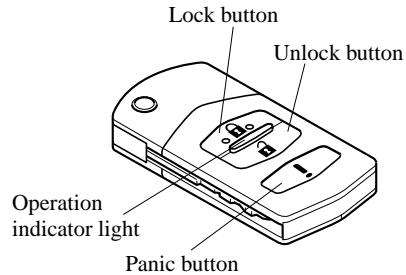

### **NOTE**

- **(U.S.A.)**  
This device complies with Part 15 of the FCC Rules. Operation is subject to the following two conditions: (1) this device may not cause harmful interference, and (2) this device must accept any interference received, including interference that may cause undesired operation.
- **(CANADA)**  
This device complies with RSS-210 of Industry CANADA. Operation is subject to the following two conditions: (1) this device may not cause interference, and (2) this device must accept any interference, including interference that may cause undesired operation of the device.

### **NOTE**

The unlock button can be used to open the power windows and the moonroof, but the lock button cannot be used to close the power windows and the moonroof.

Refer to the following pages:

Opening/Closing the Power Windows (page 3-35)

Opening/Closing the Moonroof (page 3-42)

The operation indicator light flashes when the buttons are pressed.

Knowing Your Mazda

## Doors and Locks

### Lock button

To lock the doors and the liftgate, press the lock button and the hazard warning lights will flash once.

To confirm that all doors and the liftgate have been locked, press the lock button again within 5 seconds. If they are closed and locked, the horn will sound.

#### **NOTE**

- **(Without theft-deterrent system)**  
*The hazard warning lights will flash once to indicate that all doors and the liftgate are locked.*
- **(With theft-deterrent system)**
  - *The hazard warning lights will not flash.*
  - *The hazard warning lights only flash when the theft deterrent system is armed or turned off; refer to the theft-deterrent system (page 3-51).*

#### **NOTE**

- *All doors and the liftgate cannot be locked when any door or the liftgate is open and the key is in the ignition switch.*
- *Confirm that all doors and the liftgate are locked visually or audibly by use of the double click.*

### Unlock button

To unlock the driver's door, press the unlock button and the hazard warning lights will flash twice.

To unlock all doors and the liftgate, press the unlock button again within 3 seconds.

#### **NOTE**

##### **(Without theft-deterrent system)**

*The hazard warning lights will flash twice to indicate that all doors and the liftgate are unlocked.*

##### **(With theft-deterrent system)**

- *The hazard warning lights will not flash.*
- *The hazard warning lights only flash when the theft deterrent system is armed or turned off; refer to the theft-deterrent system (page 3-51).*

#### **NOTE**

##### **Auto re-lock function**

*After unlocking with the transmitter, all doors and the liftgate will automatically lock if one of the doors or the liftgate is not opened within about 30 seconds.*

### Panic button

If you witness from a distance someone attempting to break into or damage your vehicle, pressing the panic button will activate the vehicle's alarm.

#### **NOTE**

*The panic button will work whether any door or the liftgate is open or closed.*

### **Turning on the alarm**

Pressing the panic button for 1 second or more will trigger the alarm for about 2 minutes and 30 seconds, and the following will occur:

- The horn sounds intermittently.
- The hazard warning lights flash.

### **Turning off the alarm**

Press any button on the transmitter.

## Knowing Your Mazda Doors and Locks

### ▼ Transmitter Maintenance

If the buttons on the transmitter are inoperable and the operation indicator light does not flash, the battery may be dead.

Replace with a new battery before the transmitter becomes unusable.

#### **CAUTION**

- Install the battery with the positive pole (+) facing down. Battery leakage could occur if it is not installed correctly.
- When replacing the battery, be careful not to bend the electrical terminals or get oil on them. Also be careful not to get dirt in the transmitter as it could be damaged.
- There is the danger of explosion if the battery is not correctly replaced.
- Replace only with the same type battery (CR1620 or equivalent).
- Dispose of used batteries according to the following instructions.
  - Insulate the plus and minus terminals of the battery using cellophane or equivalent tape.
  - Never disassemble.
  - Never throw the battery into fire and/or water.
  - Never deform or crush.

#### **Replacing the transmitter battery**

1. Unfold the key (page 3-20).

2. Insert a screwdriver into the slot and push the tab to remove the key from the transmitter.

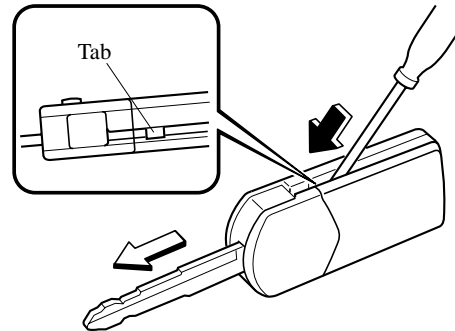

3. Insert a screwdriver into the slot and gently pry open the transmitter.

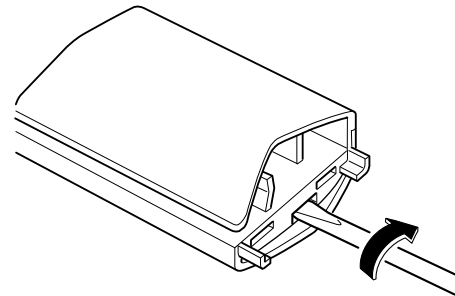

4. Remove the battery.

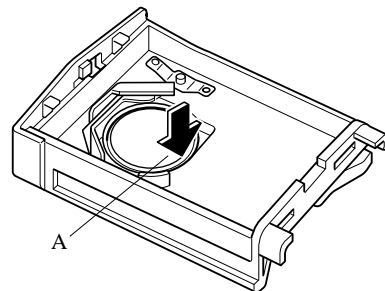

Knowing Your Mazda

## Doors and Locks

- Put in the new battery (CR1620 or equivalent) with the positive pole (+) facing down.

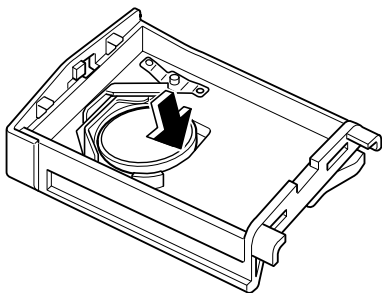

- Align the front and back covers and snap the transmitter shut.
- Install the key to the transmitter.

### ▼ Service

If you have a problem with the keyless entry system, consult an Authorized Mazda Dealer.

If your transmitter is lost or stolen, bring all remaining transmitters to an Authorized Mazda Dealer as soon as possible for a replacement and to make the lost or stolen transmitter inoperative.

### ⚠ CAUTION

*Radio equipment like this is governed by laws in the United States. Changes or modifications not expressly approved by the party responsible for compliance could void the user's authority to operate the equipment.*

## Door Locks

### ⚠ WARNING

**Always take all children and pets with you or leave a responsible person with them:**

*Leaving a child or a pet unattended in a parked vehicle is dangerous. In hot weather, temperatures inside a vehicle can become high enough to cause brain damage or even death.*

**Do not leave the keys in your vehicle with children and keep them in a place where your children will not find or play with them:**

*Leaving children in a vehicle with the key is dangerous. This could result in someone being badly injured or even killed. They could play with power windows or other controls, or even make the vehicle move.*

**Keep all doors locked when driving:**

*Unlocked doors in a moving vehicle are dangerous. Passengers can fall out if a door is accidentally opened and can more easily be thrown out in an accident.*

**Always close all the windows, lock the doors and take the key with you when leaving your vehicle unattended:**

*Leaving your vehicle unlocked is dangerous as children could lock themselves in a hot vehicle, which could result in death. Also, a vehicle left unlocked becomes an easy target for thieves and intruders.*

## Knowing Your Mazda Doors and Locks

### ▼ Locking, Unlocking with Key

The driver's door can be locked/unlocked with the key.  
Turn the key toward the front to unlock, toward the back to lock.

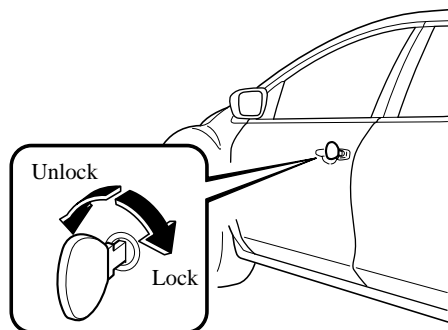

### ▼ Locking, Unlocking with Request Switch (with Advanced Key)

The doors can be locked/unlocked by operating the request switch while carrying the advanced key outside the vehicle, refer to Operations Using Advanced Keyless Functions (page 3-7).

### ▼ Locking, Unlocking with Transmitter (with Advanced Key)

The doors can be locked/unlocked by operating the keyless entry system transmitter, refer to Keyless Entry System (page 3-13).

### ▼ Locking, Unlocking with Transmitter (with Retractable Type Key)

The doors can be locked/unlocked by operating the keyless entry system transmitter, refer to Keyless Entry System (page 3-21).

### ▼ Locking, Unlocking with Door-Lock Knob

To lock any door from the inside, push the door-lock knob.  
To unlock, pull it out.  
This does not operate the other door locks.

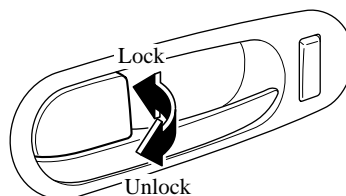

To lock any door with the door-lock knob from the outside, push the door-lock knob to the lock position and close the door.  
This does not operate the other door locks.

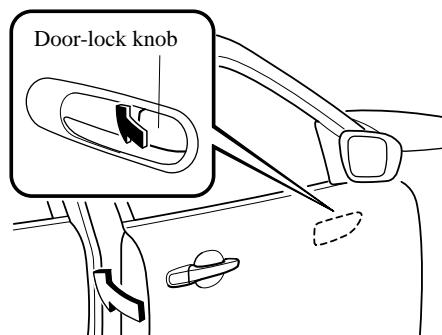

Knowing Your Mazda

## Doors and Locks

### **NOTE**

- **(With advanced key)**  
*The driver's door cannot be locked using the door-lock knob from the outside.*
- **(With retractable type key)**  
*The driver's door cannot be locked using the door-lock knob from the outside if the key is in the ignition switch.*
- *When locking the doors this way, be careful not to leave the key inside the vehicle.*

### ▼ Power Door Locks

#### **Vehicle lock-out prevention**

##### **(With advanced key)**

The vehicle lock-out prevention feature prevents you from locking yourself out of the vehicle. All doors and the liftgate will automatically unlock if they are locked using the power door locks with any door or the liftgate open.

##### **(With retractable type key)**

The vehicle lock-out prevention feature prevents you from locking yourself out of the vehicle. With the key in the ignition switch, all doors and the liftgate will automatically unlock if they are locked using the power door locks with any door or the liftgate open.

### **Locking, unlocking with key**

All doors and the liftgate lock automatically when the driver's door is locked with the key. All doors and the liftgate unlock when the driver's door is unlocked and the key is held in the unlock position for one second or longer.

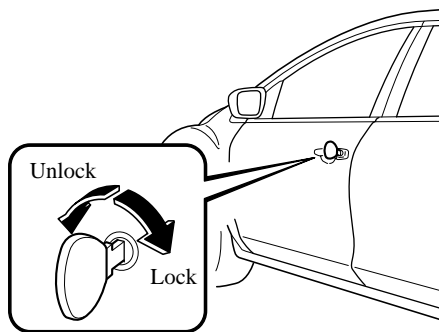

### **NOTE**

*Holding the key in the unlocked position in the driver's door lock for about a second unlocks all doors and the liftgate. To unlock only the driver's door, insert the key into the driver's door lock and turn the key briefly to the unlock position and then immediately return it to the center position.*



Knowing Your Mazda  
**Doors and Locks**

**Locking, unlocking with door-lock switch**

All doors and the liftgate lock automatically when lock side is pushed. They all unlock when unlock side is pushed.

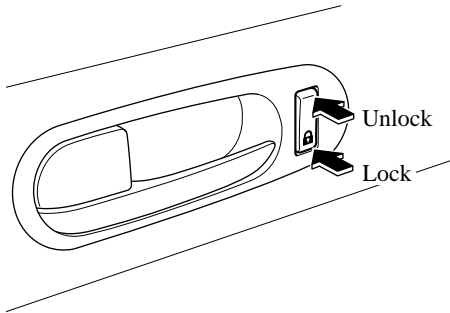

**Locking, unlocking with request switch (with advanced key)**

All doors and the liftgate can be locked/unlocked by operating the request switch on the front doors and the liftgate while carrying the advanced key outside the vehicle, refer to Operations Using Advanced Keyless Functions (page 3-7).

**Locking, unlocking with transmitter (with advanced key)**

All doors and the liftgate can be locked/unlocked by operating the keyless entry system transmitter, refer to Keyless Entry System (page 3-13).

**Locking, unlocking with transmitter (with retractable type key)**

All doors and the liftgate can be locked/unlocked by operating the keyless entry system transmitter, refer to Keyless Entry System (page 3-21).

**▼ Rear Door Child Safety Locks**

These locks are intended to help prevent children from accidentally opening the rear doors. Use them both whenever a child rides in the vehicle.

If you slide the child safety lock to the lock position before closing that door, the door cannot be opened from the inside. The door can be opened only by pulling the outside handle.

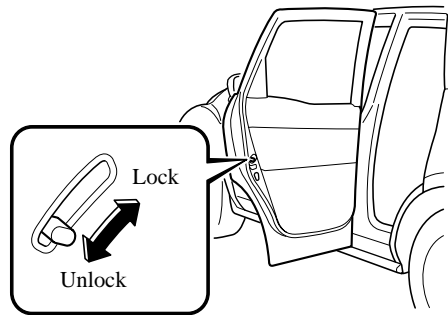

Knowing Your Mazda

## Doors and Locks

### Liftgate

#### **⚠ WARNING**

**Never allow a person to ride in the luggage compartment:**

*Allowing a person to ride in the luggage compartment is dangerous. The person in the luggage compartment could be seriously injured or killed during sudden braking or a collision.*

**Do not drive with the liftgate open:**

*Exhaust gas in the cabin of a vehicle is dangerous. An open liftgate in a moving vehicle will cause exhaust gas to be drawn into the cabin. This gas contains CO (carbon monoxide), which is colorless, odorless, and highly poisonous, and it can cause loss of consciousness and death. Moreover, an open liftgate could cause occupants to fall out in an accident.*

#### ▼ Locking, Unlocking with Key

The liftgate can be locked/unlocked by inserting the key into the driver's door key slot, refer to Power Door Locks (page 3-26).

#### ▼ Locking, Unlocking with Request Switch (with Advanced Key)

The liftgate can be locked/unlocked by operating the request switch while carrying the advanced key outside the vehicle, refer to Operations Using Advanced Keyless Functions (page 3-7).

#### ▼ Locking, Unlocking with Transmitter (with Advanced Key)

The liftgate can be locked/unlocked by operating the keyless entry system transmitter, refer to Keyless Entry System (page 3-13).

#### ▼ Locking, Unlocking with Transmitter (with Retractable Type Key)

The liftgate can be locked/unlocked by operating the keyless entry system transmitter, refer to Keyless Entry System (page 3-21).

#### ▼ Locking, Unlocking with Door-Lock Switch

The liftgate can be locked/unlocked by operating the door-lock switch, refer to Power Door Locks (page 3-26).

#### ▼ Opening and Closing the Liftgate

##### Opening the liftgate

Pull up on the handle.

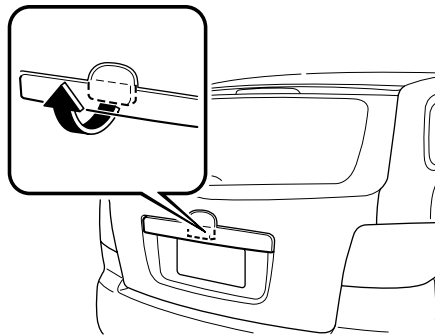

Knowing Your Mazda  
**Doors and Locks**

**NOTE**

If the vehicle battery is dead or there is a malfunction in the electrical system and the liftgate cannot be unlocked, perform the following procedure as an emergency measure to unlock it:

1. Remove the cap on the interior surface of the liftgate with a flathead screwdriver.

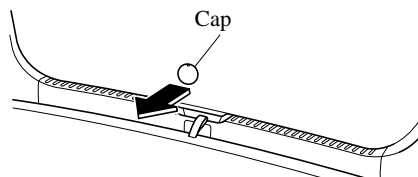
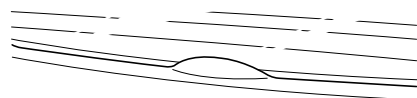

2. Turn the lever to the right to unlock the liftgate.

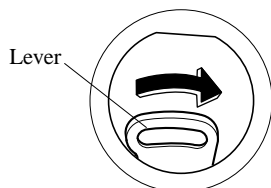

After performing this emergency measure, have the vehicle inspected at an Authorized Mazda Dealer as soon as possible.

**Closing the liftgate**

Use both hands to push the liftgate down until the lock snaps shut. Do not slam it. Pull up on the liftgate to make sure it is securely latched.

▼ **Luggage Compartment**

**⚠ WARNING**

**Do not place luggage or other cargo on top of the luggage compartment cover:**

Placing luggage or other cargo on top of the luggage compartment cover is dangerous. During sudden braking or a collision, the cargo could become a projectile that could hit and injure someone. The vehicle has a light weight luggage compartment cover to keep the contents of your luggage area out of sight; it will not retain heavy objects that are not tied down in an accident such as a rollover. Tie down all heavy objects, whether luggage or cargo, using the tie down hooks.

**Make sure luggage and cargo is secured before driving:**

Not securing cargo while driving is dangerous as it could move or be crushed during sudden braking or a collision and cause injury.

**⚠ CAUTION**

Make sure the luggage compartment cover is firmly secured. If it is not firmly secured, it could unexpectedly disengage resulting in injury.

Knowing Your Mazda

## Doors and Locks

### Luggage compartment cover \*

#### Installing the cover

1. Insert the left end of the retractor bar into the notch.

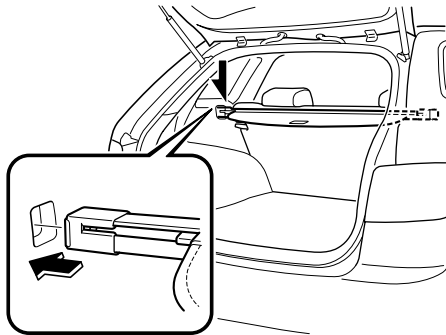

2. Squeeze the spring holder on right end of the retractor bar inward, then insert it into the notch.

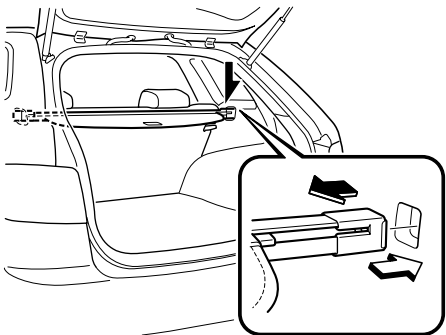

3. Slowly pull out the cover and insert it into the retainers.

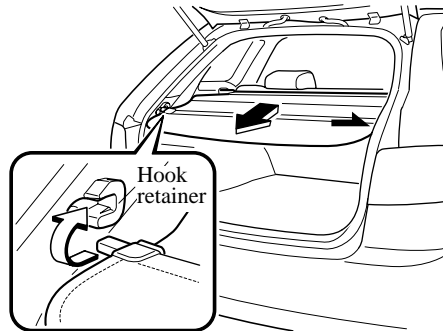

#### Removing the cover

Reverse the procedure for installation.

## Knowing Your Mazda Doors and Locks

### Power Windows

The ignition switch must be in the ON position for the power windows to operate.

#### **⚠ WARNING**

**Make sure the opening is clear before closing a window:**

*Closing power windows are dangerous. A person's hands, head, or even neck could be caught by the window and result in serious injury or even death.*

*This warning applies especially to children.*

**Always lock all passenger power windows with the power window lock switch on the driver's side while children are in the vehicle, and never allow children to play with power window switches:**

*Leaving the power window switches unlocked while children are in the vehicle is dangerous. Power window switches that are not locked with the power window lock switch would allow children to operate power windows unintentionally which could result in serious injury if a child's hands, head or neck becomes caught by the window.*

#### **⚠ CAUTION**

*To prevent burning out the fuse and damaging the power window system, do not open or close more than three windows at once.*

### ▼ Operating the Front Power Windows

#### **NOTE**

- *Each passenger power window can be operated with each door switch when the power window lock switch on the driver's door is in the unlocked position (page 3-35).*
- *Each passenger power window can also be operated by the power window master control switches on the driver's door.*

#### **Owner master control switch**

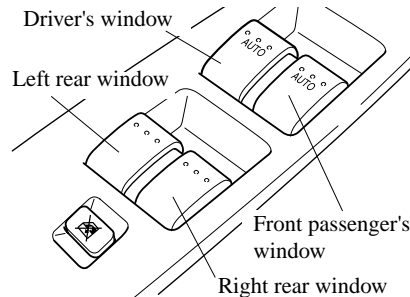

- *The following functions can be performed for the front power windows using the power window master control switches on the driver's door or front passenger's door switch.*
  - *Manual opening/closing*
  - *Auto-opening/closing*
  - *Two-step down function*

Knowing Your Mazda

## Doors and Locks

### Manual opening/closing

To open a power window to the desired position, lightly hold down the switch. To close the power window to the desired position, lightly pull up the switch.

#### Master control switches

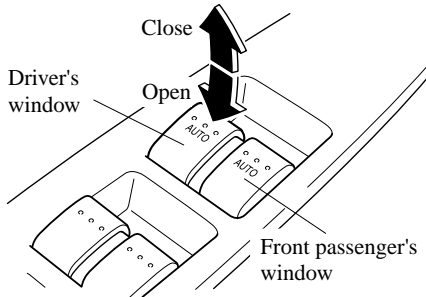

#### Front passenger switch

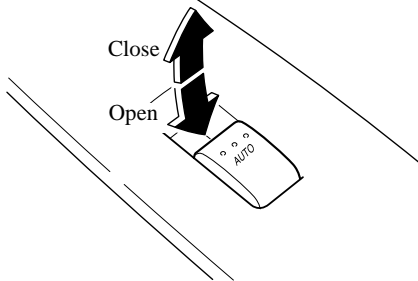

### Auto-opening/closing

To fully open a power window automatically, press the switch completely down.

To fully close the power window automatically, pull the switch completely up.

To stop the power window partway, pull or press the switch in the opposite direction and then release it.

### **NOTE**

#### **(POWER WINDOW RESET PROCEDURE)**

If the battery was disconnected during vehicle maintenance, or for other reasons such as a switch continues to be operated after the window is fully open/close, the power windows will not fully open and close automatically. Resetting of the automatic function can be performed using the master control switches and the front passenger door switch. The power window auto function reset procedure can be done on one or both door switches. The power window auto function will only resume on the side that has been reset.

1. Turn the ignition switch to the ON position.
2. Make sure that the power window lock switch located on the driver's door is not depressed.
3. Press the switch and fully open the power window.
4. Pull up the switch to fully close the power window and continue holding the switch for about 2 seconds after the window fully closed.
5. Repeat Steps 3-4 for each front power window.
6. Make sure that the power windows operate correctly using the door switches.

### **Two-step down function**

With the power window completely closed, press the switch lightly and it will open and stop about 3 cm (1 in) from the top.

If you continue to press and hold the switch, the window will resume opening all the way.

## Knowing Your Mazda Doors and Locks

### NOTE

Pressing the power window switch once when the window is fully closed will only open it about 3 cm (1 in) to allow convenient ventilation of the cabin.

### Canceling the two-step down function

To cancel the two-step down function for the front power windows, carry out the following procedure using the master control switches.

1. Turn the ignition switch to the ON position and complete the following procedure within 5 seconds:  
Press the power window switch 2 times firmly, then pull it 2 times firmly.

#### Master control switches

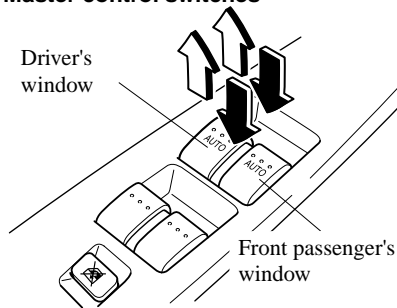

2. Turn the ignition switch to the LOCK position.
3. With the ignition switch in the LOCK position, and within 40 seconds, turn the ignition switch to the ON position and complete the following procedure within 5 seconds:  
Press the power window switch 2 times firmly, then pull 2 times firmly.

### NOTE

- The two-step down function cannot be canceled if the procedure is not completed within the specified times, or the procedure is changed along the way. To redo the procedure, first turn the ignition switch to the LOCK position and proceed from the beginning.
- If you are unable to cancel the function despite carrying out the cancellation procedure, consult an Authorized Mazda Dealer.

### Restoring the two-step down function

With the two-step down function in the canceled state, repeat the previous procedure for canceling the function on each door switch and it will be restored.

### NOTE

If you are unable to restore the function despite doing the restore procedure, consult an Authorized Mazda Dealer.

### Jam-safe window

If a person's hands, head or an object blocks the window during the manual closing operation or the auto-closing operation, the window will stop and open halfway.

### **⚠ WARNING**

**Make sure nothing blocks the window just before it reaches the fully closed position or while fully holding up the power window switch:**

Blocking the power window just before it reaches the fully closed position or while fully holding up the power window switch is dangerous. In this case, the jam-safe function cannot prevent the window from stopping. If fingers are caught, serious injuries could occur.

Knowing Your Mazda

## Doors and Locks

### NOTE

- Depending on driving conditions, a closing power window could stop and start opening when the window feels a shock that is similar to something blocking it. In the event the jam-safe function activates and the power window cannot be closed automatically, pull and hold the switch fully and the window will close.
- The jam-safe window function does not operate until the system is re-initialized.

### Engine-off power window operation

The power window can be operated for about 40 seconds after the ignition switch is turned from the ON position to the ACC or LOCK position with all doors closed. If either front door is opened, the power window will be inoperable.

### NOTE

- For engine-off operation of the power window, the switch must be held up firmly throughout window closure because the auto-closing function will be inoperable.
- The two-step down function is inoperable during engine-off operation.

### ▼ Operating the Rear Power Windows

The power windows may be operated when the power window lock switch on the driver's door is in the unlocked position.

A rear power windows may be opened or closed using the power window master control switches on the driver's door.

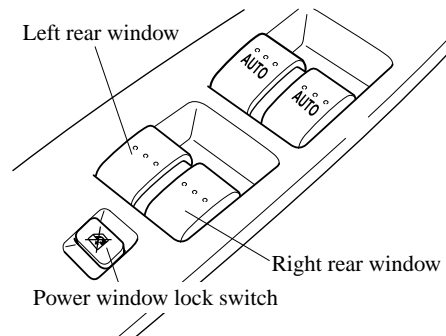

To open the power window to the desired position, hold down the switch. To close the power window to the desired position, pull up the switch.

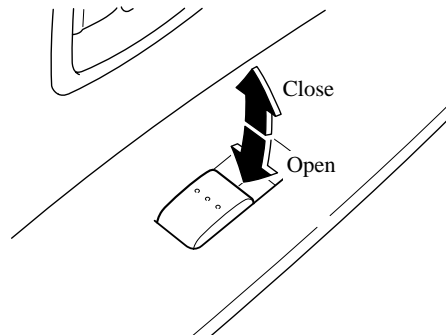



## Knowing Your Mazda Doors and Locks

### **Engine-off power window operation**

The power windows can be operated for about 40 seconds after the ignition switch is turned from the ON position to the ACC or LOCK position with all doors closed. If either front door is opened, the power windows will be inoperable.

### **▼ Power Window Lock Switch**

With the lock switch in the unlocked position, all power windows on each door can be operated.

With the lock switch in the locked position, only the driver's side power window can be operated.

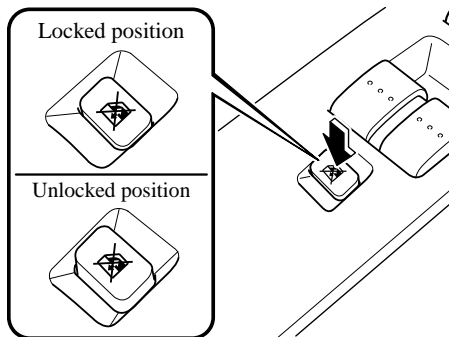

### **⚠ WARNING**

**Unless a passenger needs to operate a power window, keep the power window lock switch in the locked position:**

*Unintentional power window operation is dangerous. A person's hands, head, or neck could be caught by the window and result in serious injury.*

### **NOTE**

*When the power window lock switch is in the locked position, the light on front passenger's power window switch turns off. The light may be difficult to see depending on the surrounding brightness.*

### **▼ Opening/Closing the Power Windows from Outside**

The front power windows can be opened or closed from outside the vehicle after the doors and the liftgate are closed.

The front power windows may be operated when the power window lock switch on the driver's door is in the lock or unlocked position.

### **⚠ WARNING**

**Make sure the opening is clear before closing a window:**

*Closing power windows are dangerous. A person's hands, head, or even neck could be caught by the window and result in serious injury or even death.*

*This warning applies especially to children.*

### **NOTE**

*The power windows cannot be opened or closed from outside the vehicle under the following condition:*

- A door or the liftgate is opened.
- The key is inserted into the ignition switch.
- **(With advanced key)**

*The start knob is in any position except LOCK.*

Knowing Your Mazda

## Doors and Locks

### Opening

Because nobody likes getting into a very hot car, Mazda has introduced a way to open the two front windows and the moonroof as you approach the vehicle to get the air moving before you get in.

### **⚠ WARNING**

**Use the auto-window function only when you can see the vehicle and it is in a secure area:**

*Do not let children play with your keys. If they open the window without your knowing, the open windows are an even bigger invitation to a thief than leaving the doors unlocked.*

The windows can be opened for ventilating the cabin before getting in the vehicle.

### **With unlock button (Keyless entry system)**

Press once, then press again within 1.5 seconds and hold.

After the doors and the liftgate are unlocked, the two front windows and the moonroof open while the unlock button is pressed.

To stop the windows and the moonroof while opening, release the button.

If the operation is performed from the beginning again, the windows and the moonroof open.

### Advanced key

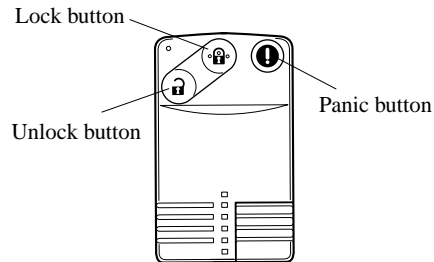

### Retractable type key

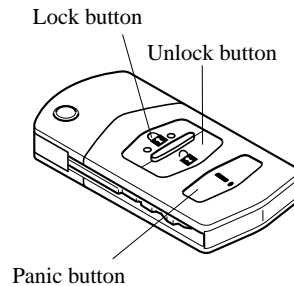

### **NOTE**

- The unlock button does not operate unless it is pressed twice sequentially.
- The lock button cannot be used to close the power windows.

### **With key**

1. Insert the key in the driver's door key cylinder.

## Knowing Your Mazda Doors and Locks

2. Turn the key toward the front and hold it. After the doors and the liftgate are unlocked, the windows fully open automatically.

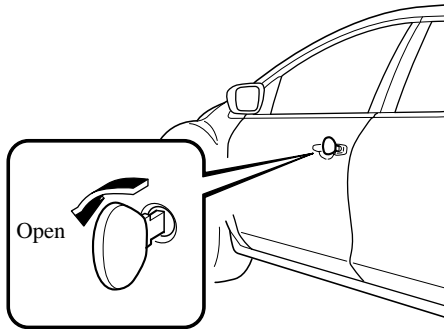

To stop this operation, turn the key to the center position, then turn it toward the front again.

### **NOTE**

*The window opening operation also can be stopped by turning the key toward the back. However, the doors and the liftgate will lock.*

### **Closing**

The windows can be closed in case they are left open after getting out of the vehicle.

### **NOTE**

#### **(With advanced key)**

*If the auto-lock function (page 3-8) has been activated, the doors and the liftgate automatically lock as you walk away from the vehicle, however, the power windows cannot be closed. When leaving the vehicle, close the windows using the power window switch inside the vehicle, the key, or a request switch.*

#### **With key**

1. Insert the key in the driver's door key cylinder.

2. Turn the key toward the back and hold it. After the doors and the liftgate are locked, the windows close as long as the key is turned.

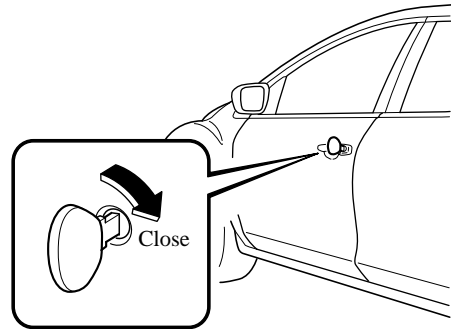

#### **With request switch on the driver's door (Advanced key)**

1. If the doors and the liftgate are locked, unlock them.
2. Press and hold the request switch on the driver's door. After the doors and the liftgate are locked, the windows close as long as the request switch is pressed.

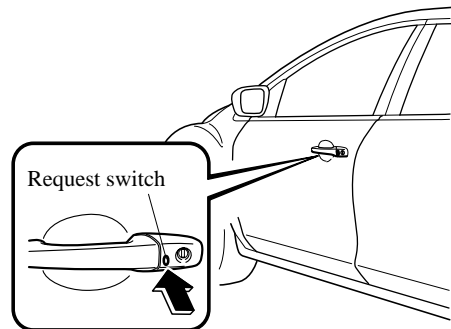

Knowing Your Mazda

## Doors and Locks

### Fuel-Filler Lid and Cap

#### **⚠ WARNING**

*When removing the fuel cap, loosen the cap slightly and wait for any hissing to stop. Then remove it:*

*Fuel spray is dangerous. Fuel can burn skin and eyes and cause illness if ingested. Fuel spray is released when there is pressure in the fuel tank and the fuel cap is removed too quickly.*

*Before refueling, stop the engine, and always keep sparks and flames away from the filler neck:*

*Fuel vapor is dangerous. It could be ignited by sparks or flames causing serious burns and injuries.*

*Additionally, use of the incorrect fuel filler cap or not using a fuel filler cap may result in fuel leak, which could result in serious burns or death in an accident.*

#### **⚠ CAUTION**

*Always use only a genuine Mazda fuel cap or an approved equivalent, available at an Authorized Mazda Dealer. The wrong cap can result in a serious malfunction of the fuel and emission control systems. It may also cause the check engine light in the instrument cluster to illuminate.*

#### ▼ Fuel-Filler Lid

To open, pull up the remote fuel-filler lid release.

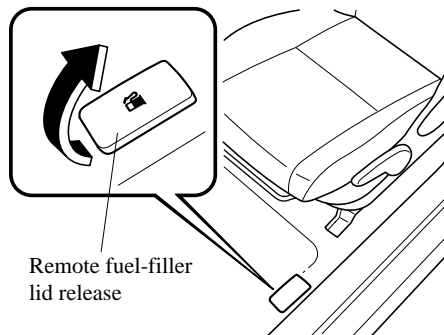

#### ▼ Fuel-Filler Cap

To remove the filler cap, turn it counterclockwise.

To close the filler cap, turn it clockwise until two or more clicks are heard.

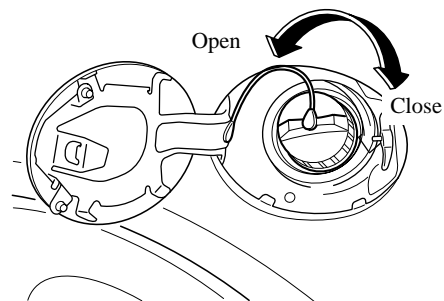

Knowing Your Mazda  
**Doors and Locks**

**⚠ CAUTION**

*Make sure the fuel-filler cap is tightened securely. The check engine light may illuminate when the cap isn't tightened securely. If the light remains on (even after you have tightened the cap securely, driven, and restarted the engine several times), it may indicate a different problem. Contact an Authorized Mazda Dealer as soon as possible.*

**Hood**

**⚠ WARNING**

**Always check that the hood is closed and securely locked:**

*A hood that is not closed and securely locked is dangerous as it could fly open while the vehicle is moving and block the driver's vision which could result in a serious accident.*

**▼ Opening the Hood**

1. With the vehicle parked, pull the release handle to unlock the hood.

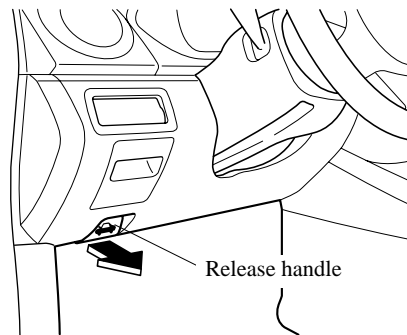

2. Insert your hand into the hood opening and Slide the hood latch to the right and lift the hood.

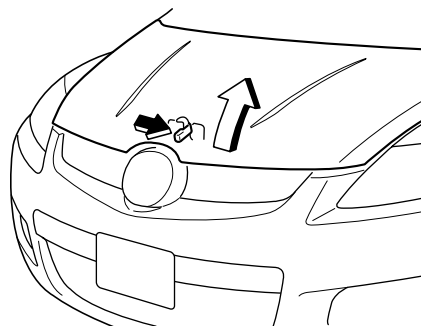

Knowing Your Mazda

## Doors and Locks

3. Grasp the support rod in the padded area and secure it in the stay hole indicated by the arrow to hold the hood open.

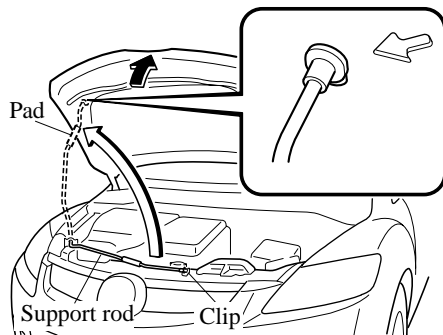

### ▼ Closing the Hood

1. Check under the hood area to make certain all filler caps are in place and all loose items (e.g. tools, oil containers, etc.) have been removed.
2. Insert the support rod in its clip while holding up the hood. Verify that the support rod is secured in the clip before closing the hood.
3. Close the hood so that it locks securely.

## Moonroof\*

The moonroof can be opened or closed electrically only when the ignition switch is in the ON position.

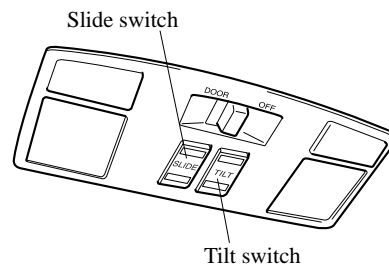

### ⚠ WARNING

**Do not let passengers stand up or extend part of the body through the open moonroof while the vehicle is moving:**

*Extending the head, arms, or other parts of the body through the moonroof is dangerous. The head or arms could hit something while the vehicle is moving. This could cause serious injury or death.*

**Make sure the opening is clear before closing the moonroof:**

*A closing moonroof is dangerous. The hands, head, or even neck of a person—especially a child—could be caught in it as it closes, causing serious injury or even death.*

### NOTE

*After washing your Mazda or after it rains, wipe the water off the moonroof before operating it to avoid water penetration which could cause rust and water damage to your headliner.*

## Knowing Your Mazda Doors and Locks

### ▼ Operating the Moonroof

#### Tilt Operation

The rear of the moonroof can be tilted open to provide more ventilation.

To fully tilt automatically, momentarily push the rear of the tilt switch.  
To fully close automatically, momentarily push the front of the tilt or slide switch.

To stop tilting partway, push any part of the tilt or slide switch.

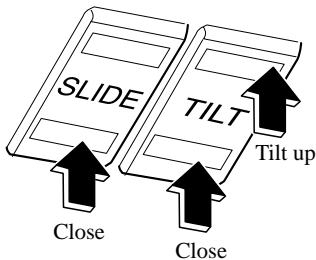

#### Slide Operation

To fully open automatically, momentarily push the rear of the slide switch.  
To fully close automatically, momentarily push the front of the tilt or slide switch.

To stop sliding partway, push any part of the tilt or slide switch.

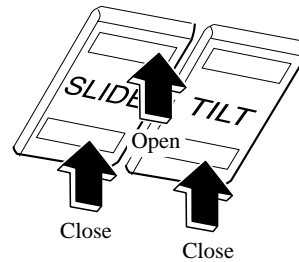

#### Power moonroof initialization procedure

If the battery had been disconnected during vehicle maintenance or for other reasons, the moonroof may not fully open or close. The moonroof's jam-safe function does not function while the moonroof is initializing. Carry out the following procedure to resume operation:

1. Turn the ignition switch to the ON position.
2. Push the rear of the tilt switch, to partially tilt open the rear of the moonroof.

#### **NOTE**

*If the re-initialization procedure is performed while the moonroof is in the slide position (partially open) it closes before the rear tilts opens.*

3. Repeat the procedure in Step 2. The rear of the moonroof tilts open to the fully open position, then closes a little.

Knowing Your Mazda

## Doors and Locks

### ▼ Engine-off Moonroof Operation

The moonroof can be operated for about 40 seconds after the ignition switch is turned from the ON position to the ACC or LOCK position with all doors closed. If any door is opened, the moonroof will be inoperable.

#### NOTE

*For engine-off operation of the moonroof, the switch must be pushed firmly throughout moonroof closure because the auto-closing function will be inoperable.*

### ▼ Opening/Closing the Moonroof from Outside

The moonroof can be opened or closed from outside the vehicle after the doors and the liftgate are closed.

#### ⚠ WARNING

**Make sure the opening is clear before closing the moonroof:**

*Closing the moonroof is dangerous. A person's hands, head, or even neck could be caught by the moonroof and result in serious injury or even death. This warning applies especially to children and pets.*

#### NOTE

*The moonroof cannot be opened or closed from outside the vehicle under the following condition:*

- A door or the liftgate is opened.
- The key is inserted into the ignition switch.
- (With advanced key)

*The start knob is pushed into the ignition switch.*

### Opening

Because nobody likes getting into a very hot car, Mazda has introduced a way to open the two front windows and the moonroof as you approach the vehicle to get the air moving before you get in.

#### ⚠ WARNING

**Use the auto-moonroof function only when you can see the vehicle and it is in a secure area:**

*Do not let children play with your keys. If they open the moonroof without your knowing, the open moonroof is an even bigger invitation to a thief than leaving the doors unlocked.*

The moonroof can be opened for ventilating the cabin before getting in the vehicle.

### With unlock button (Keyless entry system)

Press once, then press again within 1.5 seconds and hold.

After the doors and the liftgate are unlocked, the two front windows and the moonroof open as long as the unlock button is pressed.

### Advanced key

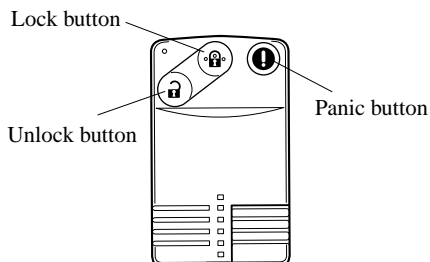



## Knowing Your Mazda Doors and Locks

### Retractable type key

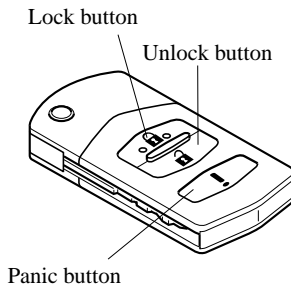

To stop the windows and the moonroof from opening, release the button. If the operation is performed from the beginning again, the windows and the moonroof open.

#### **NOTE**

- The unlock button does not operate unless it is pressed twice sequentially.
- The lock button cannot be used to close the moonroof.

### With key

1. Insert the key in the driver's door key cylinder.

2. Turn the key toward the front and hold it. After the doors and the liftgate are unlocked, the moonroof fully opens automatically.

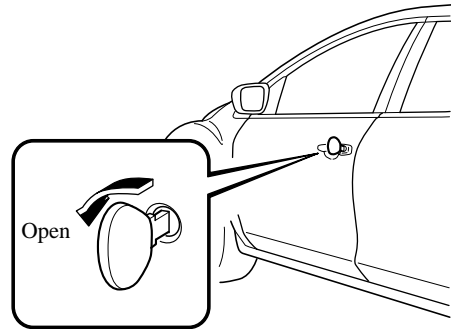

To stop this operation, turn the key to the center position, then turn it toward the front again.

#### **NOTE**

The moonroof opening operation also can be stopped by turning the key toward the back. However, the doors and the liftgate will lock.

### **Closing**

The moonroof can be closed in case it is left open after getting out of the vehicle.

#### **NOTE**

##### **(With advanced key)**

If the auto-lock function (page 3-8) has been activated, the doors and the liftgate automatically lock as you walk away from the vehicle, however, for safety reasons, the moonroof cannot be closed. When leaving the vehicle, close the moonroof using the tilt or slide switch inside the vehicle, the key, or a request switch.

### With key

1. Insert the key in the driver's door key cylinder.

Knowing Your Mazda

## Doors and Locks

2. Turn the key toward the back and hold it. After the doors and the liftgate are locked, the moonroof closes as long as the key is turned.

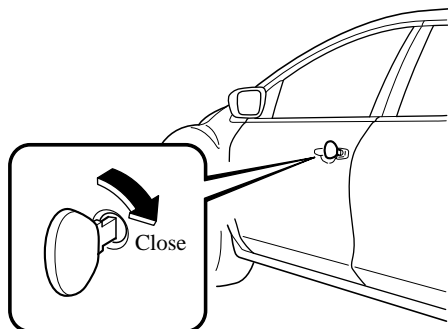

### With request switch on the driver's door (Advanced key)

1. If the doors and the liftgate are locked, unlock them.
2. Press the request switch on the driver's door and hold it. After the doors and the liftgate are locked, the moonroof closes as long as the request switch is pressed.

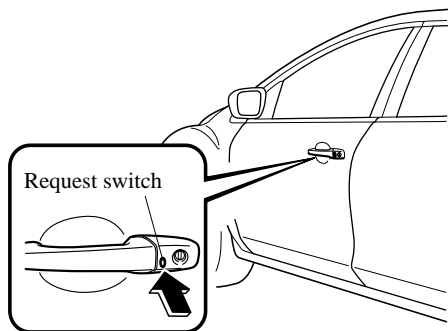

### ▼ Jam-safe Moonroof

If a person's hands, head or an object blocks the moonroof during closing operation, the moonroof will stop and open halfway.

#### **⚠ WARNING**

***Make sure nothing blocks the moonroof just before it reaches the fully closed position:***

*Blocking the moonroof just before it reaches the closed position is dangerous.*

*In this case, the jam-safe function cannot prevent the moonroof from stopping. If fingers are caught, serious injuries could occur.*

#### **NOTE**

- Depending on driving conditions, a closing moonroof could stop and start opening when the moonroof feels a shock that is similar to something blocking it.
- The moonroof's jam-safe function does not function while the moonroof is initializing.

Knowing Your Mazda  
**Doors and Locks**

▼ **Sunshade**

The sunshade can be opened and closed by hand.

The sunshade opens automatically when the moonroof is opened, but must be closed by hand.

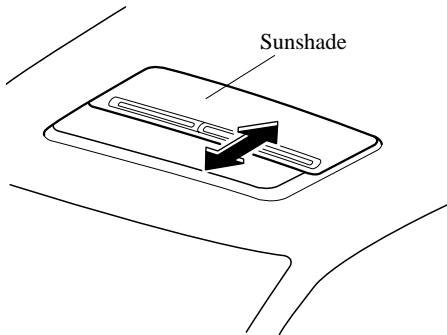

**⚠ CAUTION**

- *The sunshade does not tilt. To avoid damaging the sunshade, do not push up on it.*
- *Do not close the sunshade while the moonroof is opening. Trying to force the sunshade closed could damage it.*

Knowing Your Mazda

## Security System

### Immobilizer System (with Advanced Key)

The immobilizer system allows the engine to start only with an advanced key the system recognizes.

If someone attempts to start the engine with an unrecognized key, the engine will not start, thereby helping to prevent the theft of your vehicle.

#### CAUTION

- Radio equipment like this is governed by laws in the United States.  
*Changes or modifications not expressly approved by the party responsible for compliance could void the user's authority to operate the equipment.*
- To avoid damage to the key, do not:
  - Drop the key.
  - Get the key wet.
  - Expose the key to any kind of magnetic field.
  - Expose the key to high temperatures on places such as the dashboard or hood, under direct sunlight.

#### CAUTION

*Do not allow the following when starting the engine with the auxiliary key due to an advanced key dead battery or other malfunction. Otherwise the signal from the auxiliary key will not be received correctly and the engine may not start.*

- *Metal parts of other keys or metal objects touch the key grip.*
- *Spare auxiliary keys or keys for other vehicles equipped with an immobilizer system touch or come near the auxiliary key.*
- *Equipment containing electronic components or cards with magnetic strips such as credit cards come near the auxiliary key.*

#### NOTE

- **(U.S.A.)**  
*This device complies with Part 15 of the FCC Rules. Operation is subject to the following two conditions: (1) this device may not cause harmful interference, and (2) this device must accept any interference received, including interference that may cause undesired operation.*
- **(CANADA)**  
*This device complies with RSS-210 of Industry CANADA. Operation is subject to the following two conditions: (1) this device may not cause interference, and (2) this device must accept any interference, including interference that may cause undesired operation of the device.*

## Knowing Your Mazda Security System

### ▼ Operation

#### Arming

The system is armed when the ignition switch is turned from the ON position to the ACC or LOCK position. The security indicator light in the instrument cluster flashes every 2 seconds until the system is disarmed.



#### Disarming

The system is disarmed when the ignition switch is turned to the ON position with the registered advanced key. The security indicator light illuminates for about 3 seconds and goes out.

If the engine doesn't start with the correct ignition key, and the security indicator light keeps illuminating or flashing, the system may have a malfunction. Consult an Authorized Mazda Dealer.

#### **NOTE**

- The engine may not start and the security indicator light may illuminate or flash if the advanced key is placed in an area where it is difficult for the system to detect the signal, such as on the dashboard, or in the glove box. Move the advanced key to another place, turn the ignition switch to the LOCK position, and then restart the engine.
- Signals from a TV or radio station, or from a transceiver or a mobile telephone could interfere with your immobilizer system. If you are using the proper advanced key and the engine fails to start, check the security indicator light. If the indicator light is flashing, turn the ignition switch to the ACC or LOCK position and wait for a while, then restart the engine. If it doesn't start after 3 or more tries, contact an Authorized Mazda Dealer.
- If the security indicator light flashes continuously while you are driving, don't shut off the engine. Go to an Authorized Mazda Dealer and have it checked. If the engine is shut off while the indicator light is flashing, you won't be able to restart it.
- Since the electronic codes are reset when repairing the immobilizer system, the advanced key (including auxiliary key) are needed. Bring all the advanced keys (including auxiliary keys) to an Authorized Mazda Dealer.

Knowing Your Mazda

## Security System

### ▼ Maintenance

If you have a problem with the immobilizer system or the key, consult an Authorized Mazda Dealer.

#### NOTE

- *The advanced keys (including auxiliary key) carry a unique electronic code. For this reason, and to assure your safety, obtaining a replacement advanced key (including auxiliary key) requires some waiting time. They are only available through an Authorized Mazda Dealer.*
- *Always keep a spare advanced key in case one is lost. If an advanced key is lost, consult an Authorized Mazda Dealer as soon as possible.*
- *If you lose an advanced key (including auxiliary key), an Authorized Mazda Dealer will reset the electronic codes of your remaining advanced keys (including auxiliary keys) and immobilizer system. Bring all the remaining advanced keys (including auxiliary keys) to an Authorized Mazda Dealer to reset. Starting the vehicle with a key that has not been reset is not possible.*

### ▼ Modification and Add-On Equipment

Mazda cannot guarantee the immobilizer system's operation if the system has been modified or if any add-on equipment has been installed to it.

#### **⚠ CAUTION**

*To avoid damage to your vehicle, do not modify the system or install any add-on equipment to the immobilizer system or the vehicle.*

### Immobilizer System (without Advanced Key)

The immobilizer system allows the engine to start only with a key the system recognizes.

If someone attempts to start the engine with an unrecognized key, the engine will not start, thereby helping to prevent the theft of your vehicle.

#### **⚠ CAUTION**

- *Radio equipment like this is governed by laws in the United States. Changes or modifications not expressly approved by the party responsible for compliance could void the user's authority to operate the equipment.*
- *To avoid damage to the key, do not:*
  - *Drop the key.*
  - *Get the key wet.*
  - *Expose the key to any kind of magnetic field.*
  - *Expose the key to high temperatures on places such as the dashboard or hood, under direct sunlight.*

## Knowing Your Mazda Security System

### **CAUTION**

When starting the engine do not allow the following, as the engine may not start due to the electronic signal from the ignition key not being transmitted correctly.

- A key ring rests on the key grip.

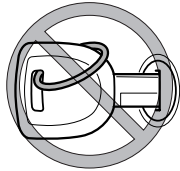

- Metal parts of other keys or metal objects touch the key grip.



- Spare keys or keys for other vehicles equipped with an immobilizer system touch or come near the key grip.

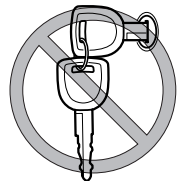

- Devices for electronic purchases, or security passage touch or come near the key.

### **NOTE**

- **(U.S.A.)**

*This device complies with Part 15 of the FCC Rules. Operation is subject to the following two conditions: (1) this device may not cause harmful interference, and (2) this device must accept any interference received, including interference that may cause undesired operation.*

- **(CANADA)**

*This device complies with RSS-210 of Industry CANADA. Operation is subject to the following two conditions: (1) this device may not cause interference, and (2) this device must accept any interference, including interference that may cause undesired operation of the device.*

### **▼ Operation**

#### **Arming**

The system is armed when the ignition switch is turned from the ON to the ACC position.

The security indicator light in the instrument panel flashes every 2 seconds until the system is disarmed.



#### **Disarming**

The system is disarmed when the ignition switch is turned to the ON position with the correct ignition key.

The security indicator light illuminates for about 3 seconds and goes out.

Knowing Your Mazda

## Security System

If the engine doesn't start with the correct ignition key, and the security indicator light keeps illuminating or flashing, the system may have a malfunction. Consult an Authorized Mazda Dealer.

### NOTE

- *If the security indicator light comes on and stays on when the ignition switch is turned to the ON position, the engine will not start.*
- *Signals from a TV or radio station, or from a transceiver or a mobile telephone, could interfere with your immobilizer system. If you are using the proper key and your engine fails to start, check the security indicator light. If it is flashing, remove the ignition key and wait 2 seconds or more, then reinsert it and try starting the engine again. If it doesn't start after 3 or more tries, contact an Authorized Mazda Dealer.*
- *If the security indicator light flashes continuously while you are driving, don't shut off the engine. Go to an Authorized Mazda Dealer and have it checked. If you shut off the engine while the light is flashing you won't be able to restart it.*
- *Since the electronic codes are reset when repairing the immobilizer system, the keys are needed. Bring all the existing keys to an Authorized Mazda Dealer.*

### ▼ Maintenance

If you have a problem with the immobilizer system or the key, consult an Authorized Mazda Dealer.

### NOTE

- *The keys carry a unique electronic code. For this reason, and to assure your safety, obtaining replacement key requires some waiting time. They are only available through an Authorized Mazda Dealer.*
- *Always keep a spare key, in case one is lost. If a key is lost, contact an Authorized Mazda Dealer as soon as possible.*
- *If you lose a key, an Authorized Mazda Dealer will reset the electronic codes of your remaining keys and immobilizer system. Bring all the remaining keys to an Authorized Mazda Dealer to reset. Starting the vehicle with a key that has not been reset is not possible.*

### ▼ Modification and Add-On Equipment

Mazda cannot guarantee the immobilizer system's operation if the system has been modified or if any add-on equipment has been installed to it.

### CAUTION

*To avoid damage to your vehicle, do not modify the system or install any add-on equipment to the immobilizer system or the vehicle.*



Knowing Your Mazda  
**Security System**

## Theft-Deterrent System \*

If the theft deterrent system detects an inappropriate entry into the vehicle, which could result in the vehicle or its contents being stolen, the alarm alerts the surrounding area of an abnormality by sounding the horn and flashing the hazard warning lights.

Refer to Operation on page 3-51.

### NOTE

- *The theft-deterrent system operates with the key or the keyless entry system transmitter.*

- **(With advanced key)**

*The theft-deterrent system can also be operated using a request switch or the start knob.*

*The system operates only when the driver is in the vehicle or within operational range while the advanced key is being carried.*

- *The system will not function unless it is properly armed. To properly secure the vehicle, always make sure all windows are completely closed and all doors and the liftgate are locked before leaving the vehicle. Remember to take your key and transmitter.*

### ▼ Operation

#### System triggering conditions

The horn sounds intermittently and the hazard warning lights flash for about 25 seconds when the system is triggered by any one of the following:

- Forcing open a door, the hood or the liftgate.
- Unlocking a door with the inside door-lock knob.
- Unlocking a door with the door lock switch.
- Opening a door by operating an inside door-lock knob.

- Opening the hood by operating the hood release handle.

If the system is triggered again, the lights and horn will activate until a door or the liftgate is unlocked with the key or with the transmitter.

#### **(With advanced key)**

The lights and horn can also be deactivated by pressing a request switch.

### ▼ How to Arm the System

1. Remove the key from the ignition switch.

#### **(With advanced key)**

Turn the start knob to the LOCK position.

2. Make sure the hood is closed. Close and lock all doors and the liftgate from the outside using the key or press the lock button on your keyless entry system transmitter.

#### **(With advanced key)**

Press a request switch or the lock button on the transmitter.

#### **(Without advanced key)**

The following method will also arm the theft-deterrent system:

Close the hood and the liftgate. Press the area on the door-lock switch marked “” once. Close all doors.

The hazard warning lights will flash once. The theft deterrent system can also be armed by activating the auto re-lock function with all the doors, the liftgate and the hood closed.

### NOTE

*Locking the doors with the inside door-lock knob will not arm the system.*

3. After 20 seconds, the system is fully armed.

Knowing Your Mazda

## Security System

### NOTE

#### • **Auto re-lock function**

*After unlocking with the transmitter or the request switch, all doors and the liftgate will automatically lock and the hazard warning lights will flash if any of the following operations are not performed within about 30 seconds.*

- *A door or the liftgate is opened.*
- *The auxiliary key inserted into the ignition switch (with advanced key).*
- *The start knob is pushed (with advanced key).*
- *The system will disarm if one of the following operations takes place within 20 seconds after closing and locking all the doors and the liftgate:*
  - *Pressing the unlock button on the transmitter.*
  - *Any door or the liftgate is opened.*
  - *Unlocking a door with the inside door-lock knob.*
  - *The hood is opened.*
  - *The key is inserted in the ignition switch.*
  - **(With advanced key)**
    - *The start knob is pressed into the ignition switch or a request switch is pressed.*
    - *The ignition switch is turned to the ON position.*

*To rearm the system, do the arming procedure again.*

### ▼ To Turn off an Armed System

An armed system can be turned off by any one of the following methods:

- Unlock a door with the key.
- Press the unlock button on the keyless entry system transmitter.
- Insert the key into the ignition switch and turn it to the ON position.

### • (With advanced key)

- Press a request switch or the unlock button on the transmitter.
- Turn the start knob to the ON position.

The hazard warning lights will flash twice to indicate that the system is turned off.

### ▼ To Stop an Alarm

A triggered alarm can be turned off by any one of the following methods:

- Unlock a door with the key.
- Press the unlock button on the keyless entry system transmitter.
- The engine is started with the ignition key or the start knob.
- **(With advanced key)**
  - Press a request switch.
  - Press the unlock button on the transmitter.

### NOTE

*If you have any problem with the theft-deterrent system, consult an Authorized Mazda Dealer.*

### ▼ Theft-Deterrent Labels



A label indicating that your vehicle is equipped with a Theft-Deterrent System is in the glove box.

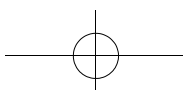

Knowing Your Mazda  
**Security System**

---

Mazda recommends that you affix it to the lower rear corner of a front door window.

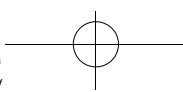
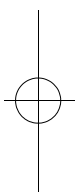
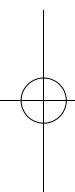

Knowing Your Mazda

## Steering Wheel and Mirrors

### Steering Wheel

#### **⚠ WARNING**

**Never adjust the steering wheel while the vehicle is moving:**

*Adjusting the steering wheel while the vehicle is moving is dangerous. Moving it can very easily cause the driver to abruptly turn to the left or right. This can lead to loss of control or an accident.*

#### ▼ Tilt Steering Wheel

To change the angle of the steering wheel, stop the vehicle, pull the tilt wheel release lever under the steering column down, adjust the wheel, then push the release lever up to lock the column.

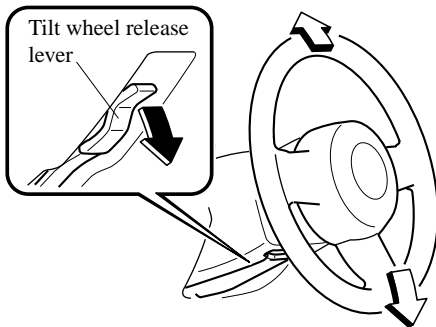

After adjusting, push the wheel up and down to be certain it's locked before driving.

### Mirrors

#### ▼ Outside Mirrors

Check the mirror angles before driving.

#### Mirror type

##### **Flat type (driver's side)**

Flat surface mirror.

##### **Convex type (front passenger side)**

The mirror has single curvature on its surface.

#### **⚠ WARNING**

**Be sure to look over your shoulder before changing lanes:**

*Changing lanes without taking into account the actual distance of the vehicle in the convex mirror is dangerous. You could have a serious accident. What you see in the convex mirror is closer than it appears.*

#### Power mirror

The ignition switch must be in the ACC or ON position.

To adjust:

1. Press the left or right side of the selector switch to choose the left or right side mirror.

## Steering Wheel and Mirrors

2. Depress the mirror switch in the appropriate direction.

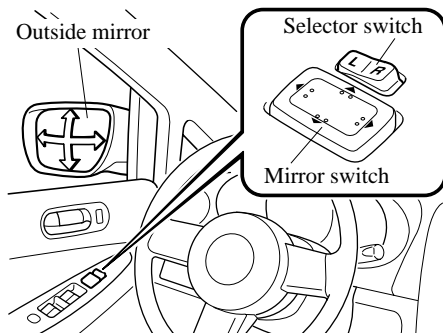

After adjusting the mirror, lock the control by placing the selector switch in the middle position.

### **Folding the mirror**

Fold the outside mirror rearward until it is flush with the vehicle.

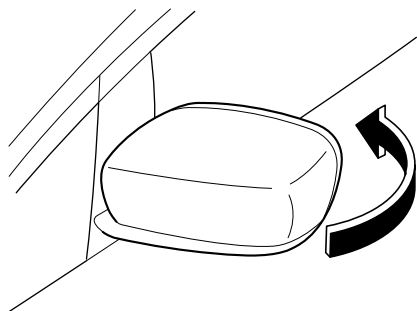

### **⚠ WARNING**

***Always return the outside mirrors to the driving position before you start driving:***

***Driving with the outside mirrors folded in is dangerous. Your rear view will be restricted, and you could have an accident.***

### **Mirror defroster\***

To turn on the mirror defrosters, turn the ignition switch to the ON position and push the rear window defroster switch (page 5-59).

### **▼ Rearview Mirror**

#### **Rearview mirror adjustment**

Before driving, adjust the rearview mirror to center on the scene through the rear window.

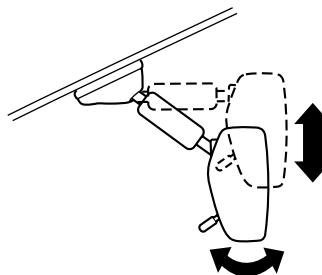

#### **Reducing glare from headlights**

Adjust the mirror with the day/night lever in the day position.

Push the lever forward for day driving. Pull it back to reduce glare from headlights.

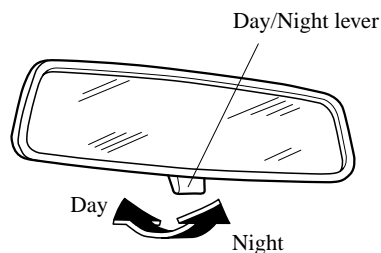

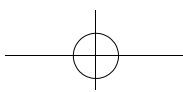

Knowing Your Mazda

## Steering Wheel and Mirrors

---

### **WARNING**

***Do not stack cargo or objects higher than the seatbacks:***

*Cargo stacked higher than the seatbacks is dangerous. It can block your view in the rearview mirror, which might cause you to hit another car when changing lanes.*

**3-56**

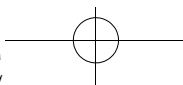

# 4

## Before Driving Your Mazda

Important information about driving your Mazda.

<b>Fuel and Engine Exhaust Precautions .....</b>	<b>4-2</b>
Fuel Requirements .....	4-2
Emission Control System .....	4-3
Engine Exhaust (Carbon Monoxide) .....	4-4
<b>Before Starting the Engine .....</b>	<b>4-5</b>
Before Getting In .....	4-5
After Getting In .....	4-5
<b>Driving Tips .....</b>	<b>4-6</b>
Break-In Period .....	4-6
Money-Saving Suggestions .....	4-6
Hazardous Driving .....	4-7
Rocking the Vehicle .....	4-8
Winter Driving .....	4-8
Driving In Flooded Area .....	4-10
Overloading .....	4-10
Turbocharger Information .....	4-11
<b>Towing .....</b>	<b>4-12</b>
Trailer Towing .....	4-12

Before Driving Your Mazda

## Fuel and Engine Exhaust Precautions

### Fuel Requirements

Vehicles with catalytic converters or oxygen sensors must use **ONLY UNLEADED FUEL**, which will reduce exhaust emissions and keep spark plug fouling to a minimum.

Your Mazda will perform best with fuel listed in the table.

Fuel	Octane Rating* (Anti-knock index)
Premium unleaded fuel	91 [(R+M)/2 method] (96 RON) recommended

\* U.S. federal law requires that octane ratings be posted on gasoline station pumps.

This vehicle is designed to use 91 [(R+M)/2 method] (96RON) or higher gasoline for best performance. If 91 [(R+M)/2 method] (96RON) is not available, 87[(R+M)/2 method] (91RON) gasoline can be used. Use of gasoline lower than 91 [(R+M)/2 method] (96RON) can decrease performance, deteriorate shift quality and cause engine knocking during its use.

#### **CAUTION**

- **USE ONLY UNLEADED FUEL.**  
*Leaded fuel is harmful to the catalytic converter and oxygen sensors and will lead to deterioration of the emission control system and or failures.*
- *Your vehicle can only use oxygenated fuels containing no more than 10% ethanol by volume. Damage to your vehicle may occur when ethanol exceeds this recommendation, or if the gasoline contains any methanol. Stop using gasohol of any kind if your vehicle engine is performing poorly.*
- *Never add fuel system additives. Never add cleaning agents other than those specified by Mazda. Other cleaning agents and additives may damage the system. Consult an Authorized Mazda Dealer.*

Gasoline blended with oxygenates such as alcohol or ether compounds are generally referred to as oxygenated fuels. The common gasoline blend that can be used with your vehicle is ethanol blended at no more than 10%. Gasoline containing alcohol, such as ethanol or methanol, may be marketed under the name "Gasohol".

Vehicle damage and drivability problems resulting from the use of the following may not be covered by the Mazda warranty.

- Gasohol containing more than 10% ethanol.
- Gasoline or gasohol containing methanol.
- Leaded fuel or leaded gasohol.



Before Driving Your Mazda

## Fuel and Engine Exhaust Precautions

### Emission Control System

Your vehicle is equipped with an emission control system (the catalytic converter is part of this system) that enables your vehicle to comply with existing exhaust emissions requirements.

#### **WARNING**

**Never park over or near anything flammable:**

*Parking over or near anything flammable, such as dry grass, is dangerous. Even with the engine turned off, the exhaust system remains very hot after normal use and could ignite anything flammable. A resulting fire could cause serious injury or death.*

#### **CAUTION**

*Ignoring the following precautions could cause lead to accumulate on the catalyst inside the converter or cause the converter to get very hot. Either condition will damage the converter and cause poor performance.*

- **USE ONLY UNLEADED FUEL.**
- *Don't drive your Mazda with any sign of engine malfunction.*
- *Don't coast with the ignition switch turned off.*
- *Don't descend steep grades in gear with the ignition switch turned off.*
- *Don't operate the engine at high idle for more than 2 minutes.*
- *Don't tamper with the emission control system. All inspections and adjustments must be made by a qualified technician.*
- *Don't push-start or pull-start your vehicle.*

#### **NOTE**

*Under U.S. federal law, any modification to the original-equipment emission control system before the first sale and registration of a vehicle is subject to penalties. In some states, such modification made on a used vehicle is also subject to penalties.*

#### **NOTE**

*While the engine is off, the sound of a valve opening and closing can be heard at the middle rear of the vehicle, however this does not indicate an abnormality. Your vehicle has a self-checking device and it operates while the engine is off.*

Before Driving Your Mazda

## Fuel and Engine Exhaust Precautions

### Engine Exhaust (Carbon Monoxide)

#### WARNING

**Do not drive your vehicle if you smell exhaust gas inside the vehicle:**

*Engine exhaust gas is dangerous. This gas contains carbon monoxide (CO), which is colorless, odorless, and poisonous. When inhaled, it can cause loss of consciousness and death. If you smell exhaust gas inside your vehicle, keep all windows fully open and contact an Authorized Mazda Dealer immediately.*

**Do not run the engine when inside an enclosed area:**

*Running the engine inside an enclosed area, such as a garage, is dangerous. Exhaust gas, which contains poisonous carbon monoxide, could easily enter the cabin. Loss of consciousness or even death could occur.*

**Open the windows or adjust the heating or cooling system to draw fresh air when idling the engine:**

*Exhaust gas is dangerous. When your vehicle is stopped with the windows closed and the engine running for a long time even in an open area, exhaust gas, which contains poisonous carbon monoxide, could enter the cabin. Loss of consciousness or even death could occur.*

**Clear snow from underneath and around your vehicle, particularly the tail pipe, before starting the engine:**

*Running the engine when a vehicle is stopped in deep snow is dangerous. The exhaust pipe could be blocked by the snow, allowing exhaust gas to enter the cabin. Because exhaust gas contains poisonous carbon monoxide, it could cause loss of consciousness or even death to occupants in the cabin.*

Before Driving Your Mazda

## Before Starting the Engine

### Before Getting In

- Be sure the windows, outside mirrors, and outside lights are clean.
- Inspect inflation pressures and condition of tires.
- Look under the vehicle for any sign of fluid leaks.
- If you plan to back up, make sure nothing is in your way.

#### **NOTE**

*Engine oil, engine coolant, brake fluid, washer fluid, and other fluid levels should be inspected. See Maintenance, Section 8.*

### After Getting In

- Are all doors closed and locked?
  - Is the seat adjusted properly?
  - Are the inside and outside mirrors adjusted?
  - Is everyone's seat belt fastened?
  - Check all gauges.
  - Check all warning lights when the ignition switch is turned to the ON position.
  - Release the parking brake and make sure the brake warning light goes off.
- Always be thoroughly familiar with your Mazda.

Before Driving Your Mazda

## Driving Tips

### Break-In Period

No special break-in is necessary, but a few precautions in the first 1,000 km (600 miles) may add to the performance, economy, and life of your Mazda.

- Don't race the engine.
- Don't maintain one constant speed, either slow or fast, for a long period of time.
- Don't drive constantly at full-throttle or high engine rpm for extended periods of time.
- Avoid unnecessary hard stops.
- Avoid full-throttle starts.
- Don't tow a trailer.

### Money-Saving Suggestions

How you operate your Mazda determines how far it will travel on a tank of fuel. Use these suggestions to help save money on fuel and repairs.

- Avoid long warm-ups. Once the engine runs smoothly, begin driving.
- Avoid fast starts.
- Keep the engine tuned. Follow the maintenance schedule (page 8-3) and have an Authorized Mazda Dealer perform inspections and servicing.
- Use the air conditioner only when necessary.
- Slow down on rough roads.
- Keep the tires properly inflated.
- Don't carry unnecessary weight.
- Don't rest your foot on the brake pedal while driving.
- Keep the wheels in correct alignment.
- Keep windows closed at high speeds.
- Slow down when driving in crosswinds and headwinds.

### **WARNING**

***Never stop the engine when going down a hill:***

*Stopping the engine when going down a hill is dangerous. This causes the loss of power steering and power brake control, and may cause damage to the drivetrain. Any loss of steering or braking control could cause an accident.*

### Hazardous Driving

#### ▼ Driving on Slippery Surface

#### **⚠ WARNING**

**Be extremely careful if it is necessary to downshift on slippery surfaces:**

*Downshifting into lower gear while driving on slippery surfaces is dangerous. The sudden change in tire speed could cause the tires to skid. This could lead to loss of vehicle control and an accident.*

**Do not rely on ABS as a substitute for safe driving:**

*The ABS cannot compensate for unsafe and reckless driving, excessive speed, tailgating (following another vehicle too closely), driving on ice and snow, and hydroplaning (reduced tire friction and road contact because of water on the road surface). You can still have an accident.*

When driving on ice or in water, snow, mud, sand, or similar hazards:

- Be cautious and allow extra distance for braking.
- Avoid sudden braking and sudden maneuvering.
- Do not pump the brakes. Continue to press down on the brake pedal.
- If you get stuck, select a lower gear and accelerate slowly. Do not spin the front wheels.
- For more traction in starting on slippery surfaces such as ice or packed snow, use sand, rock salt, chains, carpeting, or other nonslip material under the front wheels.

#### **NOTE**

*Use snow chains only on the front wheels.*

#### ▼ Roll-over

#### **⚠ WARNING**

**Avoid sharp turns, excessive speed and abrupt maneuvers when driving this vehicle:**

*Sharp turns, excessive speed and abrupt maneuvering of this vehicle is dangerous as it could result in the increased risk of loss of vehicle control, vehicle roll-over, personal injury or death.*

*This vehicle has a higher center of gravity. Vehicles with a higher center of gravity such as utility and AWD vehicles handle differently than vehicles with a lower center of gravity.*

*Utility and AWD vehicles are not designed for cornering at speeds as any more than low profile sports cars are designed to perform satisfactorily under off-road conditions. In addition, utility vehicles have a significantly higher rollover rate than other types of vehicles.*

*RSC might help if you get into trouble, but then it might not be able to allow you to fully recover, always drive carefully with the vehicle's height in mind.*

**Drive carefully when the vehicle is loaded by lowering vehicle speed and applying the brakes earlier:**

*Abrupt maneuvering and sudden braking when driving a loaded vehicle is dangerous as the driving behavior of a vehicle with a high center of gravity is different when it is loaded compared to when it is not, and could result in the loss of vehicle control and an accident.*

Before Driving Your Mazda

## Driving Tips

### Rocking the Vehicle

#### **WARNING**

**Do not spin the wheels at more than 56 km/h (35 mph), and do not allow anyone to stand behind a wheel when pushing the vehicle:**

*When the vehicle is stuck, spinning the wheels at high speed is dangerous. The spinning tire could overheat and explode. This could cause serious injuries.*

#### **CAUTION**

*Too much rocking may cause engine overheating, transaxle failure, and tire damage.*

If you must rock the vehicle to free it from snow, sand or mud, depress the accelerator slightly and slowly move the shift lever from D to R.

### Winter Driving

- Carry emergency gear, including tire chains, window scraper, flares, a small shovel, jumper cables, and a small bag of sand or salt.

Ask an Authorized Mazda Dealer to perform the following precautions:

- Have the proper ratio of antifreeze in the radiator.  
Refer to Engine Coolant on page 8-21.
- Inspect the battery and its cables. Cold reduces battery capacity.
- Inspect the ignition system for damage and loose connections.
- Use washer fluid made with antifreeze—but don't use engine coolant antifreeze for washer fluid (page 8-27).
- Don't use the parking brake in freezing weather as the parking brake may freeze. Instead, shift to P and block the rear wheels.

#### ▼ Snow Tires

##### Use snow tires on all four wheels

Don't go faster than 120 km/h (75 mph) while driving with snow tires. Inflate snow tires 30 kPa (0.3 kgf/cm<sup>2</sup>, 4.3 psi) more than recommended on the tire pressure label (driver's door frame), but never more than the maximum cold-tire pressure shown on the tires.

#### **WARNING**

**Use only the same size and type tires (snow, radial, or non-radial) on all four wheels:**

*Using tires different in size or type is dangerous. Your vehicle's handling could be greatly affected and result in an accident.*

Before Driving Your Mazda  
**Driving Tips**

**CAUTION**

*Check local regulations before using studded tires.*

**NOTE**

*If your vehicle is equipped with the tire pressure monitoring system, the system may not function correctly when using tires with steel wire reinforcement in the sidewalls (page 5-31).*

**▼ Tire Chains**

Check local regulations before using tire chains.

**CAUTION**

- *Chains may affect handling.*
- *Do not go faster than 50 km/h (30 mph) or the chain manufacturer's recommended limit, whichever is lower.*
- *Drive carefully and avoid bumps, holes, and sharp turns.*
- *Avoid locked-wheel braking.*
- *Do not use chains on a temporary spare tire; it may result in damage to the vehicle and to the tire.*
- *Do not use chains on roads that are free of snow or ice. The tires and chains could be damaged.*
- *Chains may scratch or chip aluminum wheels.*

**NOTE**

*If your vehicle is equipped with the tire pressure monitoring system, the system may not function correctly when using tire chains.*

Install the chains on the front tires.  
Do not use chains on the rear tires.  
Please consult an Authorized Mazda Dealer.

**Installing the chains**

1. Secure the chains on the front tires as tightly as possible. Always follow the chain manufacturer's instructions.
2. Retighten the chains after driving 1/2 —1 km (1/4—1/2 mile).

Before Driving Your Mazda

## Driving Tips

### Driving In Flooded Area

#### **WARNING**

*Dry wet brakes by driving very slowly and applying the brakes lightly until brake performance returns to normal:*

*Driving with wet brakes is dangerous. Increased stopping distance or the vehicle pulling to one side when braking could result in a serious accident. Light braking will indicate whether the brakes have been affected.*

#### **CAUTION**

*Do not drive the vehicle on flooded roads as it could cause short circuiting of electrical/electronic parts, or engine damage or stalling from water absorption. If the vehicle has been immersed in water, consult an Authorized Mazda Dealer.*

### Overloading

#### **WARNING**

*Be careful not to overload your vehicle:*

*The gross axle weight rating (GAWR) and the gross vehicle weight rating (GVWR) of your vehicle are on the Motor Vehicle Safety Standard Label on the driver's door frame. Exceeding these ratings can cause an accident or vehicle damage. You can estimate the weight of your load by weighing the items (or people) before putting them in the vehicle.*



## Turbocharger Information

The turbocharger greatly enhances engine power. Its advanced design provides improved operation and requires minimum additional maintenance. To get maximum performance from your turbocharged engine, take note of the following tips:

- The turbocharged engine is designed for optimal operation with premium unleaded gasoline (page 4-2). Do not use fuel with a lower octane rating. Extra fuel additives are NOT recommended.
- Change the engine oil and filter using the turbo engine interval outlined in the maintenance schedule (for your driving condition).
- Use only the recommended engine oil (page 8-19). Extra oil additives are NOT recommended.
- After driving at freeway speeds or up a long hill, idle the engine at least 30 seconds to cool the turbo before turning off the engine. Avoid simply shutting the engine off abruptly after a hard or long drive. Damage to the turbocharger may result.
- Don't race or over-rev the engine when starting. This should not be done with ANY engine, especially not with one that's turbocharged.
- Do not add any aftermarket devices to alter the engine's ignition timing, fuel delivery, or turbo boost pressure. This may lead to serious engine damage and may void your warranty.

Before Driving Your Mazda

## Towing

### Trailer Towing

Your Mazda was designed and built primarily to carry passengers and cargo.

If you tow a trailer, follow these instructions because driver and passenger safety depends on proper equipment and safe driving habits. Towing a trailer will affect handling, braking, durability, performance, and economy.

Never overload vehicle or trailer. Consult an Authorized Mazda Dealer if you need further details.

#### CAUTION

*Don't tow a trailer during the first 1,000 km (600 miles) of your new Mazda. If you do, you may damage the engine, transaxle, differential, wheel bearings, and other power train components.*

#### ▼ Weight Limits

##### TTW and GCWR

The total trailer weight (TTW), gross combination weight rating (GCWR), gross axle weight rating (GAWR), trailer load, and trailer tongue load must be within the prescribed limits.

- The total trailer weight (TTW) is the sum of the weights of the trailer load (trailer weight plus cargo), trailer hitch, vehicle passengers, and vehicle load. Never allow the total trailer weight (TTW) to exceed specifications in the Trailer Towing-Load Table.
- The maximum GCWR is the combination weight of the trailer and load plus the towing vehicle (including trailer hitch, vehicle passengers, and load). It must not exceed specifications in the load table.

##### GAWR and GVWR

Don't exceed front and rear GAWR (gross axle weight rating) and GVWR (gross vehicle weight rating). If you do, vehicle handling, braking, and performance will be affected. These values are also on the Motor Vehicle Safety Certification Label posted on the driver's door frame.





##### High-altitude operation

In a high-altitude operating environment, a gasoline engine loses power at a rate of 3% to 4% per 304 m (1,000 ft) of elevation. In these conditions, a reduction in gross vehicle weight and gross combination weight is recommended.

Before Driving Your Mazda  
**Towing**

**TRAILER TOWING-LOAD TABLE**

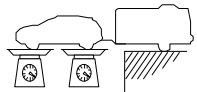
Because vehicle weights vary, adjustments must be made to meet the requirements in this table.

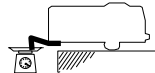
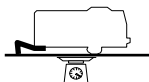
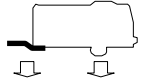
	Item	Model		
		2WD	AWD	
<b>MAX. FRONTAL AREA</b>		2.97 m <sup>2</sup> (32 ft <sup>2</sup> )		
<b>MAX. TTW</b>	Add trailer's weight, load and hitch; vehicle passengers and vehicle load* * i.e. baggage, food, camp gear 	907 kg (2,000 lb)		
<b>MAX. GCWR</b>		2,815 kg (6,206 lb)	2,914 kg (6,424 lb)	
<b>MAX. GAWR</b>		Front	1,150 kg (2,535 lb)	1,189 kg (2,621 lb)
		Rear	1,022 kg (2,253 lb)	1,083 kg (2,388 lb)
<b>MAX. GVWR</b>		2,168 kg (4,780 lb)	2,267 kg (4,998 lb)	
<b>TRAILER-TONGUE LOAD</b>	Tongue load 	Tongue load/Trailer load × 100 = 10% to 15%		
	Trailer load 			
<b>DISTRIBUTION OF TRAILER LOAD</b>		Front	60%	
		Rear	40%	

GCWR: Gross Combination Weight Rating (sum of TTW, vehicle weights and 2 passengers)

GAWR: Gross Axle Weight Rating

GVWR: Gross Vehicle Weight Rating

Before Driving Your Mazda

## Towing

---

### **WARNING**

**Always keep tow loads within specified limits as indicated in the Trailer Towing-Load Table:**

*Attempting to tow loads greater than those specified is dangerous as it may cause serious handling and performance problems that could result in personal injury or vehicle damage, or both.*

**Load your trailer with the weight about 60% toward the front and 40% toward the rear:**

*Loading the trailer with more weight in the rear than in the front is dangerous. Doing so could cause you to lose control. The trailer tongue load must be 10%—15% of the total trailer load (sum of the weights of the trailer and cargo).*

**Always have the total trailer weight and tongue load determined prior to departure:**

*Attempting to tow loads without determining the total trailer weight and tongue load is dangerous. Trailer sway from crosswinds, rough roads or other causes could result in loss of control and a serious accident.*

### **CAUTION**

*The total trailer weight and tongue load can be determined by weighing the trailer on platform scales at a highway weight station or a trucking company.*

### **Trailer Hitch**

Use only a hitch ball recommended by the trailer manufacturer that conforms to the gross trailer weight requirement.

When not towing a trailer, remove the trailer hitch (if detachable) to reduce the possibility of damage as a result of the vehicle being rear-ended.

### **WARNING**

**Always make sure the trailer hitch is securely attached before departure:**

*An unsecured trailer hitch is dangerous as it causes greater trailer sway from crosswinds, rough roads or other causes, resulting in loss of control and a serious accident.*

*Examine all trailer-hitch mounting bolts regularly and tighten any that are loose. If the hitch is removed, seal any open mounting holes to prevent exhaust, dust, water, dirt and other foreign elements from filtering in, possibly endangering personal safety and damaging your vehicle.*

*Do not install a hitch that stiffens the bumper as it will reduce the bumper's performance.*

**Make sure there are no exhaust gas leaks into the passenger compartment if any mounting bolts are connected to the body:**

*Modifying your vehicle exhaust system is dangerous. Exhaust gas entering the vehicle could cause loss of consciousness or even death.*

*When mounting the trailer hitch, make no modifications to the vehicle exhaust system.*

### **CAUTION**

- *Make all hitch adjustments with actual loads. Don't load and unload vehicle while adjusting hitch. This action will change the vehicle height.*
- *Don't use an axle-mounted hitch. This may damage the axle and related parts.*

### ▼ **Tires**

When towing a trailer, make sure all tires are inflated to the recommended cold-tire pressure, as indicated on the tire pressure chart on the driver's door frame. Trailer tire size, load rating, and inflation pressures should conform to tire manufacturer specifications.

### **WARNING**

**Never use the temporary spare tire when towing:**

*Using the temporary spare tire on your vehicle when towing a trailer is dangerous as it could result in tire failure, loss of control, and injury to vehicle occupants.*

Before Driving Your Mazda

## Towing

---

### ▼ Safety Chains

Safety chains must be used as a precautionary measure should the trailer become unintentionally unhitched. They should cross under the trailer tongue and attach to the hitch. Leave enough slack to allow full turns. Consult literature published by your trailer or hitch manufacturer for more details.

#### **WARNING**

***Make sure the safety chain is securely attached to both the trailer and the vehicle prior to departure:***

*Towing a trailer without using a safety chain securely attached to both the trailer and the vehicle is dangerous. If damage occurs to the coupling unit or hitch ball, the trailer could wander into another lane and cause a collision.*

### ▼ Trailer Lights

Trailer lights must comply with all federal, state, and local regulations. Equip your trailer as required before towing it day or night.

#### **CAUTION**

*Don't connect a trailer lighting system directly to the lighting system of your Mazda. This may damage your vehicle's electrical system and lighting systems. Have a recreational vehicle dealer or trailer rental agency connect the system, and inspect the brake lights and turn signals yourself before each trip.*

### ▼ Trailer Brakes

If the total trailer weight exceeds 450 kg (1,000 lb), trailer brakes are required. If your trailer has brakes, make sure they comply with all federal, state, and local regulations.

#### **WARNING**

***Do not connect a hydraulic trailer-brake system to your vehicle's brake system:***

*Connecting a hydraulic trailer-brake system directly to the vehicle brake system is dangerous and will result in inadequate braking and possible injury.*

### ▼ Trailer Towing Tips

- Verify that your Mazda maintains a near-normal attitude when a loaded or unloaded trailer is connected. Don't drive if it has an abnormal front-up or front-down position. Inspect for incorrect tongue load, worn suspension parts, and trailer overloading.
- Make sure the trailer is properly loaded and the cargo is secure to prevent it from shifting.
- Make sure the mirrors conform to all government regulations. If they do not, install required rear view mirrors appropriate for towing purposes.

Before Driving Your Mazda  
**Towing**

The three main causes of vehicle-trailer accidents are driver error, excessive speed, and improper trailer loading.

**Before driving**

- Have your cooling and braking system checked by an Authorized Mazda Dealer.
- Before starting out, inspect the operation of all vehicle and trailer lights and all vehicle-to-trailer connections. Stop and re-inspect all lights and connections after driving a short distance.

**Driving**

- Your Mazda will handle differently with a trailer in tow, so practice turning, backing, and stopping in a traffic-free area.
- Take time to get accustomed to the extra weight and length.
- Allow more room between your vehicle and the one in front because braking distance increases with a trailer. For each 16 km/h (10 mph) of speed, allow at least one vehicle and trailer length between your Mazda and the vehicle ahead.
- Avoid jerky starts or sudden acceleration.
- Avoid sudden braking. It may cause loss of control and result in jackknifing, especially so on wet or slippery roads.
- Shift the shift lever to the D position when towing a trailer in hilly terrain or when heavily loaded.

These positions will allow operating the vehicle without frequent shifting.

**Lane changes and turning**

Avoid quick lane changes, sudden turns, and tight turns. Slow down before turning to avoid the need of sudden braking.

A turning trailer will make a tighter arc than the tow vehicle. Compensate with turns that are larger than normal.

**Passing**

Plan well ahead to pass other vehicles, and provide plenty of room before changing lanes. Crosswinds from passing vehicles, especially larger ones, and the effects of rough roads will affect handling.

If swaying occurs, firmly grip the steering wheel and reduce speed immediately, but gradually.

Steer straight ahead. If no extreme correction of steering or braking is made, the combination of less speed and firm steering will result in stability.

**Backing up**

Backing a vehicle with a trailer requires practice and patience. Back slowly, and have a helper outside at the rear of the trailer to reduce the risk of an accident.

To turn the trailer, place your hand at the bottom of the steering wheel and turn it in the direction you want the trailer to go. Make only slight movements to prevent sharp or prolonged turning.

Before Driving Your Mazda

## **Towing**

---

### **Ascending a hill**

Shift into a lower gear to reduce the possibility of overloading or overheating the engine, or both.

### **Descending a hill**

Shift into a lower gear and use engine compression as a braking effect.

### **WARNING**

#### ***Always use lower gears to reduce speed:***

*Holding the brake pedal down too long or too frequently is dangerous as it could cause the brakes to overheat and lose power, resulting in loss of control and a serious accident. Use lower gears to help reduce speed. Pull off the road and allow brakes to cool down whenever braking performance feels reduced.*

### **Overheated engine**

The extra weight of the trailer may strain the engine on hot days and on long or steep upgrades.

If the temperature gauge indicates overheating, turn off the air conditioner, drive safely to the side of the road, park off the right-of-way and wait for engine to cool. Refer to Overheating (page 7-11).

### **Parking**

Always make sure the tires of the trailer and the tow vehicle are blocked while parked. Apply the parking brake firmly and put the transaxle in P.

#### **Avoid parking on an incline, but if you must, follow these instructions:**

1. Depress and hold down the brake pedal.
2. Have a helper put wheel blocks against the downhill side of all vehicle and trailer tires.
3. Then release the brake pedal slowly until the blocks bear the load.
  - If the grade is downhill, turn the steering wheel so that the front of the front tires face the curb.
  - If it is uphill, face the rear of the front tires against the curb.
4. Firmly apply the parking brake.
5. Shift the transaxle into P, and stop the engine.

#### **To restart after parking on an incline:**

1. With the transaxle in P, start the engine. (Be sure to depress and hold the brake pedal.)
2. Shift into gear.



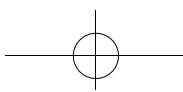

Before Driving Your Mazda

## Towing

---

3. Release the parking brake (also the foot brake) and pull away from the wheel blocks.  
Stop; apply the parking brake and shift into P.
4. Have a helper retrieve the wheel blocks.

### **Fuel consumption**

Trailer towing causes higher fuel consumption.

### **Maintenance**

If you tow a trailer frequently, have your vehicle serviced as shown in Scheduled Maintenance (page 8-3).

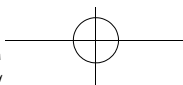
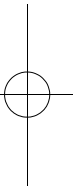
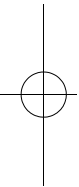

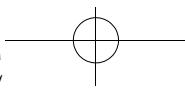
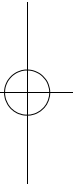
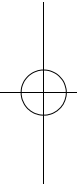
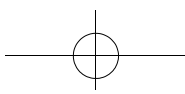

# 5 Driving Your Mazda

Explanation of instruments and controls.

<b>Starting and Driving .....</b>	<b>5-2</b>
Ignition Switch .....	5-2
Starting the Engine .....	5-4
Brake System .....	5-5
Automatic Transaxle Controls .....	5-10
Power Steering .....	5-16
All-Wheel Drive (AWD) Operation * .....	5-16
Cruise Control .....	5-19
Traction Control System (TCS) .....	5-22
Dynamic Stability Control (DSC) .....	5-25
Tire Pressure Monitoring System * .....	5-27
<b>Instrument Cluster and Indicators .....</b>	<b>5-33</b>
Meters and Gauges .....	5-33
<b>Warning/Indicator Lights and Beep Sounds .....</b>	<b>5-38</b>
Warning/Indicator Lights .....	5-38
Beep Sounds .....	5-52
<b>Switches and Controls .....</b>	<b>5-53</b>
Lighting Control .....	5-53
Turn and Lane-Change Signals .....	5-56
Fog Lights * .....	5-56
Windshield Wipers and Washer .....	5-57
Rear Window Wiper and Washer .....	5-58
Rear Window Defroster .....	5-59
Horn .....	5-60
Hazard Warning Flasher .....	5-60

\*Some models. **5-1**

Driving Your Mazda

## Starting and Driving

### Ignition Switch

#### Auxiliary key (with advanced key)

#### NOTE

When starting the engine using the advanced key, refer to *Starting the Engine* (page 3-9).

When starting the engine with the auxiliary key, perform the following procedure.

1. Remove the auxiliary key from the advanced key (page 3-15).
2. Make sure the start knob is in LOCK position.
3. Remove the start knob by pulling it outward while pressing the buttons on both the left and right sides.

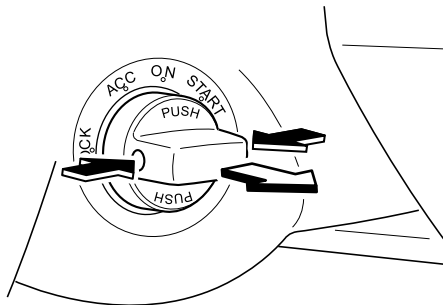

4. Insert the auxiliary key in the ignition switch.

#### ▼ Ignition Switch Positions

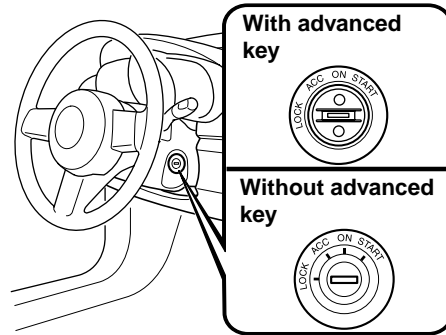

#### **LOCK**

The steering wheel locks to protect against theft. Only in this position can the key be removed.

Driving Your Mazda  
**Starting and Driving**

**⚠ WARNING**

**Remove the key only when the vehicle is parked:**

*Removing the key from the ignition switch while the vehicle is moving is dangerous. Removing the key allows the steering wheel to lock. You will lose steering control and a serious accident could occur. (For vehicles equipped with the advanced key, the steering wheel locks when the starter knob is turned to the LOCK position.)*

**Before leaving the driver's seat, always put the key or start knob to LOCK position, set the parking brake and make sure the shift lever is in P:**

*Intentionally placing the key or start knob into LOCK position is much more important where you will not be removing the key to leave the vehicle and because leaving it in other positions will disable some of the vehicle security systems and run the battery down.*

*Leaving the driver's seat without putting the ignition switch in LOCK position, setting the parking brake and the shift lever is in P is dangerous. Unexpected vehicle movement could occur. This could cause an accident.*

**NOTE**

*If turning the key is difficult, jiggle the steering wheel from side to side.*

*Leaving the key or start knob in any position but LOCK position also disables some of the security features and may run the battery down.*

**ACC (Accessory)**

The steering wheel unlocks and some electrical accessories will operate.

**ON**

This is the normal running position after the engine is started. The warning lights (except brakes) should be inspected before the engine is started (page 5-38).

**NOTE**

*When the ignition switch is turned to the ON position, the sound of the fuel pump motor operating near the fuel tank can be heard. This does not indicate an abnormality.*

**START**

The engine is started in this position. It will crank until you release the key; then it returns to the ON position. The brake warning light can be checked after the engine is started (page 5-38).

**▼ Ignition Key Reminder**

If the ignition switch is in the LOCK or ACC position with the key inserted, a continuous beep sound will be heard when the driver's door is opened.

Driving Your Mazda

## Starting and Driving

### Starting the Engine

#### **NOTE**

*Engine-starting is controlled by the spark ignition system.*

*This system meets all Canadian Interference-Causing Equipment Standard requirements regulating the impulse electrical field strength of radio noise.*

1. Occupants should fasten their seat belts.
2. Make sure the parking brake is on.
3. Depress the brake pedal.
4. Put the vehicle in park (P). If you must restart the engine while the vehicle is moving, shift into neutral (N).

#### **NOTE**

*The starter will not operate if the shift lever is **not** in P or N.*

5. Turn the ignition switch to the START position and hold (up to 10 seconds at a time) until the engine starts.

#### **CAUTION**

*Don't try the starter for more than 10 seconds at a time. If the engine stalls or fails to start, wait 10 seconds before trying again. Otherwise, you may damage the starter and drain the battery.*

6. After starting the engine, let it idle for about 10 seconds.

#### **NOTE**

- *In extremely cold weather or after the vehicle has not been driven in several days, let the engine warm up without operating the accelerator.*
- *Whether the engine is cold or warm, it should be started without use of the accelerator.*

## Starting and Driving

### Brake System

#### ▼ Foot Brake

Your Mazda has power-assisted brakes that adjust automatically through normal use.

Should power-assist fail, you can stop by applying greater force than normal to the brake pedal. But the distance required to stop will be greater than usual.

#### **⚠ WARNING**

**Do not coast with the engine stalled or turned off, find a safe place to stop:**

*Coasting with the engine stalled or turned off is dangerous. Braking will require more effort, and the brake's power-assist could be depleted if you pump the brake. This will cause longer stopping distances or even an accident.*

**Shift to a lower gear when going down steep hills:**

*Driving with your foot continuously on the brake pedal or steadily applying the brakes for long distances is dangerous. This causes overheated brakes, resulting in longer stopping distances or even total brake failure. This could cause loss of vehicle control and a serious accident. Avoid continuous application of the brakes.*

#### **⚠ WARNING**

**Dry brakes that have become wet by driving very slowly and applying the brakes lightly until brake performance is normal:**

*Driving with wet brakes is dangerous. Increased stopping distance or the vehicle pulling to one side when braking could result in a serious accident. Light braking will indicate whether the brakes have been affected.*

#### ▼ Parking Brake

#### **⚠ WARNING**

**Before leaving the driver's seat, always put the key or start knob to LOCK position, set the parking brake and make sure the shift lever is in P:**

*Intentionally placing the key or start knob into LOCK position is much more important where you will not be removing the key to leave the vehicle and because leaving it in other positions will disable some of the vehicle security systems and run the battery down.*

*Leaving the driver's seat without putting the ignition switch in LOCK position, setting the parking brake and the shift lever is in P is dangerous. Unexpected vehicle movement could occur. This could cause an accident.*

#### **⚠ CAUTION**

*Driving with the parking brake on will cause excessive wear of the brake linings or pads.*

Driving Your Mazda

## Starting and Driving

### **NOTE**

For parking in snow, refer to *Winter Driving* (page 4-8) regarding parking brake use.

### **Setting the parking brake**

Depress the brake pedal, then depress the parking brake pedal fully.

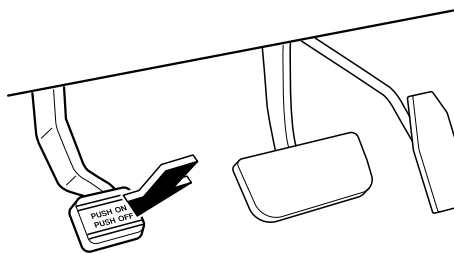

### **Releasing the parking brake**

Depress the brake pedal, then depress the parking brake pedal until it releases. Gradually let up on the parking brake pedal.

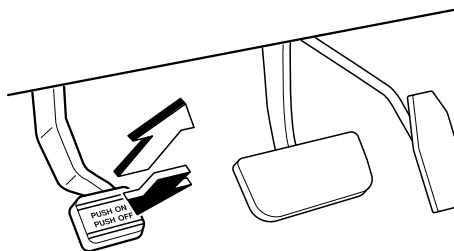

### **NOTE**

Release the parking brake pedal once before trying to reapply it.

### **▼ Brake System Warning Light**



This warning has the following functions:

#### **Parking brake warning**

The light comes on when the parking brake is applied with the ignition switch in the START or ON position. It goes off when the parking brake is fully released.

#### **Low brake fluid level warning**

If the light stays on after the parking brake is fully released, you may have a brake problem.

Drive to the side of the road and park off the right-of-way.

You may notice that the pedal is harder to push or that it may go closer to the floor. In either case, it will take longer to stop the vehicle.

1. With the engine stopped, check the brake fluid level immediately and add fluid as required (page 8-23).
2. After adding fluid, check the light again.

If the warning light remains on, or if the brakes do not operate properly, do not drive the vehicle. Have it towed to an Authorized Mazda Dealer.

Even if the light goes out have your brake system inspected as soon as possible by an Authorized Mazda Dealer.



## Starting and Driving

### NOTE

Having to add brake fluid is sometimes an indicator of leakage. Consult an Authorized Mazda Dealer as soon as possible even if the brake light is no longer illuminated.

### WARNING

**Do not drive with the brake system warning light illuminated. Contact an Authorized Mazda Dealer to have the brakes inspected as soon as possible:**

*Driving with the brake system warning light illuminated is dangerous. It indicates that your brakes may not work at all or that they could completely fail at any time. If this light remains illuminated, after checking that the parking brake is fully released, have the brakes inspected immediately.*

### ▼ Parking Brake Reminder

If the parking brake has not been completely released and the vehicle is driven at about 5 km/h (3 mph) or faster, a continuous beep sound will be heard to notify the driver that the parking brake has not been released.

### ▼ Anti-Lock Brake System (ABS)

The ABS control unit continuously monitors the speed of each wheel. If one is about to lock up, the ABS responds by automatically releasing and reapplying that wheel's brake.

The driver will feel a slight vibration in the brake pedal and may hear a chattering noise from the brake system. This is normal when the ABS operates. Don't pump the brakes, continue to press down on the brake pedal.

### WARNING

**Do not rely on ABS as a substitute for safe driving:**

*The ABS cannot compensate for unsafe and reckless driving, excessive speed, tailgating (following another vehicle too closely), driving on ice and snow, and hydroplaning (reduced tire friction and road contact because of water on the road surface). You can still have an accident.*

### NOTE

- *Braking distances may be longer on loose surfaces (snow or gravel, for example) which usually have a hard foundation. A vehicle with a normal braking system may require less distance to stop under these conditions because the tires will build up a wedge of surface layer when the wheels skid.*
- *The sound of the ABS operating may be heard when starting the engine or immediately after starting the vehicle. However, it does not indicate a malfunction.*

### ▼ ABS Warning Light



The warning light stays on for a few seconds when the ignition switch is turned to the ON position.

Driving Your Mazda

## Starting and Driving

If the ABS warning light stays on while you're driving, the ABS control unit has detected a system malfunction. If this occurs, your brakes will function normally as if the vehicle had no ABS. Should this happen, consult an Authorized Mazda Dealer as soon as possible.

### NOTE

*When the engine is jump-started to charge the battery, uneven rpm occurs and the ABS warning light comes on. This is due to a weak battery, not a malfunction. Recharge the battery.*

### ▼ Electronic Brake Force Distribution System Warning



If the electronic brake force distribution control unit determines that some components are operating incorrectly, the control unit may turn the brake system warning light and the ABS warning light on at the same time. The problem is likely to be the electronic brake force distribution system.

### ⚠ WARNING

**Do not drive with both the ABS warning light and brake warning light illuminated. Have the vehicle towed to an Authorized Mazda Dealer to have the brakes inspected as soon as possible:**

*Driving when the brake system warning light and ABS warning light are illuminated at the same time is dangerous.*

*When both lights are illuminated, the rear wheels could lock more quickly in an emergency stop than under normal circumstances.*

### ▼ Brake Assist

During emergency braking situations when it is necessary to depress the brake pedal with greater force, the brake assist system provides braking assistance, thus enhancing braking performance.

When the brake pedal is depressed hard or depressed more quickly, the brakes apply more firmly.

### NOTE

- *When the brake pedal is depressed hard or depressed more quickly, the pedal will feel softer but the brakes will apply more firmly. This is a normal effect of the brake assist operation and does not indicate an abnormality.*
- *When the brake pedal is depressed hard or depressed more quickly, a clicking noise from the brake booster may be heard. This is a normal effect of the brake assist and does not indicate an abnormality.*
- *The brake assist equipment does not supersede the functionality of the vehicle's main braking system.*

Driving Your Mazda  
**Starting and Driving**

▼ **Brake Pad Wear Indicator**

When the disc brake pads become worn, the built-in wear indicators contact the disc plates. This causes a screeching noise to warn that the pads should be replaced.

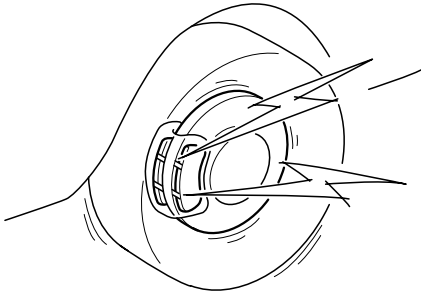

When you hear this noise, consult an Authorized Mazda Dealer as soon as possible.

**! WARNING**

***Do not drive with worn disc pads:***  
*Driving with worn disc pads is dangerous. The brakes could fail and cause a serious accident. As soon as you hear a screeching noise consult an Authorized Mazda Dealer.*

Driving Your Mazda

## Starting and Driving

### Automatic Transaxle Controls

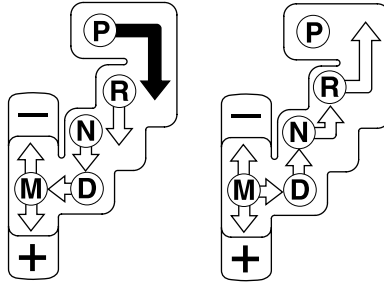
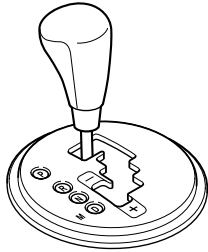

#### Various Lockouts:



Indicates that you must depress the brake pedal to shift (The ignition switch must be in the ACC or ON position).



Indicates the shift lever can be shifted freely into any position.

#### **NOTE**

*This Sport AT has an option that is not included in traditional automatic transaxle - giving the driver the option of selecting each gear instead of leaving it to the transaxle to shift gears. Even if you intend to use the automatic transaxle functions as a traditional automatic, you should also be aware that you can inadvertently shift into manual shift mode and an inappropriate gear may be retained as you change speeds. If you notice the engine speed going higher or hear the engine racing, confirm you have not accidentally slipped into manual shift mode (page 5-12).*

## Starting and Driving

### ▼ Transaxle Ranges

The shift lever must be in P or N to operate the starter.

#### **P (Park)**

P locks the transaxle and prevents the front wheels from rotating.

#### **! WARNING**

**Always set the shift lever to P and set the parking brake:**

*Only setting the shift lever to the P position without using the parking brake to hold the vehicle is dangerous. If P fails to hold, the vehicle could move and cause an accident.*

#### **! CAUTION**

- *Shifting into P, N or R while the vehicle is moving can damage your transaxle.*
- *Shifting into a driving gear or reverse when the engine is running faster than idle can damage the transaxle.*

#### **R (Reverse)**

In position R, the vehicle moves only backward. You must be at a complete stop before shifting to or from R, except under rare circumstances as explained in Rocking the Vehicle (page 4-8).

#### **N (Neutral)**

In N, the wheels and transaxle are not locked. The vehicle will roll freely even on the slightest incline unless the parking brake or brakes are on.

#### **! WARNING**

***If the engine is running faster than idle, do not shift from N or P into a driving gear:***

*It's dangerous to shift from N or P into a driving gear when the engine is running faster than idle. If this is done, the vehicle could move suddenly, causing an accident or serious injury.*

***Do not shift into N when driving the vehicle:***

*Shifting into N while driving is dangerous. Engine braking cannot be applied when decelerating which could lead to an accident or serious injury.*

#### **! CAUTION**

***Do not shift into N when driving the vehicle. Doing so can cause transaxle damage.***

#### ***NOTE***

*Apply the parking brake or depress the brake pedal before moving the shift lever from N to prevent the vehicle from moving unexpectedly.*

#### **D (Drive)**

D is the normal driving position. From a stop, the transaxle will automatically shift through a 6-gear sequence.

#### **M (Manual)**

M is the manual shift mode position. Gears can be shifted up or down by operating the shift lever. Refer to Manual Shift Mode (page 5-12).

Driving Your Mazda

## Starting and Driving

### ▼ Active Adaptive Shift (AAS)

Active Adaptive Shift (AAS) automatically controls the transaxle shift points to best suit the road conditions and driver input. This optimizes engine performance and improves driving comfort. When cornering the vehicle, AAS mode will hold the transaxle in the gear the vehicle was in before entering the curve, allowing the vehicle to be accelerated from the same gear after exiting the curve.

If the driver accelerates rapidly, or accelerates and decelerates rapidly by operating the accelerator and brake pedal for a certain period of time while the selector lever is in the D position, AAS mode could activate. When this occurs, AAS mode will maintain the transaxle in the optimum gear and the driver may sense that the transaxle is not shifting, however this does not indicate an abnormality.

### ▼ Shift-Lock System

**The shift-lock system prevents shifting out of P unless the brake pedal is depressed.**

To shift from P:

1. Depress and hold the brake pedal.
2. Start the engine.
3. Move the shift lever.

### NOTE

- When the ignition switch is in the LOCK position, the shift lever cannot be shifted from P.
- To be sure the vehicle is in park, **the ignition key cannot be removed unless the shift lever is in P.**
- **(With Advanced Key)**  
The ignition switch cannot be turned from the ACC position to the LOCK position when the shift lever is not in P.

### ▼ Manual Shift Mode

This mode gives you the feel of driving a manual transaxle vehicle by operating the shift lever and allows you to control engine rpm and torque to the front wheels much like a manual transaxle when more control is desired.

To change to manual shift mode, shift the lever from D to M.

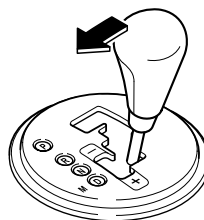

To return to automatic shift mode, shift the lever from M to D.

### NOTE

*If you change to manual shift mode when the vehicle is stopped, the gear will shift to M1.*

## Driving Your Mazda Starting and Driving

### **Indicators**

#### **Shift position indicator**

In manual shift mode, the “M” of the shift position indicator in the instrument panel illuminates.

#### **Gear position indicator**

The numeral for the selected gear illuminates.

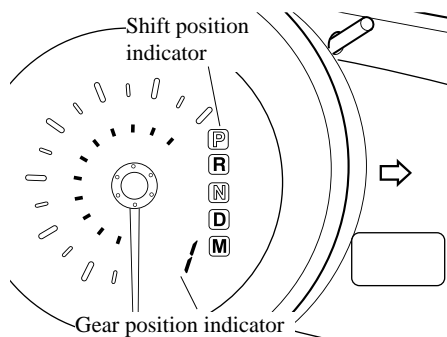

#### **NOTE**

*If the gears cannot be shifted down when driving at higher speeds, the gear position indicator will flash twice to signal that the gears cannot be shifted down.*

### **Shifting**

#### **Manually Shifting up**

**(M1→M2→M3→M4→M5→M6)**

To shift up to a higher gear, tap the shift lever back (+) once.

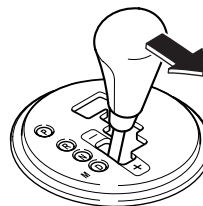

#### **NOTE**

- *When driving slowly, the gears may not shift up depending on vehicle speed.*
- *In manual shift mode, gears do not shift up automatically. Don't run the engine with the tachometer needle in the RED ZONE. If the tachometer needle enters the RED ZONE, you may feel engine-braking because the fuel delivery will be stopped to protect the engine. However, this does not indicate an abnormality.*
- *When depressing the accelerator fully, the transaxle will shift to a lower gear, depending on vehicle speed.*

Driving Your Mazda

## Starting and Driving

### Manually Shifting down

(M6→M5→M4→M3→M2→M1)

To shift down to a lower gear, tap the shift lever forward (–) once.

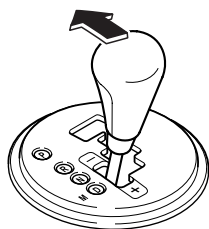

### **⚠ WARNING**

**Do not use engine braking on slippery road surfaces or at high speeds:**

*Shifting down while driving on wet, snowy, or frozen roads, or while driving at high speeds causes sudden engine braking, which is dangerous. The sudden change in tire speed could cause the tires to skid. This could lead to loss of vehicle control and an accident.*

### NOTE

- When driving at high speeds, the gear may not shift down depending on vehicle speed.
- During deceleration, the gear may automatically shift down depending on vehicle speed.
- When depressing the accelerator fully, the transaxle will shift to a lower gear, depending on vehicle speed.

### Second gear fixed mode

When the shift lever is tapped back (+) while the vehicle is stopped, the transaxle is set in the second gear fixed mode. The gear is fixed in second while in this mode for easier starting and driving on slippery roads. If the shift lever is tapped back (+) or forward (–) while in the second gear fixed mode, the mode will be canceled.

### Shifting specification

#### Shifting up

If the vehicle speed is lower than the speed specified for each gear, the gear cannot be shifted up to a higher gear.

Gear	Vehicle speed
M1→M2	You can shift up to M2 whether the vehicle is stopped or moving.
M2→M3	9 km/h (6 mph)
M3→M4	26 km/h (16 mph)
M4→M5	36 km/h (22 mph)
M5→M6	53 km/h (33 mph)

#### Shifting down

If the vehicle speed is higher than the speed specified for each gear, the gear cannot be shifted down to a lower gear.

Gear	Vehicle speed
M6→M5	230 km/h (143 mph)
M5→M4	182 km/h (113 mph)
M4→M3	135 km/h (83 mph)
M3→M2	86 km/h (53 mph)
M2→M1	44 km/h (27 mph)

During deceleration, the gears shift down automatically when speed is reduced to the following:

Gear	Vehicle speed
M6→M5	52 km/h (32 mph)
M5→M4	34 km/h (21 mph)
M4→M3	25 km/h (15 mph)
M3 or M2→M1	8 km/h (5 mph)



Driving Your Mazda  
**Starting and Driving**

**NOTE**

*The gear does not shift down to M1 automatically while in the second gear fixed mode.*

If the vehicle is kicked down at the following speeds or lower, the gears shift down automatically:

Gear	Vehicle speed
M6→M5	220 km/h (136 mph)
M5→M4	50 km/h (31 mph)
M4→M3	30 km/h (18 mph)
M3 or M2→M1	8 km/h (5 mph)

**Recommendations for shifting**

**Upshifting**

For normal acceleration and cruising, we recommend these shift points.

Gear	Vehicle speed
M1 to M2	24 km/h (15 mph)
M2 to M3	40 km/h (25 mph)
M3 to M4	65 km/h (40 mph)
M4 to M5	73 km/h (45 mph)
M5 to M6	80 km/h (50 mph)

**Downshifting**

When you must slow down in heavy traffic or on a steep **upgrade**, downshift before the engine starts to overwork. This gives better acceleration when you need more speed.

On a steep **downgrade**, downshifting helps maintain safe speed and prolongs brake life.

**▼ Driving Tips**

**Passing**

For extra power when passing another vehicle or climbing steep grades, depress the accelerator fully. The transaxle will shift to a lower gear, depending on vehicle speed.

**Climbing steep grades from a stop**

To climb a steep grade from a stopped position:

1. Depress the brake pedal.
2. Shift to D or M1, depending on the load weight and grade steepness.
3. Release the brake pedal while gradually accelerating.

**Descending steep grades**

When descending a steep grade, shift to lower gears, depending on load weight and grade steepness. Descend slowly, using the brakes only occasionally to prevent them from overheating.

Driving Your Mazda

## Starting and Driving

### Power Steering

Power steering is only operable when the engine is running. If the engine is off or if the power steering system is inoperable, you can still steer, but it requires more physical effort.

If the steering feels stiffer than usual during normal driving, consult an Authorized Mazda Dealer.

#### CAUTION

*Never hold the steering wheel to the extreme left or right for more than 5 seconds with the engine running. This could damage the power steering system.*

### All-Wheel Drive (AWD) Operation \*

AWD provides excellent driveability on snow-covered and ice-packed roads, sand and mud, as well as on steep slopes and other slippery surfaces.

Driving Your Mazda  
**Starting and Driving**

▼ AWD Driving

**! WARNING**

**Avoid sharp turns, excessive speed and abrupt maneuvers when driving this vehicle:**

*Sharp turns, excessive speed and abrupt maneuvering of this vehicle is dangerous as it could result in the increased risk of loss of vehicle control, vehicle roll-over, personal injury or death.*

*This vehicle has a higher center of gravity. Vehicles with a higher center of gravity such as utility and AWD vehicles handle differently than vehicles with a lower center of gravity.*

*Utility and AWD vehicles are not designed for cornering at speeds as any more than low profile sports cars are designed to perform satisfactorily under off-road conditions. In addition, utility vehicles have a significantly higher rollover rate than other types of vehicles.*

*RSC might help if you get into trouble, but then it might not be able to allow you to fully recover, always drive carefully with the vehicle's height in mind.*

**Drive carefully when the vehicle is loaded by lowering vehicle speed and applying the brakes earlier:**

*Abrupt maneuvering and sudden braking when driving a loaded vehicle is dangerous as the driving behavior of a vehicle with a high center of gravity is different when it is loaded compared to when it is not, and could result in the loss of vehicle control and an accident.*

▼ AWD Warning Light

# 4WD

This warning light stays on for a few seconds when the ignition switch is turned to the ON position.

Thereafter, the warning light will illuminate or flash under the following conditions:

- Illuminates when there is an abnormality with the AWD system.
- Flashes when the differential oil temperature is abnormally high.
- Flashes when there are continually large differences between front and rear wheel rotation, such as when trying to pull away from an icy surface.

**If the AWD warning light illuminates:**

If the AWD warning light illuminates, contact an Authorized Mazda Dealer.

**If the AWD warning light flashes:**

Park the vehicle in a safe place. After a few moments; if the warning light stops flashing, you can resume driving. If the light does not stop flashing, contact an Authorized Mazda Dealer.

Driving Your Mazda

## Starting and Driving

### **WARNING**

**Never spin a wheel that is off the ground:**

*Spinning a wheel that is off the ground as a result of the vehicle being stuck or in a ditch is dangerous. The drive assembly could be seriously damaged which could lead to an accident or could even lead to overheating, oil leakage, and a fire.*

### ▼ **Tires and Tire Chains**

The condition of the tires plays a large role in the performance of the vehicle. Moreover, to prevent adverse effects to the drive assembly, please note the following:

#### **Tires**

- When replacing tires, always replace all front and rear tires at the same time.
- All tires must be of the same size, manufacture, brand and tread pattern. Pay particular attention when equipping snow or other types of winter tires.
- Do not mix tread-worn tires with normal tires.
- Inspect tire inflation pressures at the specified periods and adjust to the specified pressures.

#### ***NOTE***

*Check the tire inflation pressure label attached to driver's door frame for the correct tire inflation pressure.*

- Make sure to equip the vehicle with genuine wheels of the specified size, on all wheels. With AWD, the system is calibrated for all four wheels being of the same dimensions.

### **Tire chains**

- Install tire chains to the front tires.
- Do not use tire chains on the rear wheels.
- Do not drive the vehicle faster than 30 km/h (19 mph) with the tire chains installed.
- Do not drive the vehicle with tire chains on road conditions other than snow or ice.

### ▼ **Towing**

If the vehicle requires towing, have it towed with all four wheels completely off the ground(page 7-18).

Driving Your Mazda  
**Starting and Driving**

## Cruise Control

With cruise control, you can set and automatically maintain any speed of more than about 30 km/h (19 mph).

### **⚠ WARNING**

**Do not use the cruise control under the following conditions:**

*Using the cruise control under the following conditions is dangerous and could result in loss of vehicle control.*

- Hilly terrain
- Steep inclines
- Heavy or unsteady traffic
- Slippery or winding roads
- Similar restrictions that require inconsistent speed

### ▼ **Cruise Main Indicator Light (Amber)/Cruise Set Indicator Light (Green)**

# CRUISE

The indicator light has two colors.

#### **Cruise Main Indicator Light (Amber)**

The indicator light illuminates amber when the ON/OFF switch is pressed and the cruise control system is activated.

#### **Cruise Set Indicator Light (Green)**

The indicator light illuminates green when a cruising speed has been set.

### ▼ **Activation/Deactivation**

To activate the system, press the ON/OFF switch.

The cruise main indicator light illuminates.

To deactivate the system, press the switch again.

The cruise main indicator light turns off.

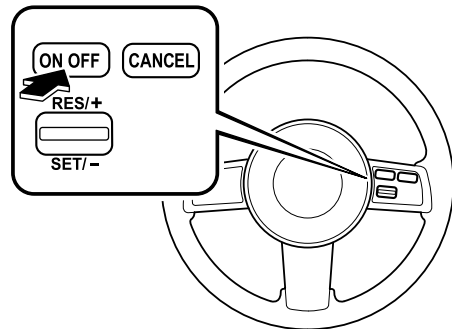

### **⚠ WARNING**

**Keep the ON/OFF switch off when cruise control is not in use:**

*Leaving the ON/OFF switch on when not using the cruise control is dangerous as you may hit one of the other buttons and put the vehicle in cruise control unexpectedly. This could result in loss of vehicle control.*

### ▼ **To Set Speed**

1. Activate the cruise control system by pressing the ON/OFF switch.
2. Accelerate to the desired speed, which must be more than 30 km/h (19 mph).

Driving Your Mazda

## Starting and Driving

3. Press down the cruise control switch and release it at the speed you want. Release the accelerator at the same time.

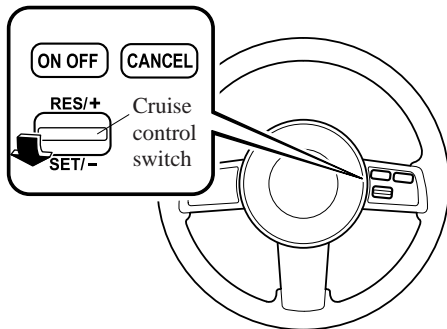

Don't continue to hold the switch. Until you release it, speed will continue to drop (unless you continue to accelerate) and you'll miss the desired speed.

### NOTE

- The SET function can't be activated until about 2 seconds after the ON/OFF switch has been engaged.
- On a steep grade, the vehicle may momentarily slow down going up or speed up while going down.
- Cruise control will turn off if vehicle speed drops below 30 km/h (19 mph) when cruise is activated, such as when climbing a steep grade.

### ▼ To Increase Cruising Speed

Follow either of these procedures.

#### To increase speed using cruise control switch

Pull up the cruise control switch and hold it. Your vehicle will accelerate. Release the switch at the speed you want.

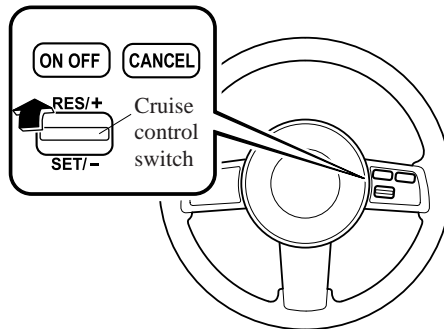

Your vehicle has a tap-up feature that allows you to increase your current speed in increments of 1.6 km/h (1 mph) by a momentary tap of the cruise control switch. Multiple taps will increase your vehicle speed 1.6 km/h (1 mph) for each tap.

## Driving Your Mazda Starting and Driving

### **To increase speed using accelerator pedal**

Depress the accelerator pedal to accelerate to the desired speed.  
press down the cruise control switch and release it immediately.

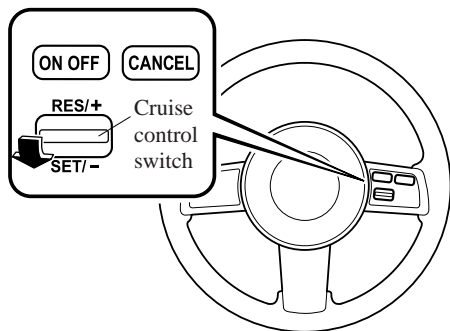

### **NOTE**

*Accelerate if you want to speed up temporarily when the cruise control is on. Greater speed will not interfere with or change the set speed. Take your foot off the accelerator to return to the set speed.*

### **▼ To Decrease Cruising Speed**

Press down the cruise control switch and hold it. The vehicle will gradually slow. Release the switch at the speed you want.

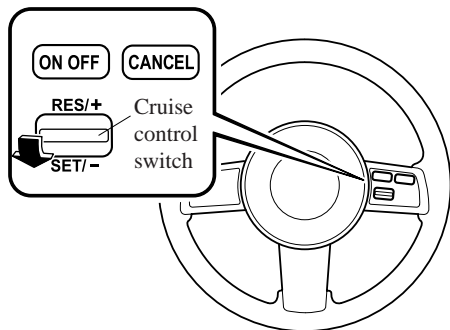

Your vehicle has a tap-down feature that allows you to decrease your current speed in decrements of 1.6 km/h (1 mph) by a momentary tap of the cruise control switch. Multiple taps will decrease your vehicle speed 1.6 km/h (1 mph) for each tap.

### **▼ To Resume Cruising Speed at More Than 30 km/h (19 mph)**

If some other method besides the ON/OFF switch was used to cancel cruising speed (such as applying the brake pedal) and the system is still activated, the most recent set speed will automatically resume when the cruise control switch pulled up. If vehicle speed is below 30 km/h (19 mph), increase the vehicle speed up to 30 km/h (19 mph) and pull up the cruise control switch.

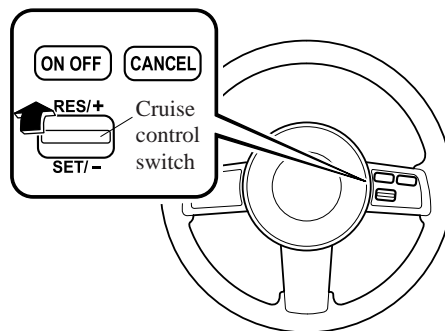

### **▼ To Cancel**

To cancel the system, use **one** of these methods:

- Press the ON/OFF switch.
- Slightly depress the brake pedal.

Driving Your Mazda

## Starting and Driving

- Press the CANCEL button.

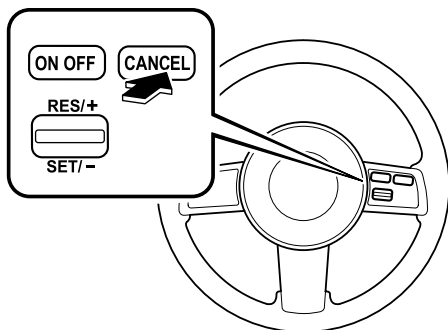

The system is off when the ignition is off.

### NOTE

Cruise control will cancel at about 15 km/h (9 mph) below the preset speed (such as may happen when climbing a long, steep grade) or below 30 km/h (19 mph).

## Traction Control System (TCS)

The Traction Control System (TCS) enhances traction and safety by controlling engine torque. When the TCS detects driving wheel slippage, it lowers engine torque to prevent loss of traction.

This means that on a slick surface, the engine adjusts automatically to provide optimum power to the drive wheels without causing them to spin and lose traction.

### ! WARNING

**Do not rely on the traction control system as a substitute for safe driving:**

*The traction control system (TCS) cannot compensate for unsafe and reckless driving, excessive speed, tailgating (following another vehicle too closely), and hydroplaning (reduced tire friction and road contact because of water on the road surface). You can still have an accident.*

**Use snow tires or tire chains on the front wheels only and drive at reduced speeds when roads are covered with ice and/or snow:**

*Driving without proper traction devices on snow and/or ice-covered roads is dangerous. The traction control system (TCS) alone cannot provide adequate traction and you could still have an accident.*



Driving Your Mazda  
**Starting and Driving**

▼ **TCS/DSC Indicator Light**



This indicator light stays on for a few seconds when the ignition switch is turned to the ON position. If the TCS or DSC is operating, the indicator light flashes.

If the light stays on, the TCS or DSC may have a malfunction and they may not operate correctly. Take your vehicle to an Authorized Mazda Dealer.

**NOTE**

- *In addition to the indicator light flashing, a slight lugging sound will come from the engine. This indicates that the TCS is operating properly.*
- *On slippery surfaces, such as fresh snow, it will be impossible to achieve high rpm when the TCS is on.*

▼ **TCS OFF Indicator Light**

**TCS  
OFF**

This indicator light stays on for a few seconds when the ignition switch is turned to the ON position.

It also illuminates when the TCS OFF switch is pressed and TCS is switched off. Refer to TCS OFF Switch on page 5-24. If the light remains illuminated and the TCS is not switched off, take your vehicle to an Authorized Mazda Dealer. The dynamic stability control may have a malfunction.

Driving Your Mazda

## Starting and Driving

### NOTE

*If the battery is disconnected or a fuse is replaced, the DSC will be inoperable. When this happens, the TCS OFF indicator light flashes and the TCS/DSC indicator light illuminates.*

*To reactivate the DSC, perform the following procedure with the battery connected.*

1. Turn the ignition switch to the ON position.
2. Turn the steering clockwise fully, then turn it counterclockwise fully.
3. Make sure the TCS OFF indicator turns off.
4. Turn the ignition switch to the OFF position, then turn it to the ON position again.
5. Make sure the TCS/DSC indicator light turns off.

*If the TCS/DSC indicator light and the TCS OFF indicator light remain illuminated even after turning the ignition switch to the ON position, attempt the procedure again. If this still does not work, consult an Authorized Mazda Dealer.*

### ▼ TCS OFF Switch

If the vehicle speed is less than 30 km/h (18 mph), press the TCS OFF switch to turn off the TCS. The TCS OFF indicator light will illuminate.

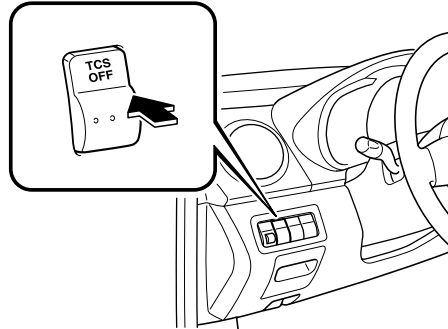

Press the switch again to turn the TCS back on. The TCS OFF indicator light will go out. If the vehicle speed is more than 30 km/h (18 mph), the TCS OFF indicator light will not illuminate even if the switch is pressed.

Driving Your Mazda  
**Starting and Driving**

**NOTE**

- *When TCS is on and you attempt to free the vehicle when it is stuck, or drive it out of freshly fallen snow, the TCS will activate. Depressing the accelerator will not increase engine power and freeing the vehicle may be difficult. When this happens, turn off the TCS.*
- *If the TCS is off when the engine is turned off, it automatically activates when the ignition switch is turned on.*
- *Leaving the TCS on will provide the best traction.*
- *If the TCS is OFF when the vehicle speed is more than 30 km/h (18 mph), it automatically activates and the TCS OFF indicator light will turn off.*
- *If the TCS OFF switch is pressed and held for 10 seconds or more, the TCS OFF switch malfunction detection function operates and the TCS system activates automatically. The TCS OFF indicator light turns off while the TCS system is operative.*

**Dynamic Stability Control (DSC)**

The Dynamic Stability Control (DSC) automatically controls braking and engine torque in conjunction with systems such as ABS and TCS to help control side slip when driving on slippery surfaces, or during sudden or evasive maneuvering, enhancing vehicle safety.

Refer to ABS (page 5-7) and TCS (page 5-22).

DSC operation is possible at speeds greater than 20 km/h (12 mph).

**! WARNING**

**Do not rely on the dynamic stability control as a substitute for safe driving:**  
*The dynamic stability control (DSC) cannot compensate for unsafe and reckless driving, excessive speed, tailgating (following another vehicle too closely), and hydroplaning (reduced tire friction and road contact because of water on the road surface). You can still have an accident.*

Driving Your Mazda

## Starting and Driving

---

### CAUTION

- *The DSC may not operate correctly unless the following are observed:*
  - *Use tires of the correct size specified for your Mazda on all four wheels.*
  - *Use tires of the same manufacturer, brand and tread pattern on all four wheels.*
  - *Do not mix worn tires.*
- *The DSC may not operate correctly when tire chains are used or a temporary spare tire is installed because the tire diameter changes.*

### ▼ TCS/DSC Indicator Light



This indicator light stays on for a few seconds when the ignition switch is turned to the ON position. If the TCS or DSC is operating, the indicator light flashes.

If the light stays on, the TCS or DSC may have a malfunction and they may not operate correctly. Take your vehicle to an Authorized Mazda Dealer.

Driving Your Mazda  
**Starting and Driving**

### Tire Pressure Monitoring System\*

The tire pressure monitoring system (TPMS) monitors the pressure for each tire. If tire pressure is too low in one or more tires, the system will inform the driver via the warning light in the instrument panel and by the warning beep sound.

The tire pressure sensors installed on each wheel send tire pressure data by radio signal to the receiver unit in the vehicle.

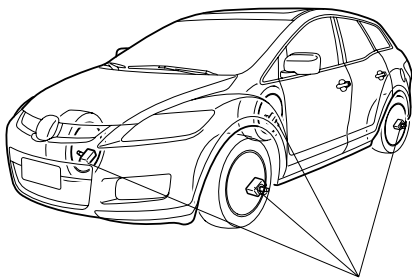

Tire pressure sensors

**NOTE**

*When the ambient temperature is low due to seasonal changes, tire temperatures are also lower. When the tire temperature decreases, the air pressure decreases as well. The TPMS warning light may illuminate more frequently. Visually inspect the tires daily before driving, and check tire pressures monthly with a tire pressure gauge. When checking tire pressures, use of a digital tire pressure gauge is recommended.*

TPMS does not alleviate your need to check the pressure and condition of all four tires regularly.

Driving Your Mazda

## Starting and Driving

---

### CAUTION

- Each tire, including the spare (if provided), should be checked monthly when cold and inflated to the inflation pressure recommended by the vehicle manufacturer on the vehicle placard or tire inflation pressure label. (If your vehicle has tires of a different size than the size indicated on the vehicle placard or tire inflation pressure label, you should determine the proper tire inflation pressure for those tires.)

As an added safety feature, your vehicle has been equipped with a tire pressure monitoring system (TPMS) that illuminates a low tire pressure telltale when one or more of your tires is significantly under-inflated. Accordingly, when the low tire pressure telltale illuminates, you should stop and check your tires as soon as possible, and inflate them to the proper pressure. Driving on a significantly under-inflated tire causes the tire to overheat and can lead to tire failure. Under-inflation also reduces fuel efficiency and tire tread life, and may affect the vehicle's handling and stopping ability.

Please note that the TPMS is not a substitute for proper tire maintenance, and it is the driver's responsibility to maintain correct tire pressure, even if under-inflation has not reached the level to trigger illumination of the TPMS low tire pressure telltale.

- Your vehicle has also been equipped with a TPMS malfunction indicator to indicate when the system is not operating properly. The TPMS malfunction indicator is combined with the low tire pressure telltale. When the system detects a malfunction, the telltale will flash for approximately one minute and then remain continuously illuminated. This sequence will continue upon subsequent vehicle start-ups as long as the malfunction exists. When the malfunction indicator is illuminated, the system may not be able to detect or signal low tire pressure as intended. TPMS malfunctions may occur for a variety of reasons, including the installation of replacement or alternate tires or wheels on the vehicle that prevent the TPMS from functioning properly. Always check the TPMS malfunction telltale after replacing one or more tires or wheels on your vehicle to ensure that the replacement or alternate tires and wheels allow the TPMS to continue to function properly.
- To avoid false readings, the system samples for a little while before indicating a problem. As a result it will not instantaneously register a rapid tire deflation or blow out.

### NOTE

This device complies with part 15 of the FCC Rules. Operation is subject to the following two conditions: (1) This device may not cause harmful interference, and (2) this device must accept any interference received, including interference that may cause undesired operation.

## Starting and Driving

### ▼ Tire Pressure Monitoring System Warning Light



This warning light illuminates for a few seconds when the ignition switch is turned to the ON position.

Thereafter, the warning light illuminates and a beep is heard when tire pressure is too low in one or more tires, and flashes when there is a system malfunction.

### **⚠ WARNING**

*If the tire pressure monitoring system warning light illuminates or flashes, or the tire pressure warning beep sound is heard, decrease vehicle speed immediately and avoid sudden maneuvering and braking:*

*If the tire pressure monitoring system warning light illuminates or flashes, or the tire pressure warning beep sound is heard, it is dangerous to drive the vehicle at high speeds, or perform sudden maneuvering or braking. Vehicle drivability could worsen and result in an accident. To determine if you have a slow leak or a flat, pull over to a safe position where you can check the visual condition of the tire and determine if you have enough air to proceed to a place where air may be added and the system monitored again, an Authorized Mazda Dealer or a tire repair station.*

**Do not ignore the TPMS Warning Light:** *Ignoring the TPMS warning light is dangerous, even if you know why it is illuminated. Have the problem taken care of as soon as possible before it develops into a more serious situation that could lead to tire failure and a dangerous accident.*

### **Warning light illuminates/Warning beep sounds**

When the warning light illuminates, and the warning beep sound is heard (about 3 seconds), tire pressure is too low in one or more tires.

Driving Your Mazda

## Starting and Driving

Adjust the tire pressure to the correct tire pressure. Refer to the specification charts (page 10-6).

### CAUTION

*When replacing/repairing the tires or wheels or both, have the work done by an Authorized Mazda Dealer, or the tire pressure sensors may be damaged.*

### NOTE

- *Perform tire pressure adjustment when the tires are cold. Tire pressure will vary according to the tire temperature, therefore let the vehicle stand for 1 hour or only drive it 1.6 km (1 mile) or less before adjusting the tire pressures. When pressure is adjusted on hot tires to the cold inflation pressure, the TPMS warning light/beep may turn on after the tires cool and pressure drops below specification. Also, an illuminated TPMS warning light, resulting from the tire air pressure dropping due to cold ambient temperature, may go out if the ambient temperature rises. In this case, it will also be necessary to adjust the tire air pressures. If the TPMS warning light illuminates due to a drop in tire air pressure, make sure to check and adjust the tire air pressures.*
- *After adjusting the tire air pressures, it may require some time for the TPMS warning light to go out. If the TPMS warning light remains illuminated, drive the vehicle at a speed of at least 25 km/h (16 mph) for 10 minutes, and then verify that it goes out.*
- *Tires can lose a little air quite naturally over time and the TPMS cannot tell if the tires are getting too soft over time or you have a flat. However, when you find one low tire in a set of four - that is an indication of trouble; you should have someone drive the vehicle slowly forward so you can inspect any low tire for cuts and any metal sticking through tread or sidewall. Put a few drops of water in the valve stem to see if it bubbles indicating a bad valve. Leaks need to be addressed by more than simply refilling the trouble tire as leaks are dangerous - take it to an Authorized Mazda Dealer which has all the equipment to fix tires, TPMS systems and order the best replacement tire for your vehicle.*



Driving Your Mazda  
**Starting and Driving**

If the warning light illuminates again even after the tire pressures are adjusted, there may be a tire puncture. Replace the punctured tire with the temporary spare tire (page 7-6).

**NOTE**

*A tire pressure sensor is not installed to the temporary spare tire. The warning light will flash continuously while the temporary spare tire is being used.*

**Warning light flashes**

When the warning light flashes, there may be a system malfunction. Consult an Authorized Mazda Dealer.

**▼ System Error Activation**

When the TPMS warning light flashes, there may be a system malfunction. Consult an Authorized Mazda Dealer. A system error activation may occur in the following cases:

- When there is equipment or a device near the vehicle using the same radio frequency as that of the tire pressure sensors.
- When using the following devices in the vehicle that may cause radio interference with the receiver unit.
  - A digital device such as a personal computer.
  - A current converter device such as a DC-AC converter.
- When excess snow or ice adheres to the vehicle, especially around the wheels.
- When the tire pressure sensor batteries are exhausted.
- When using a wheel with no tire pressure sensor installed.
- When using tires with steel wire reinforcement in the side walls.
- When using tire chains.

**▼ Tires and Wheels**

**⚠ CAUTION**

*When inspecting or adjusting the tire air pressures, do not apply excessive force to the stem part of the wheel unit. The stem part could be damaged.*

**Changing tires and wheels**

The following procedure allows the TPMS to recognize a tire pressure sensor's unique ID signal code whenever tires or wheels are changed, such as changing to and from winter tires.

**NOTE**

*Each tire pressure sensor has a unique ID signal code. The signal code must be registered with the TPMS before it can work. The easiest way to do it is to have an Authorized Mazda Dealer change your tire and complete ID signal code registration.*

**When having tires changed at an Authorized Mazda Dealer**

Tire pressure sensor ID signal code registration is completed when an Authorized Mazda Dealer changes your vehicle's tires.

**When changing tires yourself**

If you or someone else changes tires, you or someone else can also undertake the steps for the TPMS to complete the ID signal code registration.

1. After tires have been changed, turn the ignition switch to the ON position, then turn it back to the ACC or LOCK position.
2. Wait for about 15 minutes.

Driving Your Mazda

## Starting and Driving

3. After about 15 minutes, drive the vehicle at a speed of at least 25 km/h (16 mph) for 10 minutes and the tire pressure sensor ID signal code will be registered automatically.

### **NOTE**

*If the vehicle is driven within about 15 minutes of changing tires, the tire pressure monitoring system warning light will flash because the sensor ID signal code would not have been registered. If this happens, park the vehicle for about 15 minutes, after which the sensor ID signal code will register upon driving the vehicle for 10 minutes.*

### **Replacing tires and wheels**

#### **CAUTION**

- *When replacing/repairing the tires or wheels or both, have the work done by an Authorized Mazda Dealer, or the tire pressure sensors may be damaged.*
- *The wheels equipped on your Mazda are specially designed for installation of the tire pressure sensors. Do not use non-genuine wheels, otherwise it may not be possible to install the tire pressure sensors.*

Be sure to have the tire pressure sensors installed whenever tires or wheels are replaced.

When having a tire or wheel or both replaced, the following types of tire pressure sensor installations are possible.

- The tire pressure sensor is removed from the old wheel and installed to the new one.
- The same tire pressure sensor is used with the same wheel. Only the tire is replaced.

- A new tire pressure sensor is installed to a new wheel.

### **NOTE**

- *The tire pressure sensor ID signal code must be registered when a new tire pressure sensor is purchased. For purchase of a tire pressure sensor and registration of the tire pressure sensor ID signal code, consult an Authorized Mazda Dealer.*
- *When reinstalling a previously removed tire pressure sensor to a wheel, replace the grommet (seal between valve body/sensor and wheel) for the tire pressure sensor.*

## Driving Your Mazda Instrument Cluster and Indicators

### Meters and Gauges

#### (Black-out meter)

When the ignition switch is in the ON position, the dashboard gauges illuminate.

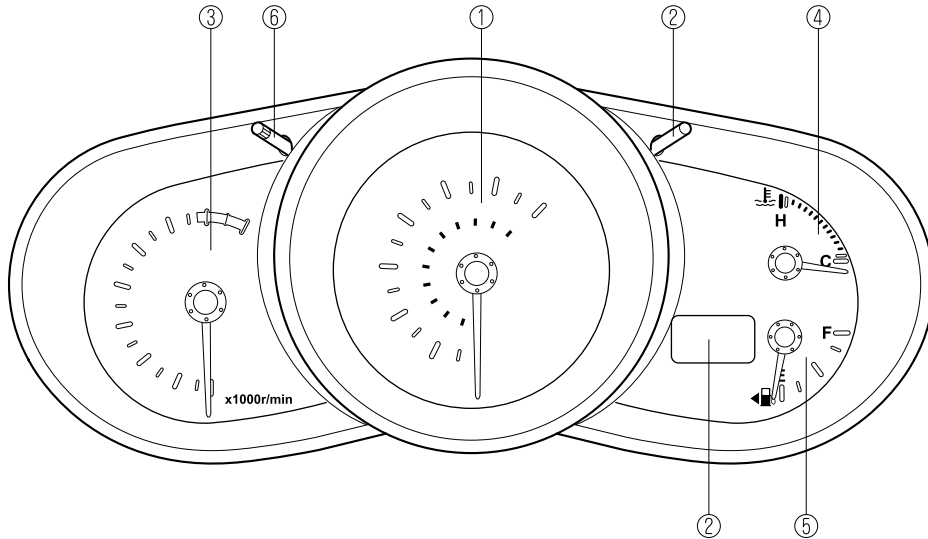

- ① Speedometer ..... page 5-34
- ② Odometer, Trip Meter and Trip Meter Selector ..... page 5-34
- ③ Tachometer ..... page 5-35
- ④ Engine Coolant Temperature Gauge ..... page 5-35
- ⑤ Fuel Gauge ..... page 5-36
- ⑥ Dashboard Illumination ..... page 5-36

Driving Your Mazda

## Instrument Cluster and Indicators

### ▼ Speedometer

The speedometer indicates the speed of the vehicle.

### ▼ Odometer, Trip Meter and Trip Meter Selector

The display mode can be changed between trip meter A and trip meter B by pressing the selector while one of them is displayed. The selected mode will be displayed.

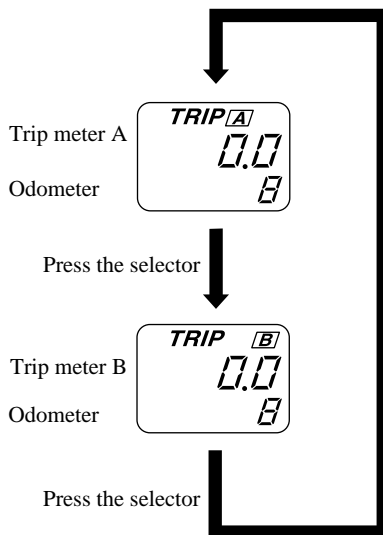
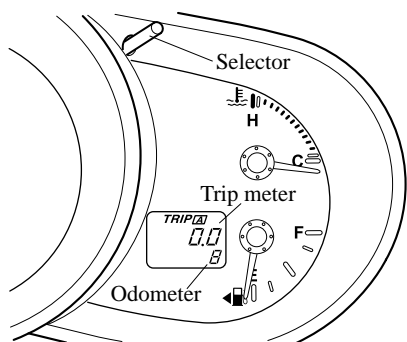

### NOTE

- **(Standard meter)**  
The odometer and trip meter can be displayed as follows even when the ignition switch is in the ACC or LOCK position.
  - Displays for 10 minutes after the ignition switch is turned to the ACC or LOCK position from the ON position.
  - Displays for 10 minutes after the driver's door is opened.
- **(Black-out meter)**  
When the ignition switch is in the ACC or LOCK position, the odometer or trip meters cannot be displayed, however, pressing the selector button can inadvertently switch the trip meters or reset them during an approximate ten-minute period in the following cases:
  - After the ignition switch is turned to the ACC or LOCK position from the ON position.
  - After the driver's door is opened.

## Driving Your Mazda Instrument Cluster and Indicators

### **Odometer**

The odometer records the total distance the vehicle has been driven.

### **Trip meter**

The trip meter can record the total distance of two trips. One is recorded in trip meter A, and the other is recorded in trip meter B.

For instance, trip meter A can record the distance from the point of origin, and trip meter B can record the distance from where the fuel tank is filled.

When trip meter A is selected, pressing the selector again within one second will change to trip meter B mode.

When trip meter A is selected, TRIP A will be displayed. When trip meter B is selected, TRIP B will be displayed.

The trip meter records the total distance the vehicle is driven until the meter is again reset. Return it to "0.0" by holding the selector depressed for more than 1 second. Use this meter to measure trip distances and to compute fuel consumption.

### ***NOTE***

- Only the trip meters record tenths of kilometers (miles).
- The trip record will be erased when:
  - The power supply is interrupted (blown fuse or the battery is disconnected).
  - The vehicle is driven over 999.9 km (mile).

### **▼ Tachometer**

The tachometer shows engine speed in thousands of revolutions per minute (rpm).

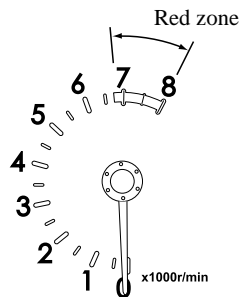

### **⚠ CAUTION**

*Don't run the engine with the tachometer needle in the RED ZONE. This may cause severe engine damage.*

### **▼ Engine Coolant Temperature Gauge**

The engine coolant temperature gauge shows the temperature of the engine coolant.

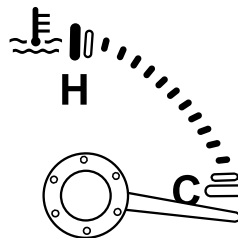

If the needle is near H, it indicates overheating.

Driving Your Mazda

## Instrument Cluster and Indicators

### **CAUTION**

*Driving with an overheated engine can cause serious engine damage (page 7-11).*

### ▼ Fuel Gauge

The fuel gauge shows approximately how much fuel is in the tank. We recommend keeping the tank over 1/4 full. When the low fuel warning light illuminates or when the needle is near E, refuel as soon as possible.

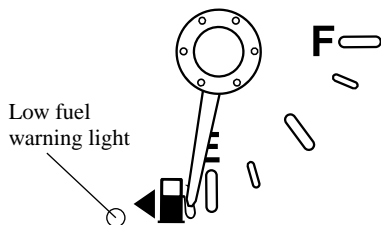

### **NOTE**

*The direction of the arrow (➔) shown next to the low fuel warning light indicates that the fuel-filler lid is on the left side of the vehicle.*

### ▼ Dashboard Illumination

Rotate the knob to adjust the brightness of the instrument cluster and other illuminations in the dashboard.

### **NOTE**

- *The brightness of dashboard illuminations can be adjusted when the headlight switch is in the ● or ☰ position.*
- *When the dashboard illumination brightness cannot be adjusted any more, a beep sound will be heard.*
- **(Black-out meter)**  
*The brightness of the instrument cluster illumination can be adjusted when the headlight switch is in any position.*

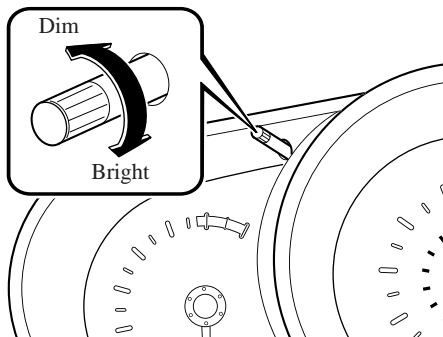

### **Canceling the illumination dimmer (Black-out meter and dashboard illuminations)**

When the headlight switch is in the ● or ☰ position, the illumination of the instrument cluster and the information display dims.

When driving on snowy or foggy roads, or in other situations when the instrument cluster or information display's visibility is reduced due to glare from surrounding brightness, cancel the illumination dimmer and increase the illumination intensity.

Driving Your Mazda  
**Instrument Cluster and Indicators**

---

To cancel the illumination dimmer, press the dashboard illumination knob.

**NOTE**

*If the dashboard illumination knob is kept at the illumination dimmer cancel position, the instrument cluster and the information display will not dim when the headlight switch is turned to the ● or ☰☽ position again.*





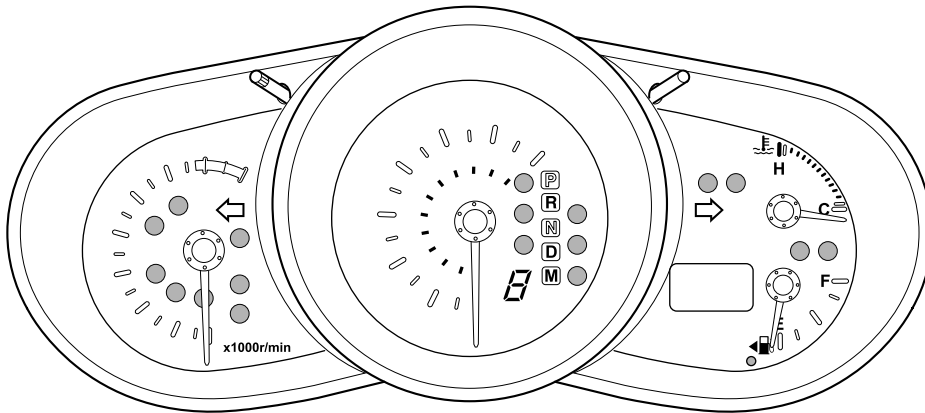

Driving Your Mazda

## Warning/Indicator Lights and Beep Sounds

### Warning/Indicator Lights











Warning/Indicator lights will appear in any of the highlighted areas

Signal	Warning/Indicator Lights	Page
	Brake System Warning Light	5-40
	Charging System Warning Light	5-41
	Engine Oil Pressure Warning Light	5-41
	Check Engine Light	5-42
	ABS Warning Light	5-40
	Air Bag/Front Seat Belt Pretensioner System Warning Light	5-42
	Low Fuel Warning Light	5-43



## Warning/Indicator Lights and Beep Sounds

Signal	Warning/Indicator Lights	Page
	Seat Belt Warning Light/Beep	5-43
	Door-Ajar Warning Light	5-44
	Low Washer Fluid Level Warning Light	5-44
<b>AT</b>	Automatic Transaxle Warning Light	5-45
<b>4WD</b>	AWD Warning Light	5-45
	Tire Pressure Monitoring System Warning Light	5-45
<b>KEY</b>	KEY Warning Light (Red)/KEY Indicator Light (Green)	5-47
	Security Indicator Light	5-49
	Headlight High-Beam Indicator Light	5-49
<i>PRNDM</i>	Shift Position Indicator Light	5-49
	TCS/DSC Indicator Light	5-50
<b>TCS OFF</b>	TCS OFF Indicator Light	5-50
<b>CRUISE</b>	Cruise Main Indicator Light (Amber)/Cruise Set Indicator Light (Green)	5-51
	Light-On Indicator Light	5-51
	Turn Signal/Hazard Warning Indicator Lights	5-51

Driving Your Mazda

## Warning/Indicator Lights and Beep Sounds

### ▼ Brake System Warning Light



This warning has the following functions:

#### **Parking brake warning**

The light comes on when the parking brake is applied with the ignition switch in the START or ON position. It goes off when the parking brake is fully released.

#### **Low brake fluid level warning**

If the light stays on after the parking brake is fully released, you may have a brake problem.

Drive to the side of the road and park off the right-of-way.

You may notice that the pedal is harder to push or that it may go closer to the floor. In either case, it will take longer to stop the vehicle.

1. With the engine stopped, check the brake fluid level immediately and add fluid as required (page 8-23).
2. After adding fluid, check the light again.

If the warning light remains on, or if the brakes do not operate properly, do not drive the vehicle. Have it towed to an Authorized Mazda Dealer.

Even if the light goes out have your brake system inspected as soon as possible by an Authorized Mazda Dealer.

5-40

### **NOTE**

*Having to add brake fluid is sometimes an indicator of leakage. Consult an Authorized Mazda Dealer as soon as possible even if the brake light is no longer illuminated.*

### **⚠ WARNING**

**Do not drive with the brake system warning light illuminated. Contact an Authorized Mazda Dealer to have the brakes inspected as soon as possible:**

*Driving with the brake system warning light illuminated is dangerous. It indicates that your brakes may not work at all or that they could completely fail at any time. If this light remains illuminated, after checking that the parking brake is fully released, have the brakes inspected immediately.*

### ▼ ABS Warning Light



The warning light stays on for a few seconds when the ignition switch is turned to the ON position.

If the ABS warning light stays on while you're driving, the ABS control unit has detected a system malfunction. If this occurs, your brakes will function normally as if the vehicle had no ABS. Should this happen, consult an Authorized Mazda Dealer as soon as possible.

## Warning/Indicator Lights and Beep Sounds

### NOTE

When the engine is jump-started to charge the battery, uneven rpm occurs and the ABS warning light comes on. This is due to a weak battery, not a malfunction.

Recharge the battery.

### ▼ Electronic Brake Force Distribution System Warning

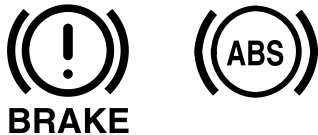

If the electronic brake force distribution control unit determines that some components are operating incorrectly, the control unit may turn the brake system warning light and the ABS warning light on at the same time. The problem is likely to be the electronic brake force distribution system.

### ⚠ WARNING

**Do not drive with both the ABS warning light and brake warning light illuminated. Have the vehicle towed to an Authorized Mazda Dealer to have the brakes inspected as soon as possible:**

*Driving when the brake system warning light and ABS warning light are illuminated at the same time is dangerous.*

*When both lights are illuminated, the rear wheels could lock more quickly in an emergency stop than under normal circumstances.*

### ▼ Charging System Warning Light



This warning light illuminates when the ignition switch is turned to the ON position and turns off when the engine is started.

If the warning light illuminates while driving, it indicates a malfunction of the alternator or of the charging system. Drive to the side of the road and park off the right-of-way. Consult an Authorized Mazda Dealer.

### ⚠ CAUTION

*Don't continue driving when the charging system warning light is illuminated because the engine could stop unexpectedly.*

### ▼ Engine Oil Pressure Warning Light



This warning light illuminates when the ignition switch is turned to the ON position and turns off when the engine is started.

This warning light indicates low engine oil pressure.

Driving Your Mazda

## Warning/Indicator Lights and Beep Sounds

If the light illuminates while driving:

1. Drive to the side of the road and park off the right-of-way on level ground.
2. Turn off the engine and wait 5 minutes for the oil to drain back into the oil pan.
3. Inspect the engine oil level (page 8-20). If it's low, add oil.
4. Start the engine and check the warning light.

If the light remains illuminated even after you add oil, stop the engine immediately and have your vehicle towed to an Authorized Mazda Dealer.

### CAUTION

*Don't run the engine if oil pressure is low. It could result in extensive engine damage.*

### ▼ Check Engine Light



This indicator light illuminates when the ignition switch is turned to the ON position and goes off when the engine is started.

If this light comes on while driving, the vehicle may have a problem. It is important to note the driving conditions when the light came on and consult an Authorized Mazda Dealer.

The check engine light may come on in the following cases:

- The fuel tank level being very low or approaching empty.
- The engine's electrical system has a problem.
- The emission control system has a problem.
- The fuel-filler cap is missing or not tightened securely.

If the check engine light remains on or flashes continuously, do not drive at high speeds and consult an Authorized Mazda Dealer as soon as possible.

### ▼ Air Bag/Front Seat Belt Pretensioner System Warning Light



If the air bag/front seat belt pretensioner system is working properly, the warning light illuminates when the ignition switch is turned to the ON position or after the engine is cranked. The warning light turns off after a specified period of time.

A system malfunction is indicated if the warning light constantly flashes, constantly illuminates or does not illuminate at all when the ignition switch is turned to the ON position. If any of these occur, consult an Authorized Mazda Dealer as soon as possible. The system may not work in an accident.

## Warning/Indicator Lights and Beep Sounds

### **⚠ WARNING**

**Never tamper with the air bag/pretensioner systems and always have an Authorized Mazda Dealer perform all servicing and repairs:**

*Self-servicing or tampering with the systems is dangerous. An air bag/pretensioner could accidentally activate or become disabled causing serious injury or death.*

#### ▼ Low Fuel Warning Light

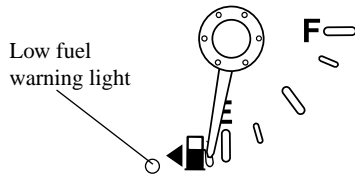

This warning light in the fuel gauge signals that the fuel tank will soon be empty.

Refuel as soon as possible.

#### ▼ Seat Belt Warning Light/Beep



The seat belt warning light illuminates and a beep sound will be heard if the driver's seat belt is not fastened when the ignition switch is turned to the ON position.

#### Conditions of operation

Condition	Result
The driver's seat belt is not fastened when the ignition switch is turned to the ON position.	The warning light flashes and a beep sound will be heard for about 6 seconds.
The driver's seat belt is fastened while the warning light and the beep sound are activated.	The warning light turns off and the beep sound stops.
The driver's seat belt is fastened before the ignition switch is turned to the ON position.	The warning light will not illuminate and the beep sound will not be heard.

#### Belt minder

##### **NOTE**

*The belt minder can be deactivated. Consult an Authorized Mazda Dealer to deactivate and restore the seat belt minder.*

#### **Driver seated/Front passenger not seated**

The belt minder is a supplemental warning to the seat belt warning function. If the driver's seat belt is not fastened when the ignition switch is turned to the ON position, the warning light/beep operates to give you further reminders according to the chart below.

Condition	Vehicle speed			
	Between 0 — 20 km/h (0 — 12 mph)	×	○	×
Seat belt	○	×	○	×
Indicator		⚡		⚡
Beep				♪

- : Fastened
- ×
- ×
- ⚡ : Illuminated
- ⚡ : Flashing
- ♪ : Beep

Driving Your Mazda

## Warning/Indicator Lights and Beep Sounds

Once the beep sound is heard, it continues sounding even if the vehicle speed lowers to 20 km/h (12 mph) or less until the seatbelt is fastened or the beep sound period has passed.

### Driver seated/Front passenger seated

The seat belt warning function reminds the front passenger to fasten the seat belt according to the chart below.

Condition	Vehicle speed							
	Between 0 — 20 km/h (0 — 12 mph)				20 km/h (12 mph) or more			
Seat belt (Driver)	○	○	×	×	○	○	×	×
Seat belt (Passenger)	○	×	○	×	○	×	○	×
Indicator			☾	☾	☾	☾	☾	
Beep					♪	♪	♪	

- : Fastened
- × : Unfastened
- ☾ : Illuminated
- ☾ : Flashing
- ♪ : Beep

Placing heavy items on the front passenger seat may cause the front passenger seat belt warning function to operate depending on the weight of the item.

Once the beep sound is heard, it continues sounding even if the vehicle speed lowers to 20 km/h (12 mph) or less until the seatbelt is fastened or the beep sound period has passed.

### NOTE

- To allow the front passenger seat weight sensor to function properly, do not place and sit on an additional seat cushion on the front passenger seat. The sensor may not function properly because the additional seat cushion could cause sensor interference.
- When a small child sits on the front passenger seat, it is possible that neither the warning light nor the warning beep operate.

### ▼ Door-Ajar Warning Light



This warning light illuminates when any door or liftgate is not securely closed. Close the door or liftgate securely before driving the vehicle.

### ▼ Low Washer Fluid Level Warning Light\*

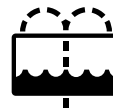

This warning light indicates that little washer fluid remains. Add fluid (page 8-27).

## Warning/Indicator Lights and Beep Sounds

### ▼ Automatic Transaxle Warning Light

# AT

This warning light stays on for a few seconds when the ignition switch is turned to the ON position.

The light illuminates when the transaxle has a problem.

#### CAUTION

*If the automatic transaxle warning light illuminates, the transaxle has an electrical problem. Continuing to drive your Mazda in this condition could cause damage to your transaxle. Consult an Authorized Mazda Dealer as soon as possible.*

### ▼ AWD Warning Light (AWD)

# 4WD

This warning light stays on for a few seconds when the ignition switch is turned to the ON position.

Thereafter, the warning light will illuminate or flash under the following conditions:

- Illuminates when there is an abnormality with the AWD system.
- Flashes when the differential oil temperature is abnormally high.

- Flashes when there are continually large differences between front and rear wheel rotation, such as when trying to pull away from an icy surface.

#### **If the AWD warning light illuminates:**

If the AWD warning light illuminates, contact an Authorized Mazda Dealer.

#### **If the AWD warning light flashes:**

Park the vehicle in a safe place. After a few moments; if the warning light stops flashing, you can resume driving. If the light does not stop flashing, contact an Authorized Mazda Dealer.

#### WARNING

**Never spin a wheel that is off the ground:**

*Spinning a wheel that is off the ground as a result of the vehicle being stuck or in a ditch is dangerous. The drive assembly could be seriously damaged which could lead to an accident or could even lead to overheating, oil leakage, and a fire.*

### ▼ Tire Pressure Monitoring System (TPMS) Warning Light\*



This warning light illuminates for a few seconds when the ignition switch is turned to the ON position.

\*Some models. **5-45**

Driving Your Mazda

## Warning/Indicator Lights and Beep Sounds

Thereafter, the warning light illuminates and a beep is heard when tire pressure is too low in one or more tires, and flashes when there is a system malfunction.

### **WARNING**

***If the tire pressure monitoring system warning light illuminates or flashes, or the tire pressure warning beep sound is heard, decrease vehicle speed immediately and avoid sudden maneuvering and braking:***

*If the tire pressure monitoring system warning light illuminates or flashes, or the tire pressure warning beep sound is heard, it is dangerous to drive the vehicle at high speeds, or perform sudden maneuvering or braking. Vehicle drivability could worsen and result in an accident. To determine if you have a slow leak or a flat, pull over to a safe position where you can check the visual condition of the tire and determine if you have enough air to proceed to a place where air may be added and the system monitored again, an Authorized Mazda Dealer or a tire repair station.*

***Do not ignore the TPMS Warning Light:***  
*Ignoring the TPMS warning light is dangerous, even if you know why it is illuminated. Have the problem taken care of as soon as possible before it develops into a more serious situation that could lead to tire failure and a dangerous accident.*

### **Warning light illuminates/Warning beep sounds**

When the warning light illuminates, and the warning beep sound is heard (about 3 seconds), tire pressure is too low in one or more tires.

Adjust the tire pressure to the correct tire pressure. Refer to the specification charts (page 10-6).

### **CAUTION**

*When replacing/repairing the tires or wheels or both, have the work done by an Authorized Mazda Dealer, or the tire pressure sensors may be damaged.*



## Warning/Indicator Lights and Beep Sounds

### NOTE

- Perform tire pressure adjustment when the tires are cold. Tire pressure will vary according to the tire temperature, therefore let the vehicle stand for 1 hour or only drive it 1.6 km (1 mile) or less before adjusting the tire pressures. When pressure is adjusted on hot tires to the cold inflation pressure, the TPMS warning light/beep may turn on after the tires cool and pressure drops below specification.

Also, an illuminated TPMS warning light, resulting from the tire air pressure dropping due to cold ambient temperature, may go out if the ambient temperature rises. In this case, it will also be necessary to adjust the tire air pressures. If the TPMS warning light illuminates due to a drop in tire air pressure, make sure to check and adjust the tire air pressures.

- After adjusting the tire air pressures, it may require some time for the TPMS warning light to go out. If the TPMS warning light remains illuminated, drive the vehicle at a speed of at least 25 km/h (16 mph) for 10 minutes, and then verify that it goes out.
- Tires can lose a little air quite naturally over time and the TPMS cannot tell if the tires are getting too soft over time or you have a flat. However, when you find one low tire in a set of four - that is an indication of trouble; you should have someone drive the vehicle slowly forward so you can inspect any low tire for cuts and any metal sticking through tread or sidewall. Put a few drops of water in the valve stem to see if it bubbles indicating a bad valve. Leaks need to be addressed by more than simply refilling the trouble tire as leaks are dangerous - take it to an Authorized Mazda Dealer which has all the equipment to fix tires, TPMS systems and order the best replacement tire for your vehicle.

If the warning light illuminates again even after the tire pressures are adjusted, there may be a tire puncture. Replace the punctured tire with the temporary spare tire (page 7-6).

### NOTE

A tire pressure sensor is not installed to the temporary spare tire. The warning light will flash continuously while the temporary spare tire is being used.

### Warning light flashes

When the warning light flashes, there may be a system malfunction. Consult an Authorized Mazda Dealer.

### ▼ KEY Warning Light (Red)/KEY Indicator Light (Green) (with Advanced Key)

# KEY

This indicator has two colors.

### KEY Warning Light (Red)

#### When illuminated

- When the ignition switch is turned to the ON position, it illuminates momentarily and then goes out.
- If any malfunction occurs in the advanced keyless system, it illuminates continuously.

Driving Your Mazda

## Warning/Indicator Lights and Beep Sounds

### **WARNING**

**Do not drive the vehicle with the KEY warning light illuminated:**

*If the KEY warning light remains illuminated, do not continue to drive using the advanced key system. Park the vehicle in a safe place and use the auxiliary key to continue driving the vehicle. Have the vehicle inspected at an Authorized Mazda Dealer as soon as possible.*

#### **When flashing**

- Under the following conditions, the KEY warning light (red) flashes to inform the driver that the start knob will not rotate to the ACC position even if it is pushed in from the LOCK position.
  - The advanced key battery is dead.
  - The advanced key is not within operational range.
  - The advanced key is placed in areas where it is difficult for the system to detect the signal (page 3-7).
  - A key from another manufacturer similar to the advanced key is in the operational range.

- Under the following conditions, the KEY warning light (red) will flash continuously when the start knob has not been returned to the LOCK position to notify the driver that the advanced key has been removed from the vehicle. It will stop flashing when the advanced key is back inside the vehicle.
  - The start knob has not been returned to the LOCK position, the driver's door is open, and the advanced key is removed from the vehicle.
  - The start knob has not been returned to the LOCK position and all the doors are closed after removing the advanced key from the vehicle.

#### **NOTE**

*The flashing KEY warning light (red) and the beep sound operate simultaneously (page 3-19).*

#### **KEY Indicator Light (Green)**

##### **When illuminated**

When the start knob is pushed in from the LOCK position, the system confirms that the correct advanced key is inside the vehicle, the KEY indicator light (green) illuminates, and the start knob can be turned to the ACC position (page 3-9).

##### **When flashing**

When the advanced key battery power is low, the KEY indicator light flashes for 30 seconds after the start knob is turned from the ON position to the ACC or LOCK position. Replace with a new battery before the advanced key becomes unusable (page 3-6).

## Warning/Indicator Lights and Beep Sounds

### NOTE

The advanced key can be set so that the KEY indicator light (green) does not flash even if the battery power is low.  
Refer to Setting Change (Function Customization)(page 3-18).

### ▼ Security Indicator Light



This indicator light starts flashing every 2 seconds when the ignition switch is turned from the ON to the ACC position and the immobilizer system is armed.

The light stops flashing when the ignition switch is turned to the ON position with the correct ignition key.

At this time, the immobilizer system is disarmed and the light illuminates for about 3 seconds and then goes out.

If the engine doesn't start with the correct ignition key, and the security indicator light keeps illuminating or flashing, the system may have a malfunction. Consult an Authorized Mazda Dealer.

### ▼ Headlight High-Beam Indicator Light



This light indicates one of two things:

- The high-beam headlights are on.
- The turn signal lever is in the flash-to-pass position.

### ▼ Shift Position Indicator Light

This indicates the selected shift position when the ignition switch is in the ON position.



Gear position indicator

Driving Your Mazda

## Warning/Indicator Lights and Beep Sounds

---

### Gear position indicator

When the shift lever is in the D or M position, the numeral for the selected gear displays.

### ▼ TCS/DSC Indicator Light



This indicator light stays on for a few seconds when the ignition switch is turned to the ON position. If the TCS or DSC is operating, the indicator light flashes.

If the light stays on, the TCS, DSC or the brake assist system may have a malfunction and they may not operate correctly. Take your vehicle to an Authorized Mazda Dealer.

### ▼ TCS OFF Indicator Light

# TCS OFF

This indicator light stays on for a few seconds when the ignition switch is turned to the ON position.

It also illuminates when the TCS OFF switch is pressed and TCS is switched off. Refer to TCS OFF Switch on page 5-24. If the light remains illuminated and the TCS is not switched off, take your vehicle to an Authorized Mazda Dealer. The dynamic stability control may have a malfunction.

## Warning/Indicator Lights and Beep Sounds

### **NOTE**

If the battery is disconnected or a fuse is replaced, the DSC will be inoperable. When this happens, the TCS OFF indicator light flashes and the TCS/DSC indicator light illuminates.

To reactivate the DSC, perform the following procedure with the battery connected.

1. Turn the ignition switch to the ON position.
2. Turn the steering clockwise fully, then turn it counterclockwise fully.
3. Make sure the TCS OFF indicator turns off.
4. Turn the ignition switch to the OFF position, then turn it to the ON position again.
5. Make sure the TCS/DSC indicator light turns off.

If the TCS/DSC indicator light and the TCS OFF indicator light remain illuminated even after turning the ignition switch to the ON position, attempt the procedure again. If this still does not work, consult an Authorized Mazda Dealer.

### ▼ **Cruise Main Indicator Light (Amber)/Cruise Set Indicator Light (Green)**

# CRUISE

The indicator light has two colors.

#### **Cruise Main Indicator Light (Amber)**

The indicator light illuminates amber when the ON/OFF switch is pressed and the cruise control system is activated.

#### **Cruise Set Indicator Light (Green)**

The indicator light illuminates green when a cruising speed has been set.

#### ▼ **Light-On Indicator Light**



This indicator light comes on when the exterior lights and dashboard illumination are on.

#### ▼ **Turn-Signal/Hazard Warning Indicator Lights**

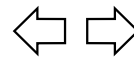

When operating the turn signal lights, the left or right turn signal indicator light flashes to indicate which turn signal light is operating (page 5-56).

When operating the hazard warning lights, both turn signal indicator lights flash (page 5-60).

#### **NOTE**

If an indicator light remains illuminated (does not flash) or if it flashes abnormally, one of the turn signal bulbs may be burned out.

Driving Your Mazda

## Warning/Indicator Lights and Beep Sounds

### Beep Sounds

#### ▼ Air Bag/Front Seat Belt Pretensioner System Warning Beep

If a malfunction is detected in both the air bag/front seat belt pretensioner system and the warning light, a warning beep sound will be heard for about 1 minute. After that, the one-minute beep will be repeated every 30 minutes.

Have your vehicle inspected at an Authorized Mazda Dealer as soon as possible.

#### **⚠ WARNING**

**Do not drive the vehicle with the air bag/front seat belt pretensioner system warning beep sounding:**

*Driving the vehicle with the air bag/front seat belt pretensioner system warning beep sounding is dangerous. In a collision, the air bags and the front seat belt pretensioner system will not deploy and this could result in death or serious injury. Contact an Authorized Mazda Dealer to have the vehicle inspected as soon as possible.*

#### ▼ Seat Belt Warning Beep

If the driver's seat belt is not fastened when the ignition switch is turned to the ON position, a beep sound will be heard for about 6 seconds.

If the driver's seat belt is not fastened and the vehicle is driven at a speed faster than about 20 km/h (12 mph), a beep sound will be heard again for a specified period of time.

Refer to Seat Belt Warning Light/Beep on page 5-43.

#### ▼ Ignition Key Reminder

If the ignition switch is in the LOCK or ACC position with the key inserted, a continuous beep sound will be heard when the driver's door is opened.

#### ▼ Lights-On Reminder

If lights are on and the key is removed from the ignition switch, a continuous beep sound will be heard when the driver's door is opened.

#### **NOTE**

*When the advanced keyless function is used and the start knob is in the ACC position, the "Start Knob Not in LOCK Warning Beep" (page 3-16) overrides the lights-on reminder.*

#### ▼ Parking Brake Reminder

If the parking brake has not been completely released and the vehicle is driven at about 5 km/h (3 mph) or faster, a continuous beep sound will be heard to notify the driver that the parking brake has not been released.

#### ▼ Tire Inflation Pressure Warning Beep

The warning beep sound will be heard for about 3 seconds when there is any abnormality in tire inflation pressures (page 5-27).

#### ▼ Advanced Keyless Warning

Warning indicators for the advanced key, such as "the advanced key removed from vehicle warning", use a beep sound and warning/indicator lights in the instrument cluster.

Refer to Warning and Beep Sounds on page 3-16.

## Switches and Controls

### Lighting Control

#### ▼ Headlights

##### Type A (Without AUTO position)

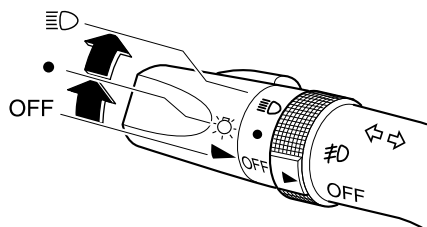

Turn the headlight switch to turn the headlights, other exterior lights and dashboard illumination on or off.

Switch Position	OFF	●	☰
Headlights	Off	Off	On
Taillights	Off	On	On
Parking lights			
License lights			
Side-marker lights			
Dashboard illumination			

**NOTE**

To prevent discharging the battery, don't leave the lights on while the engine is off unless safety requires them.

##### Type B (With AUTO position)

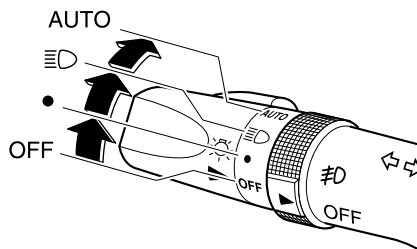

Turn the headlight switch to turn the headlights, other exterior lights and dashboard illumination on or off.

Switch Position	OFF	●	☰	AUTO
Headlights	Off	Off	On	Auto
Taillights	Off	On	On	
Parking lights				
License lights				
Side-marker lights				
Dashboard illumination				

**NOTE**

To prevent discharging the battery, don't leave the lights on while the engine is off unless safety requires them.

**AUTO (Auto-light control)**

When the headlight switch is in the AUTO position and the ignition switch is in the ON position, the light sensor senses the surrounding lightness or darkness and automatically turns on or off the headlights, other exterior lights and dashboard illumination (see chart above).

Driving Your Mazda

## Switches and Controls

### **CAUTION**

Do not shade the light sensor by adhering a sticker or a label on the windshield, or putting an object on it. Otherwise the light sensor will not operate correctly.

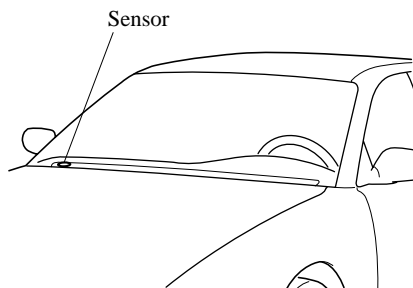

### **NOTE**

- When the headlight switch is in the *AUTO* position and the ignition switch is turned to the *ACC* or *LOCK* position, the headlights, other exterior lights and dashboard illumination will turn off.
- The timing for turning on the headlights, other exterior lights and dashboard illumination can be delayed by adjusting the sensitivity of the light sensor. Consult an Authorized Mazda Dealer regarding sensor adjustment.

### **Xenon fusion headlight bulbs\***

The low-beam bulbs of the headlights have xenon fusion bulbs that produce a bright white beam over a wide area.

### **WARNING**

**Do not replace the xenon fusion bulbs yourself:**

Replacing the xenon fusion bulbs yourself is dangerous. Because the xenon fusion bulbs require high voltage, you could receive an electric shock if the bulbs are handled incorrectly. Consult an Authorized Mazda Dealer when the replacement is necessary.

### **NOTE**

If the headlights flicker, or the brightness weakens, the bulb-life may be depleted and a replacement is necessary. Consult an Authorized Mazda Dealer.

### **▼ Lights-On Reminder**

If lights are on and the key is removed from the ignition switch, a continuous beep sound will be heard when the driver's door is opened.

### **NOTE**

When the advanced keyless function is used and the start knob is in the *ACC* position, the "Start Knob Not in *LOCK* Warning Beep" (page 3-16) overrides the lights-on reminder.



## Switches and Controls

### ▼ Headlight High-Low Beam

Push the lever forward for high beam.  
 Pull back to original position for low beam.

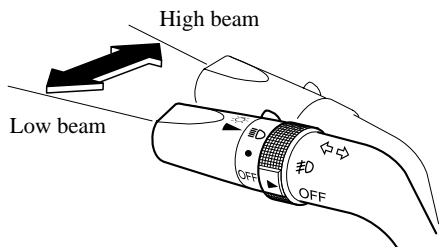

### ▼ Flashing the Headlights

To flash the headlights, pull the lever fully toward you. The headlight switch does not need to be on, and the lever will return to the normal position when released.

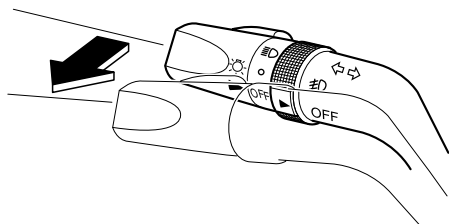

### ▼ Headlight Leveling\*

The number of passengers and weight of cargo in the luggage compartment change the angle of the headlights.  
 The headlight leveling switch adjusts this angle.

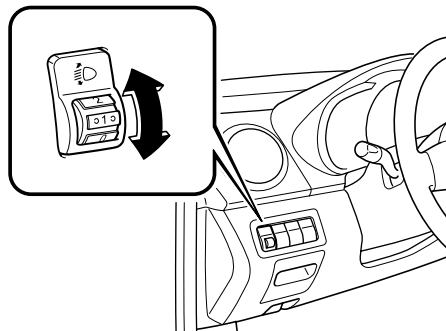

Select the proper setting from the following chart.

Front seat		Rear seat	Load	Switch Position
Driver	Passenger			
×	—	—	—	0
×	×	—	—	0
×	×	×	—	1
×	×	×	×	2
×	—	—	×	3

×: Yes

—: No

### ▼ Daytime Running Lights (Canada)

In Canada, vehicles must be driven with the headlights on during daytime operation.

For that reason, the daytime running lights automatically turn on when the ignition switch is turned to the ON position.

#### **NOTE**

*The Daytime Running Lights turn off when the parking brake is applied.*

Driving Your Mazda

## Switches and Controls

### Turn and Lane-Change Signals

#### ▼ Turn Signal

Move the signal lever down (for a left turn) or up (for a right turn) to the stop position. The signal will self-cancel after the turn is completed.

If the indicator light continues to flash after a turn, manually return the lever to its original position.

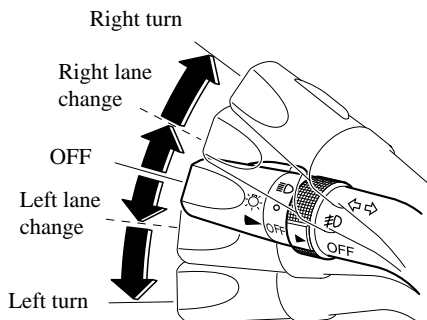

Green indicators on the dashboard show which signal is working.

#### Lane-change signals



Move the lever slightly toward the direction of the change —until the indicator flashes— and hold it there. It will return to the off position when released.

#### **NOTE**

*If an indicator light stays on without flashing or if it flashes abnormally, one of the turn signal bulbs may be burned out.*

### Fog Lights\*

Use this switch to turn on the fog lights. They help you to see as well as to be seen.

To turn the front fog lights on, rotate the fog light switch to the  position. The headlight switch must be in the  position to turn on the front fog lights.

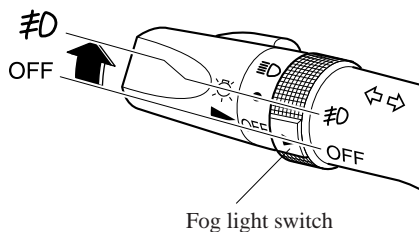

To turn them off, rotate the fog light switch to the OFF position or turn the headlight switch to the  or OFF position.

#### **NOTE**

- The fog lights will turn off when the headlights are set at high beam.
- **(With auto-light control)**  
*If the fog light switch is in the ON position and the headlight switch is in the AUTO position, the front fog lights will be turned on when the headlights, the exterior lights and dashboard illumination are automatically turned on.*

## Driving Your Mazda Switches and Controls

### Windshield Wipers and Washer

The ignition switch must be in the ON position.

#### **! WARNING**

**Use only windshield washer fluid or plain water in the reservoir:**

Using radiator antifreeze as washer fluid is dangerous. If sprayed on the windshield, it will dirty the windshield, affect your visibility, and could result in an accident.

**Do not use the washer without first warming the windshield and never use plain tap water:**

Using windshield washer fluid without anti-freeze protection in freezing temperatures is dangerous. The washer fluid could freeze on the windshield and block your vision. You could have an accident.

#### **NOTE**

Because heavy ice and snow can jam the wiper blades, the wiper motor is protected from motor breakdown, overheating and possible fire by a circuit breaker. This mechanism will automatically stop operation of the blades, but only for about 5 minutes.

If this happens, turn off the wiper switch and park off the right-of-way, and remove the snow and ice.

After 5 minutes, turn on the switch and the blades should operate normally. If they don't resume functioning, consult an Authorized Mazda Dealer as soon as possible. Drive to the side of the road and park off the right-of-way. Wait until the weather clears before trying to drive with the wipers inoperative.

### ▼ Windshield Wipers

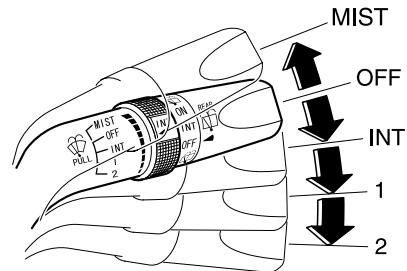

Turn the wipers on by pulling the lever down.

**INT** — Intermittent

**1** — Low speed

**2** — High speed

For a single wiping cycle, push the lever up to MIST.

**MIST** — Mist

#### **Variable-speed intermittent wipers**

Set the lever to INT and choose the interval timing by rotating the ring.

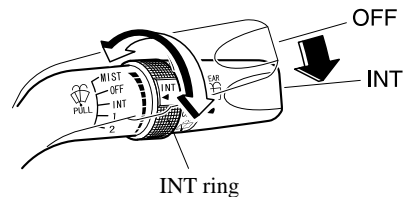

Driving Your Mazda

## Switches and Controls

### ▼ Windshield Washer

Pull the lever toward you and hold it to spray washer fluid.

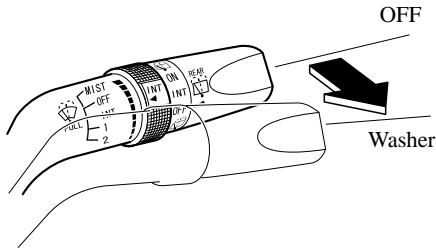

#### **NOTE**

With the wiper lever in the OFF or INT position, the wipers will operate continuously until the lever is released.

If the washer doesn't work, inspect the fluid level (page 8-27). If it's OK, consult an Authorized Mazda Dealer.

### Rear Window Wiper and Washer

The ignition switch must be in the ON position.

#### ▼ Rear Window Wiper

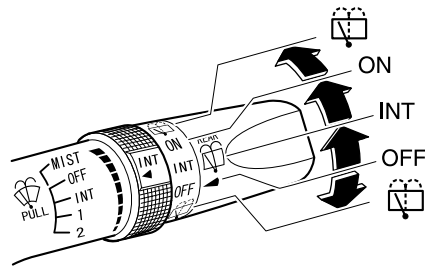

Turn the wiper on by turning the rear wiper/washer switch.

**ON** — Normal  
**INT** — Intermittent

#### ▼ Rear Window Washer

To spray washer fluid, turn the rear wiper/washer switch to the  position. After the switch is released, the washer will stop.

If the washer doesn't work, inspect the fluid level (page 8-27). If it's OK and the washer still doesn't work, consult an Authorized Mazda Dealer.

Driving Your Mazda  
**Switches and Controls**

### Rear Window Defroster

The rear window defroster clears frost, fog, and thin ice from the rear window.

The ignition switch must be in the ON position.

Press the switch to turn on the rear window defroster. The rear window defroster operates for about 15 minutes and turns off automatically. The indicator light illuminates during operation.

To turn off the rear window defroster before the 15 minutes has elapsed, press the switch again.

### Manual Type Air Conditioning

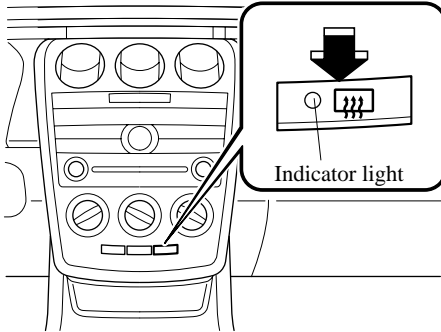

### Fully Automatic Type Air Conditioning

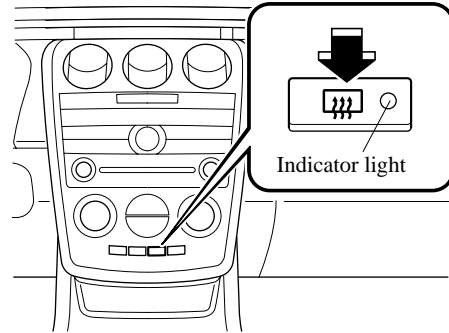

### **CAUTION**

*Don't use sharp instruments or window cleaners with abrasives to clean the inside of the rear window surface. They may damage the defroster grid inside the window.*

### **NOTE**

*This defroster is not designed for melting snow. If there is an accumulation of snow on the rear window, remove it before using the defroster.*

Driving Your Mazda

## Switches and Controls

### Horn

To sound the horn, press the  mark on the steering wheel.

### Hazard Warning Flasher

The hazard warning lights should always be used when you stop on or near a roadway in an emergency.

The hazard warning lights warn other drivers that your vehicle is a traffic hazard and that they must take extreme caution when near it.

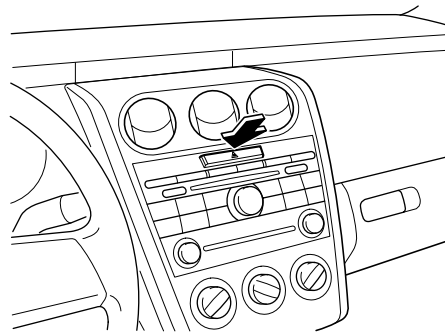

Depress the hazard warning flasher and all the turn signals will flash.

#### **NOTE**

- *The turn signals do not work when the hazard warning lights are on.*
- *Check local regulations about the use of hazard warning lights while the vehicle is being towed to verify that it is not in violation of the law.*

## 6 Interior Comfort

Use of various features for drive comfort, including air-conditioning and audio system.

<b>Climate Control System .....</b>	<b>6-2</b>
Operating Tips .....	6-2
Vent Operation .....	6-3
Types of the Climate Control System .....	6-5
Manual Type * .....	6-6
Fully Automatic Type * .....	6-10
<b>Audio System .....</b>	<b>6-15</b>
Antenna .....	6-15
Operating Tips for Audio System .....	6-15
Audio Set .....	6-25
Audio Control Switch Operation (Steering Wheel) * .....	6-42
Safety Certification .....	6-45
<b>Interior Equipment .....</b>	<b>6-46</b>
Sunvisors .....	6-46
Interior Lights .....	6-47
Information Display .....	6-49
Cup Holder .....	6-51
Bottle Holder .....	6-52
Storage Compartments .....	6-53
Accessory Sockets .....	6-54

\*Some models. **6-1**

Interior Comfort

## Climate Control System

### Operating Tips

#### ▼ Operating the Climate Control System

Operate the climate control system with the engine running.

##### **NOTE**

*To prevent the battery from being discharged, do not leave the fan control dial on for a long period of time with the ignition switch in the ACC position when the engine is not running.*

#### ▼ Clearing the Air Inlet

Clear all obstructions like leaves, snow and ice from the hood and the air inlet in the cowl grille to improve the system efficiency.

#### ▼ Foggy Windows

The windows may fog up easily in humid weather. Use the climate control system to defog the windows.

To help defog the windows, operate the air conditioner to dehumidify the air.

##### **NOTE**

*The air conditioner may be used along with the heater to dehumidify the air.*

#### ▼ Outside/Recirculated Air Position

Use the outside air position in normal conditions. The recirculated air position should be used only when driving on dusty roads or for quick cooling of the interior.

#### ▼ Parking in Direct Sunlight

If the vehicle has been parked in direct sunlight during hot weather, open the windows to let warm air escape, then run the climate control system.

#### ▼ Not Using for a Long Period

Run the air conditioner about 10 minutes at least once a month to keep internal parts lubricated.

#### ▼ Check the Refrigerant before the Weather Gets Hot

Have the air conditioner checked before the weather gets hot. Lack of refrigerant may make the air conditioner less efficient. Consult an Authorized Mazda Dealer for refrigerant inspection.

The air conditioner is filled with HFC134a (R134a), a refrigerant that will not damage the ozone layer. If the air conditioner is low on refrigerant or has a malfunction, consult an Authorized Mazda Dealer.



Interior Comfort  
**Climate Control System**

**Vent Operation**

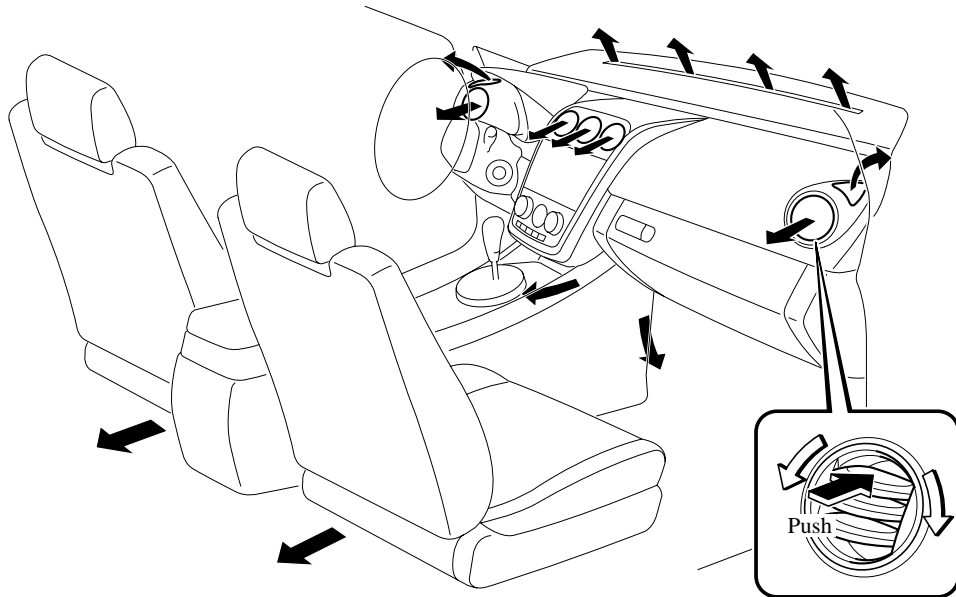

▼ **Adjusting the Vents**

**Directing airflow**

You can direct air flow by rotating the vent.

**Opening/closing vents**

These vents can be opened and closed with wheel.

**NOTE**

*When using the air conditioner, mist may come out from the vents. This is not a sign of trouble but a result of humid air being suddenly cooled.*

Interior Comfort

# Climate Control System

## ▼ Selecting the Airflow Mode

### Dashboard Vents

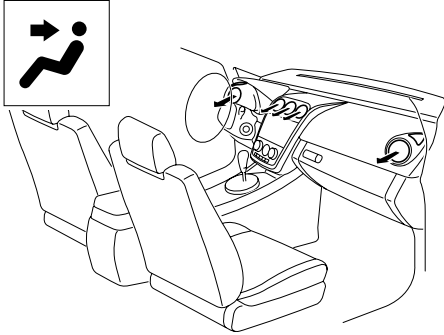

### Defroster and Floor Vents

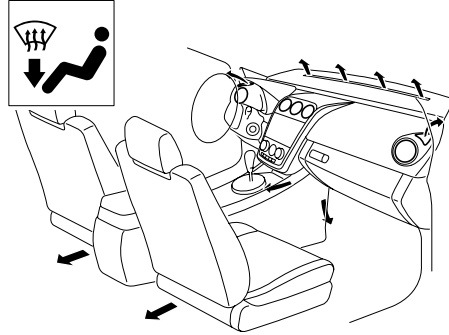

### Dashboard and Floor Vents

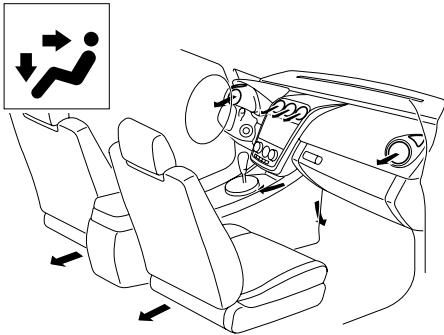

### Defroster Vents

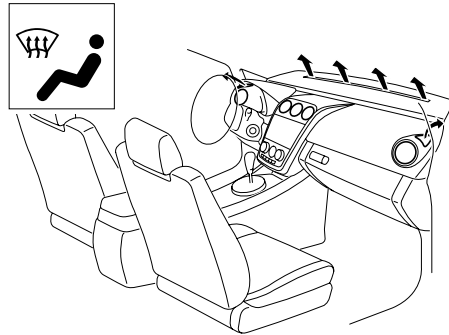

### Floor Vents

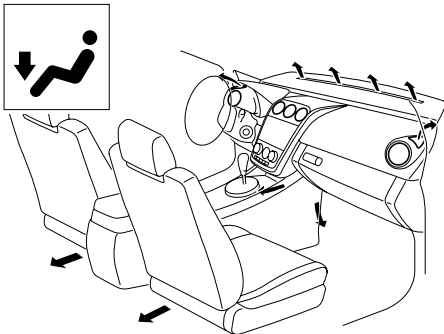

Interior Comfort  
**Climate Control System**

**Types of the Climate Control System**

Manual type and fully automatic type climate control systems are explained separately.  
Check your vehicle's climate control type and read the appropriate pages.

Manual Type ..... page 6-6

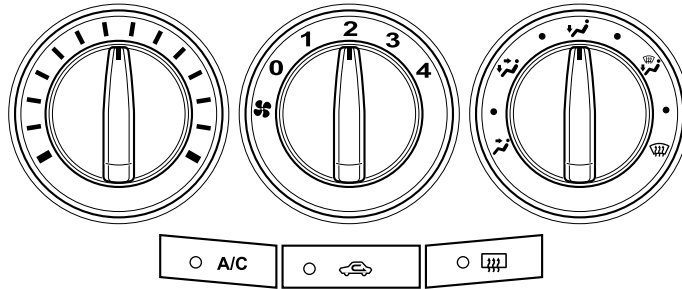

Fully Automatic Type ..... page 6-10

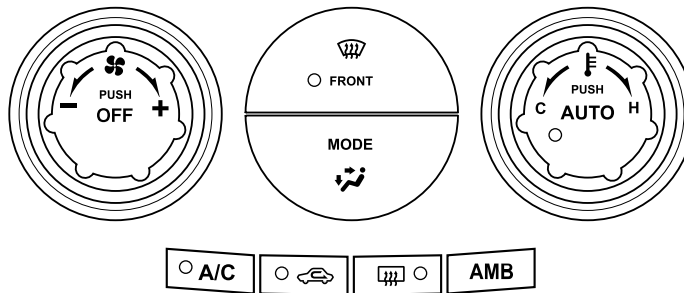

Interior Comfort

# Climate Control System

## Manual Type \*

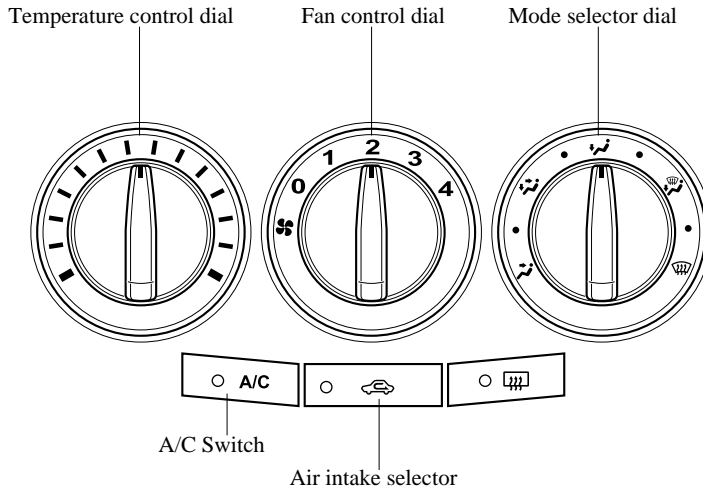

### ▼ Control Switches

#### Temperature control dial

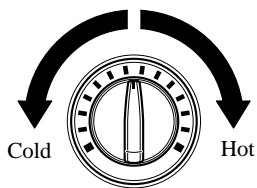

This dial controls temperature. Turn it clockwise for hot and counterclockwise for cold.

#### Fan control dial

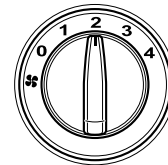

This dial allows variable fan speeds.

- 0—Fan off
- 1—Low speed
- 2—Medium low speed
- 3—Medium high speed
- 4—High speed

Interior Comfort

## Climate Control System

### Mode selector dial

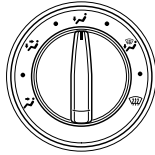

Turn the mode selector dial to select airflow mode (page 6-4).

#### **NOTE**

- If you want to slightly adjust the airflow amount, set the mode selector dial at ● .
- For example, when the mode selector dial is at the ● position between the ↻ and ↻ positions, airflow from the floor vent is less than that of the ↻ position.

### A/C switch \*

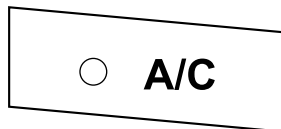

Push the A/C switch to turn the air conditioner on. The indicator light on the switch will illuminate when the fan control dial is set at position 1, 2, 3, or 4.

Push the switch once again to turn the air conditioner off.

#### **NOTE**

- The air conditioner may not function when the outside temperature approaches 0 °C (32 °F).
- (U.S.A., Canada)  
When the mode is set to ↻ or ↻ with the fan control dial in a position other than 0 and the temperature control dial in the maximum cold position, the air intake selector switches to the recirculated air mode and the A/C turns on.  
If A/C is not desired, press the A/C switch to turn it off.

### Air intake selector

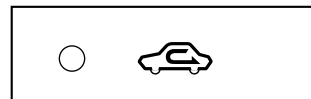

This switch controls the source of air entering the vehicle.

Press the  switch to alternate between the outside air and recirculated air modes.

It is recommended that under normal conditions the switch be kept in the outside air mode.

#### **Outside air mode (indicator light turned off)**

Outside air is taken into the vehicle. Use this mode for normal ventilation and heating.

#### **Recirculated air mode (indicator light illuminated)**

Outside air is shut off. Air within the vehicle is recirculated.

\*Some models.

6-7

Interior Comfort

## Climate Control System

This mode can be used when driving on a dusty road or in similar conditions. It also helps to provide quicker cooling of the interior.

### WARNING







**Do not use the recirculated air mode in cold or rainy weather:**

*Using the recirculated air mode in cold or rainy weather is dangerous as it will cause the windows to fog up. Your vision will be hampered, which could lead to a serious accident.*

### ▼ Heating

1. Set the mode selector dial to the  position.
2. Set the temperature control dial to the hot position.
3. Set the fan control dial to the desired speed.

### NOTE

- If the windshield fogs up easily, set the mode selector dial to the  position.
- If cooler air is desired at face level, set the mode selector dial at the  position and adjust the temperature control dial to maintain maximum comfort.
- The air to the floor is warmer than air to the face (except when the temperature control dial is set at the extreme hot or cold position).
- In the , , or  position, the air conditioner is automatically turned on (however, the indicator light does not illuminate) and the outside air mode is automatically selected to defrost the windshield.  
In the  or  position, the outside air mode cannot be changed to the recirculated air mode.

### ▼ Cooling (With Air Conditioner)\*

1. Set the mode selector dial to the  position.
2. Set the temperature control dial to the cold position.
3. Set the fan control dial to the desired speed.
4. Turn on the air conditioner by pressing the A/C switch.
5. Adjust the fan control dial and temperature control dial to maintain maximum comfort.

### CAUTION

*When using the air conditioner while driving up long hills or in heavy traffic, closely monitor the temperature gauge (page 5-35). The air conditioner may cause engine overheating. If the gauge indicates overheating, turn the air conditioner off (page 7-11).*

### NOTE

- When maximum cooling is desired, set the temperature control dial to the extreme cold position and set the air intake selector to the recirculated air mode, then set the fan control dial to position 4.
- If warmer air is desired at floor level, set the mode selector dial at the  position and adjust the temperature control dial to maintain maximum comfort.
- The air to the floor is warmer than air to the face (except when the temperature control dial is set at the extreme hot or cold position).

## Climate Control System

### ▼ Ventilation



1. Set the mode selector dial to the  position.
2. Set the air intake selector to the outside air mode.
3. Set the temperature control dial to the desired position.
4. Set the fan control dial to the desired speed.

### ▼ Windshield Defrosting and Defogging







1. Set the mode selector dial to the  position.
2. Set the temperature control dial to the desired position.
3. Set the fan control dial to the desired speed.

### WARNING

**Do not defog the windshield using the  position with the temperature control set to the cold position:**

*Using the  position with the temperature control set to the cold position is dangerous as it will cause the outside of the windshield to fog up. Your vision will be hampered, which could lead to a serious accident. Set the temperature control to the hot or warm position when using the  position.*

### NOTE

- For maximum defrosting, set the temperature control dial to the extreme hot position and the fan control dial to position 4.
- If warm air is desired at the floor, set the mode selector dial to the  position.
- In the , , or  position, the air conditioner is automatically turned on (however, the indicator light does not illuminate) and the outside air mode is automatically selected to defrost the windshield.  
In the  or  position, the outside air mode cannot be changed to the recirculated air mode.

### ▼ Dehumidifying (With Air Conditioner)\*

Operate the air conditioner in cool or cold weather to help defog the windshield and side windows.

1. Set the mode selector dial to the desired position.
2. Set the air intake selector to the outside air mode.
3. Set the temperature control dial to the desired position.
4. Set the fan control dial to the desired speed.
5. Turn on the air conditioner by pressing the A/C switch.

### NOTE

*One of the functions of the air conditioner is dehumidifying the air and, to use this function, the temperature does not have to be set to cold. Therefore, set the temperature control dial to the desired position (hot or cold) and turn on the air conditioner when you want to dehumidify the cabin air.*

\*Some models.

Interior Comfort

# Climate Control System

## Fully Automatic Type\*

Climate control information is displayed on the information display.

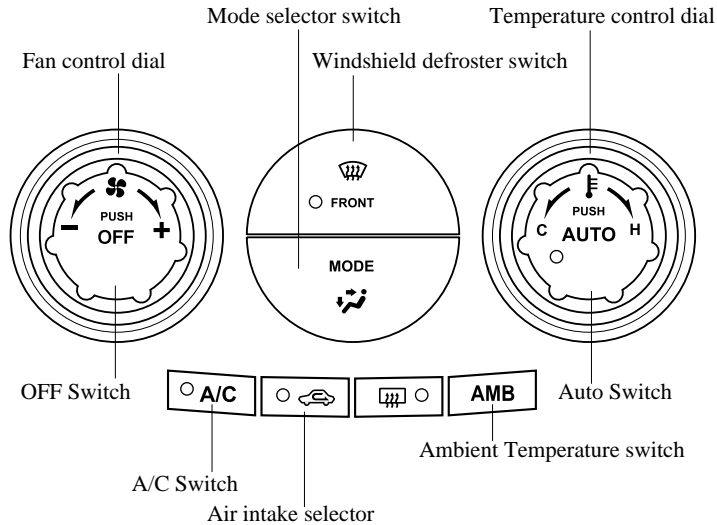

### ▼ Control Switches

#### AUTO switch

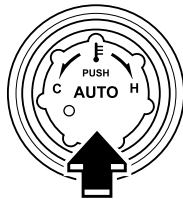

By pressing the AUTO switch the following functions will be automatically controlled in accordance with the set temperature:

- Airflow temperature
- Amount of airflow
- Selection of airflow mode

- Outside/Recirculated air selection
- Air conditioner operation

#### **NOTE**

*AUTO switch indicator light*

- When on, it indicates AUTO operation, and the system will function automatically.
- When off, it indicates the operation of other switches such as the mode selector switch, fan control dial, A/C switch and windshield defroster switch. Other functions will continue to operate automatically.

**6-10** \*Some models.



Interior Comfort  
**Climate Control System**

**OFF switch**

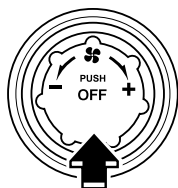

Pressing the OFF switch shuts off the climate control system.

**Temperature control dial**

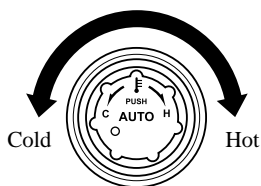

This dial controls temperature. Turn it clockwise for hot and counterclockwise for cold.

**Fan control dial**

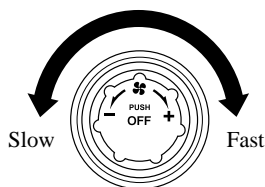

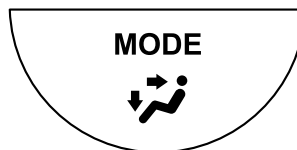

The fan has seven speeds. The selected speed will be displayed.

**Mode selector switch**



The desired airflow mode can be selected (page 6-4).

**NOTE**

- With the airflow mode set to  position and the temperature control dial set at a medium temperature, heated air is directed to the feet and a comparably lower air temperature will flow through the central, left and right vents.
- To set the air vent to , press the windshield defroster switch.

**A/C switch**



With the AUTO or fan control dial ON, press the A/C switch to select the air conditioning (cooling/dehumidifying functions) on or off.

**NOTE**

The air conditioner may not function when the outside temperature approaches 0 °C (32 °F). (Indicator remains on even when system is off.)

Interior Comfort

## Climate Control System

### Air intake selector

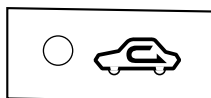

Outside or recirculated air positions can be selected. Press the switch to select outside/recirculated air positions.

#### **Recirculated air position (indicator light illuminated)**

Use this position when going through tunnels, driving in congested traffic (high engine exhaust areas) or when quick cooling is desired.

#### **Outside air position (indicator light turned off)**

Use this position for normal conditions and defogging.

### **⚠ WARNING**

**Do not use the  position in cold or rainy weather:**

*Using the  position in cold or rainy weather is dangerous as it will cause the windows to fog up. Your vision will be hampered, which could lead to a serious accident.*

### AMB (Ambient Temperature) switch



Press the AMB switch to display the ambient temperature.

#### **NOTE**

- *The displayed ambient temperature may vary from the actual ambient temperature depending on the surrounding area and vehicle conditions.*
- *Press the AMB switch 3 seconds or more to switch the display from Fahrenheit to Centigrade or vice versa.*
- *Press the AMB switch again to switch the display from ambient temperature to the temperature set for the air conditioner.*

### Windshield defroster switch

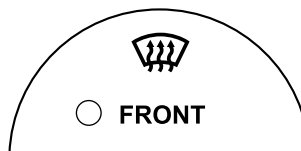

Press the switch to defrost the windshield and front door windows.

### **▼ Operation of Automatic Air Conditioning**

1. Press the AUTO switch. Selection of the airflow mode, air intake selector and amount of airflow will be automatically controlled.

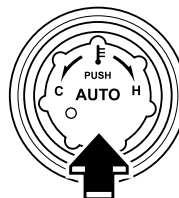

## Climate Control System

- Use the temperature control dial to select a desired temperature.

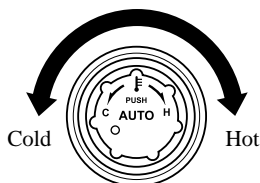



To turn off the system, press the OFF switch.

### NOTE

- Setting the temperature to maximum high or low will not provide the desired temperature at a faster rate.
- When selecting heat, the system will restrict airflow until it has warmed to prevent cold air from blowing out of the vents.

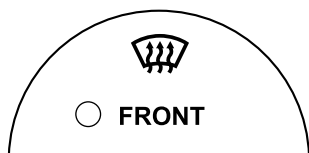
### ▼ Windshield Defrosting and Defogging



Press the windshield defroster switch. In this position, the  position is automatically selected, and the air conditioner automatically turns on. The air conditioner will directly dehumidify the air to the front windshield and side windows (page 6-4). Airflow amount will be increased.

### ⚠ WARNING

Set the temperature control to the hot or warm position when defogging ( position):

Using the  position with the temperature control set to the cold position is dangerous as it will cause the outside of the windshield to fog up. Your vision will be hampered, which could lead to a serious accident.

### NOTE

Use the temperature control dial to increase the air flow temperature and defog the windshield more quickly.

### ▼ Sunlight/Temperature Sensor

The fully automatic air conditioner function measures inside and outside temperatures, and sunlight. It then sets temperatures inside the passenger compartment accordingly.

### ⚠ CAUTION

Do not obstruct either sensor, otherwise the automatic air conditioner will not operate properly.

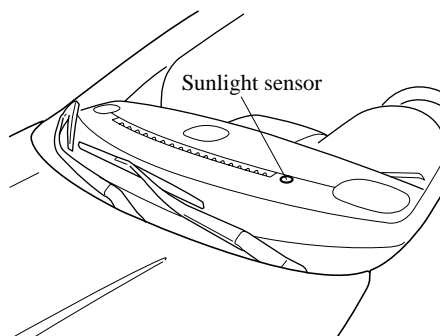

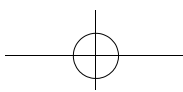

Interior Comfort

## Climate Control System

---

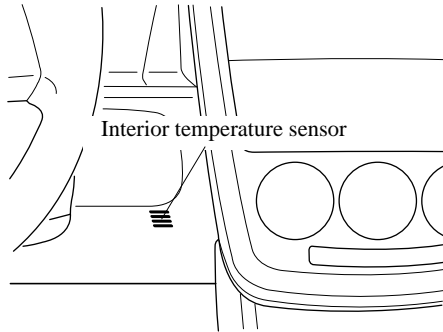

6-14

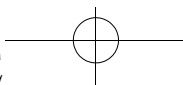

Interior Comfort  
**Audio System**

## Antenna

### ▼ Detachable Type

To remove the antenna, turn it counterclockwise.  
To install the antenna, turn it clockwise.  
Make sure the antenna is securely installed.

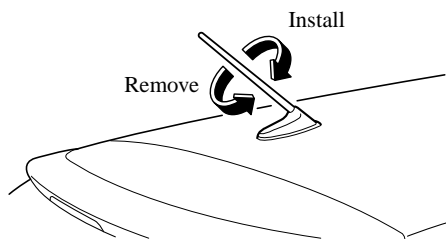

### **CAUTION**

- To prevent damage to the antenna, remove it before entering a car wash facility or passing beneath a low overhead clearance.
- Be careful around the antenna when removing snow from the roof. Otherwise the antenna could be damaged.

#### **NOTE**

When leaving your vehicle unattended, we recommend that you remove the antenna and store it inside the vehicle.

## Operating Tips for Audio System

### **WARNING**

**Do not adjust the audio control switches while driving the vehicle:**

*Adjusting the audio while driving the vehicle is dangerous as it could distract your attention from the vehicle operation which could lead to a serious accident. Always adjust the audio while the vehicle is stopped. Even if the audio control switches are equipped on the steering wheel, learn to use the switches without looking down at them so that you can keep your maximum attention on the road while driving the vehicle.*

### **CAUTION**

*For the purposes of safe driving, adjust the audio volume to a level that allows you to hear sounds outside of the vehicle.*

#### **NOTE**

- Do not use the audio for long periods of time while the engine is off. Otherwise the battery could go dead.
- If a cellular phone or CB radio is used in or near the vehicle, it could cause noise to occur from the audio system, however, this does not indicate that the system has been damaged.

Interior Comfort

## Audio System

### ▼ Radio Reception

#### AM characteristics

AM signals bend around such things as buildings or mountains and bounce off the ionosphere. Therefore, they can reach longer distances than FM signals. Because of this, two stations may sometimes be picked up on the same frequency at the same time.

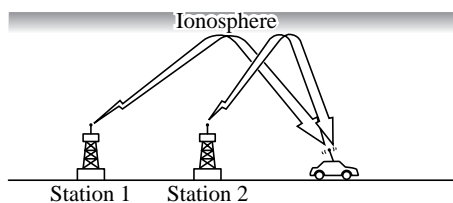

#### FM characteristics

An FM broadcast range is usually about 40—50 km (25—30 miles) from the source. Because of extra coding needed to break the sound into two channels, stereo FM has even less range than monaural (non-stereo) FM.

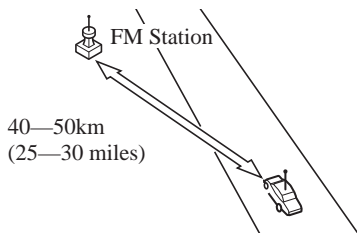

Signals from an FM transmitter are similar to beams of light because they do not bend around corners, but they do reflect. Unlike AM signals, FM signals cannot travel beyond the horizon. Therefore, FM stations cannot be received at the great distances possible with AM reception.

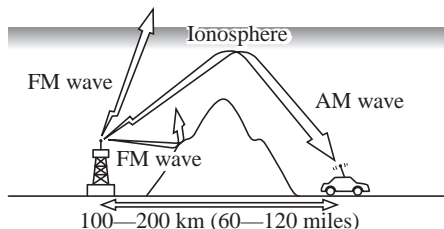

Atmospheric conditions can also affect FM reception. High humidity will cause poor reception. However, cloudy days may provide better reception than clear days.

#### **Multipath noise**

Since FM signals can be reflected by obstructions, it is possible to receive both the direct signal and the reflected signal at the same time. This causes a slight delay in reception and may be heard as a broken sound or a distortion. This problem may also be encountered when in close proximity to the transmitter.

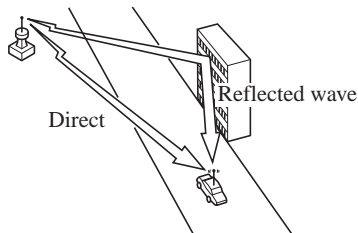

## Interior Comfort Audio System

### Flutter/Skip noise

Signals from an FM transmitter move in straight lines and become weak in valleys between tall buildings, mountains, and other obstacles. When a vehicle passes through such an area, the reception conditions may change suddenly, resulting in annoying noise.

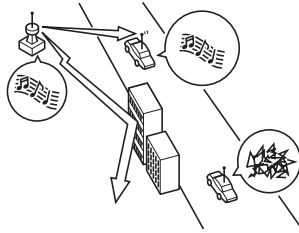

### Weak signal noise

In suburban areas, broadcast signals become weak because of distance from the transmitter. Reception in such fringe areas is characterized by sound breakup.

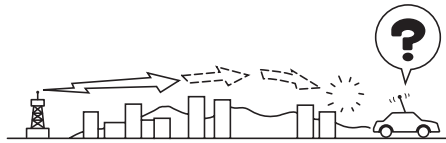

### Strong signal noise

This occurs very close to a transmitter tower. The broadcast signals are extremely strong, so the result is noise and sound breakup at the radio receiver.

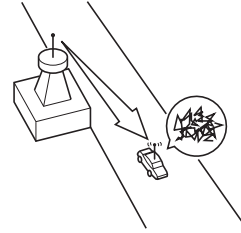

### Station drift noise

When a vehicle reaches the area of two strong stations broadcasting at similar frequencies, the original station may be temporarily lost and the second station picked up. At this time there will be some noise from this disturbance.

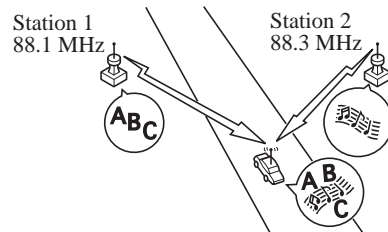

Interior Comfort

## Audio System

### ▼ Operating Tips for CD Player/In-Dash CD Changer

#### Condensation phenomenon

Immediately after turning on the heater when the vehicle is cold, the CD or optical components (prism and lens) in the CD player/In-dash CD changer may become clouded with condensation. At this time, the CD will eject immediately when placed in the unit. A clouded CD can be corrected simply by wiping it with a soft cloth. Clouded optical components will clear naturally in about an hour. Wait for normal operation to return before attempting to use the unit.

#### Handling the CD player/In-dash CD changer

The following precautions should be observed.

- Do not spill any liquid on the audio system.

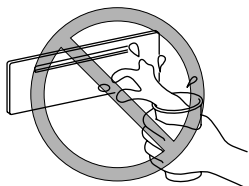

- Do not insert any objects, other than CDs, into the slot.

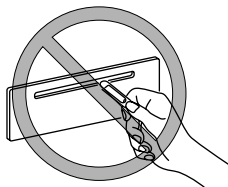

- The CD revolves at high speed within the unit. Defective (cracked or badly bent) CDs should never be used.

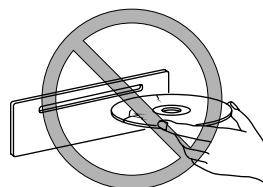

- Do not use non-conventional discs such as heart-shaped, octagonal discs, etc. The disc may not eject resulting in a malfunction.

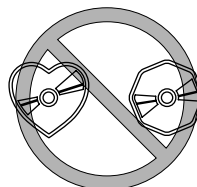

- If the memory portion of the CD is transparent or translucent, do not use the disc.

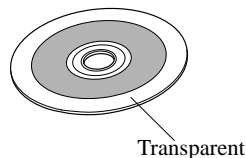



Interior Comfort  
**Audio System**

- A new CD may have rough edges on its inner and outer perimeters. If a disc with rough edges is used, proper setting will not be possible and the CD player/In-dash CD changer will not play the CD. In addition, the disc may not eject resulting in a malfunction. Remove the rough edges in advance by using a ball-point pen or pencil as shown below. To remove the rough edges, rub the side of the pen or pencil against the inner and outer perimeter of the CD.

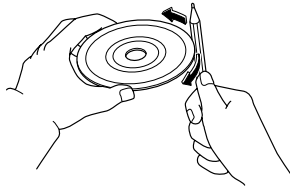

- When driving over uneven surfaces, the sound may jump.

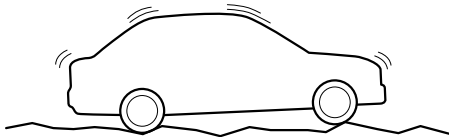

- The CD player/In-dash CD changer has been designed to play CDs bearing the identification logo as shown. No other discs can be played.
- Use discs that have been legitimately produced. If illegally-copied discs such as pirated discs are used, the system may not operate properly.

**CD Player**



**In-dash CD changer**



- Be sure never to touch the signal surface when handling the CDs. Pick up a CD by grasping the outer edge or the edge of the hole and the outer edge.

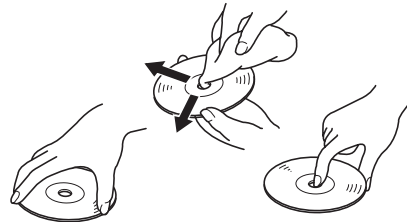

- Do not stick paper or tape on the CD. Avoid scratching the reverse side (the side without a label). The disc may not eject resulting in a malfunction.
- Dust, finger smudges, and dirt can decrease the amount of light reflected from the signal surface, thus affecting sound quality. If the CD should become soiled, gently wipe it with a soft cloth from the center of the CD to the edge.

Interior Comfort

## Audio System

- Do not use record sprays, antistatic agents, or household spray cleaners. Volatile chemicals such as benzine and thinner can also damage the surface of the CD and must not be used. Anything that can damage, warp, or fog plastic should never be used to clean CDs.
- Insert discs one by one. If two discs are inserted at the same time, the system may not operate properly.
- CD TEXT textual information cannot be displayed by audio units other than the In-dash CD changer (MP3 compatible type only). (Only playback is possible.)
- The following player can play MP3 files recorded in CD-ROM, CD-R, and CD-RW.
  - In-dash CD changer (MP3 compatible type only)
- The CD player/In-dash CD changer ejects the CD if the CD is inserted upside down. Also dirty and/or defective CDs may be ejected.
- An 8 cm (3 in) CD can be played in the CD player.

The In-dash CD changer is specially made for 12 cm (5 in) CDs.  
An 8 cm (3 in) CD can be played in the In-dash CD changer (MP3 compatible type only) if an 8 cm (3 in) CD adapter is used.  
If an 8 cm (3 in) CD adapter is not used, the In-dash CD changer (MP3 compatible type only) may be damaged. Always use a CD adapter.  
An 8 cm (3 in) CD cannot be played in the In-dash CD changer (MP3 non-compatible type only) even if an 8 cm (3 in) CD adapter is used.
- Do not insert cleaning discs in the CD player/In-dash CD changer.
- Do not insert any disc with a peel-off seal affixed to it.

### Handling the In-dash CD changer

- This unit may not be able to play certain CD-R/CD-RWs made using a computer or music CD recorder due to disc characteristics, scratches, smudges, dirt, etc., or due to dust or condensation on the lens inside the unit.
- Storing CDs in the vehicle exposed to direct sunlight or high temperature may damage the CD-R/CD-RWs, and make them unplayable.
- CD-R/CD-RW exceeding 700 MB cannot be played.
- This unit may not be able to play certain discs made using a computer due to the application (writing software) setting used. (For details, consult the store where the application was purchased.)
- It is possible that certain text data, such as titles, recorded on a CD-R/CD-RW may not be displayed when musical data (CD-DA) is playing.
- The period from when a CD-RW is inserted to when it begins playing is longer than a normal CD or CD-R.
- Completely read the instruction manual and cautions for CD-R/CD-RWs.
- Do not use discs with cellophane tape adhering, partially peeled off labels, or adhesive material exuding from the edges of the CD label. Also, do not use discs with a commercially-available CD-R label affixed. The disc may not eject resulting in a malfunction.

Interior Comfort  
**Audio System**

▼ **Operating tips for MP3**

**NOTE**

*Supply of this product only conveys a license for private, non-commercial use and does not convey a license nor imply any right to use this product in any commercial (i.e. revenue-generating) real time broadcasting (terrestrial, satellite, cable and/or any other media), broadcasting/streaming via the Internet, intranets and/or other networks or in other electronic content distribution systems, such as pay-audio or audio-on-demand applications. An independent license for such use is required. For details, please visit <http://www.mp3licensing.com>.*

- This audio system handles MP3 files that have been recorded on CD-R/CD-RW/CD-ROMs. Discs that have been recorded using the following formats can be played:
    - ISO 9660 level 1
    - ISO 9660 level 2
    - Joliet extended format
    - Romeo extended format
  - This unit handles MP3 files conforming to the MP3 format containing both header frames and data frames.
  - This unit can play multi-session recorded discs that have up to 40 sessions.
  - This unit can play MP3s with sampling frequencies of 16/22.05/24/32/44.1/48 kHz.
  - This unit can play MP3 files that have been recorded in bit rates of 8 kbps to 320 kbps. Nonetheless, to insure enjoyment of music with consistent sound quality, it is recommended to use discs that have been recorded at a bit rate of 128 kbps or more.
- If a disc has both music data (CD-DA) and MP3 files, playback of the two file types differs depending on how the disc was recorded.
  - Packet written discs cannot be played on this unit.
  - This unit does not play CDs recorded using MP3i (MP3 interactive), MP3 PRO and RIFF MP3 formats.

Interior Comfort

## Audio System

### About folders and files

- The order of hierarchy for MP3 files and folders during playback or other functions is from shallow to deep. The arrangement and playing order of a recorded disc containing MP3 files is as follows:
  - File number  
A numerical file number is assigned to each file in a folder in the order of hierarchy from shallow to deep.
  - Folder number  
A numerical folder number is assigned to each folder in the order of hierarchy from shallow to deep.

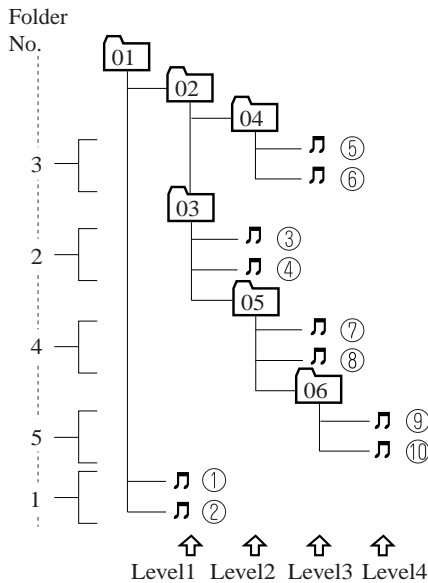

- The folder order is automatically assigned and this order cannot be optionally set.
- Any folder without an MP3 file will be ignored. (It will be skipped and the folder number will not be displayed.)

- MP3 files not conforming to the MP3 format containing both header frames and data frames will be skipped and not played.
- This unit will play MP3 files that have up to eight levels. However, the more levels a disc has, the longer it will take to initially start playing. It is recommended to record discs with two levels or less.
- A single disc with up to 512 files can be played and a single folder with up to 255 files can be played.
- When naming an MP3 file, be sure to add an MP3 file extension (.mp3) after the file name.
- The maximum number of characters that can be used for file names is as follows. However, this unit will only display up to 30 characters, including the file extension (.mp3).

	Maximum number of characters in a file name (including a separator "." and the three letters of the file extension)
ISO9660 level 1	12*
ISO9660 level 2	31*
Joliet extended format	64
Romeo extended format	128

\* English one-byte characters (capitalized only) and underbar "\_" are available.

### **CAUTION**

*This unit can only play MP3 files that have an MP3 file extension (.mp3) attached. Do not attach an MP3 file extension to any other type file as it could cause noise to be emitted or a malfunction in the unit.*

Interior Comfort  
**Audio System**

**About ID3 Tag display**

- This unit can only display ID3 Tag album, track and artist names that have been input using Ver.1.0/1.1/2.2/2.3 formats. Any other data that may have been input cannot be displayed.
- This unit can only display English (including numerals) one-byte characters. Use only English (including numerals) one-byte characters when inputting ID3 tags. Two-byte characters and some special symbols cannot be displayed.

**Specialized glossary**

**MP3**

Abbreviation for “MPEG Audio Layer 3”. A technical standard for audio compression as decided by an ISO (International Organization for Standardization) MPEG working group. Use of MP3 allows for audio data to be compressed to approximately a tenth of the source data size.

**ISO 9660**

An international standard for logical formatting of CD-ROM files and folders. It is divided into three separate levels based on differences in file naming procedures, data configuration and other characteristics.

**Multi-session**

A session is the complete amount of data recorded from the beginning to the end of a single period of CD-ROM, CD-R/CD-RW data recording. Multi-session refers to the existence of data from two or more sessions on a single disc.

**Sampling**

Refers to the process of encoding analog audio data at regular intervals and converting it to digital data. The sampling rate refers to the number of times a sample is taken in one second and is expressed in Hz units. Increasing the sampling rate improves the sound quality but also increases the data size.

**Bit rate**

Refers to the volume of data per second, expressed in bps (bits per second). Generally, the larger the number of the transfer bit rate when compressing an MP3 file, the more information regarding musical reproduction it carries, and therefore the better the sound quality.

**Packet writing**

A general term for the method, similar to that used for floppy discs or hard drives, of recording the required file in a single increment on a CD-R and similar.

**ID3 Tag**

ID3 tag is a method for storing information related to the music in an MP3 file. Information such as track, artist and album name can be stored. This content can be freely edited using ID3 editing function software.

**VBR**

Abbreviation for Variable Bit Rate. While CBR (Constant Bit Rate) is generally used, VBR varies the bit rate for audio compression according to compression conditions and this allows for compression with preference given to sound quality.

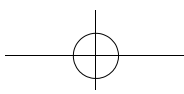

# MEMO

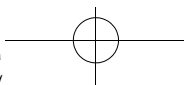
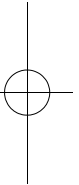
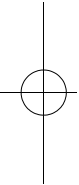

Interior Comfort  
**Audio System**

**Audio Set**

- Audio information is displayed on the information display.
- There are two types of In-dash CD changers. Check which In-dash CD changer your vehicle is equipped with.

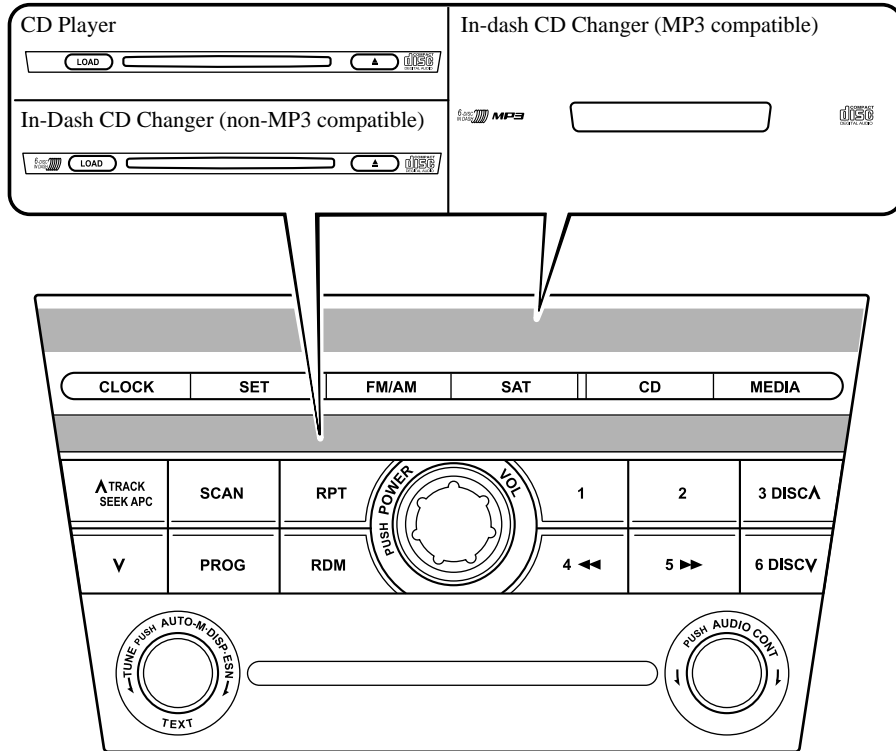

Power/Volume/Sound Controls ..... page 6-26  
 Operating the Radio ..... page 6-30  
 Operating the Compact Disc (CD) Player ..... page 6-34  
 Operating the In-Dash CD Changer ..... page 6-36  
 Error Indications ..... page 6-41

## Interior Comfort Audio System

### ▼ Power/Volume/Sound Controls

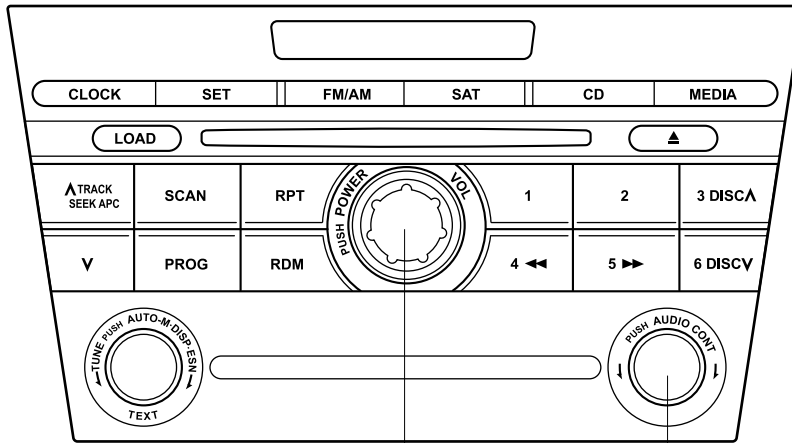

Power/Volume dial

Audio control dial

#### **Power ON/OFF**

Turn the ignition switch to the ACC or ON position.

Press the power/volume dial to turn the audio system on.

Press the power/volume dial again to turn the audio system off.

#### **NOTE**

*To prevent the battery from being discharged, do not leave the audio system on for a long period of time when the engine is not running.*

#### **Volume adjustment**

To adjust the volume, turn the power/volume dial.

Turn the power/volume dial to the right to increase volume, to the left to decrease it.

#### **Audio sound adjustment**

1. Press the audio control dial to select the function. The selected function will be indicated.

#### **Standard audio-equipped model**



\* Depending on the mode selected, the indication changes.



Interior Comfort  
**Audio System**

**Bose® Sound System-equipped model**

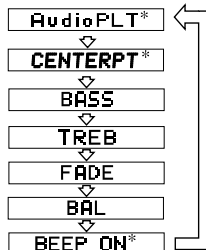

\* Depending on the mode selected, the indication changes.

- Turn the audio control dial to adjust the selected functions as follows:

**Standard audio-equipped model**

Indication	Turn Left	Turn Right
<b>ALC</b>	Select mode	
<b>BASS</b>	Decrease bass	Increase bass
<b>TREB</b>	Decrease treble	Increase treble
<b>FADE</b>	Shift the sound to the front	Shift the sound to the rear
<b>BAL</b>	Shift the sound to the left	Shift the sound to the right
<b>BEEP</b>	OFF	ON

**Bose® Sound System-equipped model**

Indication	Turn Left	Turn Right
<b>AudioPLT</b>	OFF	ON
<b>CENTERPT</b>	OFF	ON
<b>BASS</b>	Decrease bass	Increase bass
<b>TREB</b>	Decrease treble	Increase treble
<b>FADE</b>	Shift the sound to the front	Shift the sound to the rear
<b>BAL</b>	Shift the sound to the left	Shift the sound to the right
<b>BEEP</b>	OFF	ON

**NOTE**

About 5 seconds after selecting any mode, the volume function will be automatically selected. To reset bass, treble, fade, and balance, press the audio control dial for 2 seconds. The unit will beep and "CLEAR" will be displayed.

**Automatic Level Control (ALC)**

**(Standard audio-equipped model)**

The automatic level control is a feature that automatically adjusts audio volume and sound quality according to the vehicle speed.

The volume increases in accordance with the increase in vehicle speed, and decreases as vehicle speed decreases.

Interior Comfort  
**Audio System**

The following four modes are available. Select the desired mode.

Mode	Volume change
ALC OFF	No change
ALC LEVEL 1	Minimum
ALC LEVEL 2	Medium
ALC LEVEL 3	Maximum

Turn the audio control dial to select ALC OFF or ALC LEVEL1—3 modes. The selected mode will be indicated.

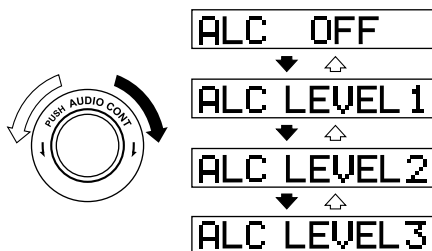

**\*AudioPilot® (Bose® Sound System-equipped model)**

AudioPilot automatically adjusts audio volume and sound quality in accordance with the level of noise entering the vehicle interior while driving. When AudioPilot is turned ON, the system automatically calculates the conditions for optimum hearing of sound which may be difficult to hear depending on exterior noise.

\* AudioPilot® is a registered trademark of Bose Corporation.

**\*Centerpoint® (Bose® Sound System-equipped model)**

Centerpoint offers you the experience of 5.1-channel surround sound in your vehicle even with your conventional 2-channel stereo CDs.

The true surround sound effect of Centerpoint can be adjusted to any one of five level between minimum and maximum enhancement.

Indication	Enhance level
CENTERPT MIN	Minimum
CENTERPT LOW	Low
CENTERPT MID	Medium
CENTERPT HI	High
CENTERPT MAX	Maximum

1. Turn the audio control dial and select CENTERPT ON.
2. Press the audio control dial and select the surround effect mode.
3. Turn the audio control dial to select CENTERPT MIN—MAX mode. The selected mode will be indicated.

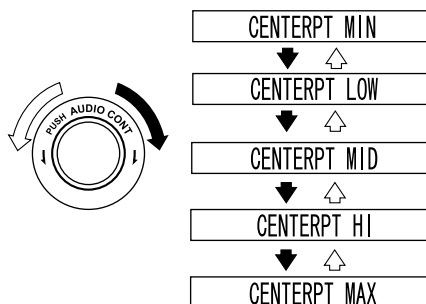

Interior Comfort  
**Audio System**

---

**NOTE**

- *Centerpoint<sup>®</sup> operates optimally with a 2-channel stereo CD. MP3 audio files can be played, however, MP3 audio files encoded with high compression may result in poor sound quality.*
  - *Centerpoint<sup>®</sup> is available for 2-channel stereo audio except for AM radio/FM radio/SIRIUS digital satellite radio.*
- \* Centerpoint<sup>®</sup> is a registered trademark of Bose Corporation.

**BEEP setting**

The beep-sound when operating the audio system can be set on or off.

## Interior Comfort Audio System

### ▼ Operating the Radio

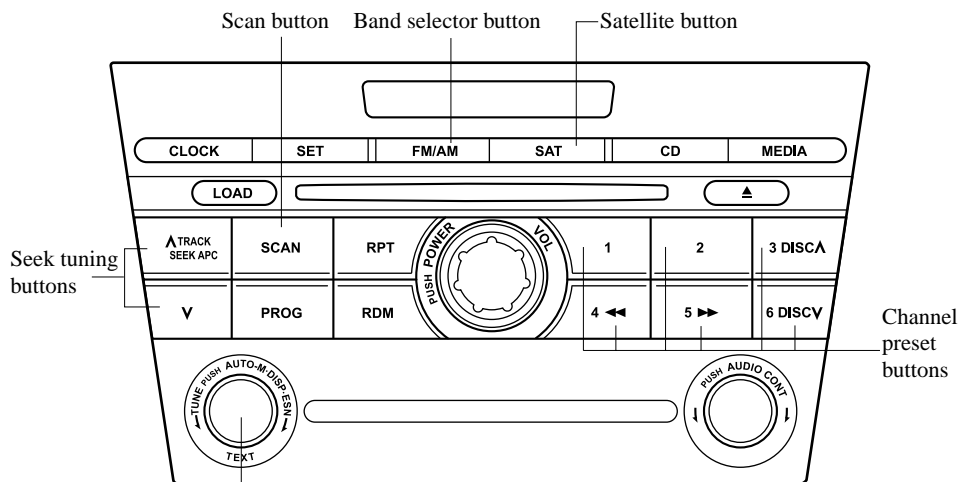

Manual tuning dial/Auto memory button/Electric serial number

#### **Radio ON**

Press a band selector button (**FM/AM**) to turn the radio on.

#### **Band selection**

Successively pressing the band selector button (**FM/AM**) switches the bands as follows: FM1→FM2→AM.

The selected mode will be indicated. If FM stereo is being received, "ST" will be displayed.

#### **NOTE**

*If the FM broadcast signal becomes weak, reception automatically changes from STEREO to MONO for reduced noise, and the "ST" indicator will go out.*

#### **Tuning**

The radio has the following tuning methods: Manual, Seek, Scan, Preset channel, and Auto memory tuning. The easiest way to tune stations is to set them on preset channels.

#### **NOTE**

*If the power supply is interrupted (fuse blows or the battery is disconnected), the preset channels will be canceled.*

#### **Manual tuning**

Turning the manual tuning dial will change the frequency higher or lower.

#### **Seek tuning**

Pressing the seek tuning button (**Λ**, **V**) will cause the tuner to seek a higher or lower frequency automatically.

Interior Comfort  
**Audio System**

**NOTE**

*If you continue to press and hold the button, the frequency will continue changing without stopping.*

**Scan tuning**

Press the scan button (**SCAN**) to automatically sample strong stations. Scanning stops at each station for about 5 seconds. To hold a station, press the scan button (**SCAN**) again during this interval.

**Preset channel tuning**

The 6 preset channels can be used to store 6 AM and 12 FM stations.

1. To set a channel first select AM, FM1, or FM2. Tune to the desired station.
2. Depress a channel preset button for about 2 seconds until a beep sound is heard. The preset channel number and station frequency will be displayed. The station is now held in the memory.
3. Repeat this operation for the other stations and bands you want to store. To tune one in the memory, select AM, FM1, or FM2 and then press its channel preset button. The station frequency and the channel number will be displayed.

**NOTE**

*If the power supply is interrupted (fuse blows or the battery is disconnected), the preset channels will be canceled.*

**Auto memory tuning**

This is especially useful when driving in an area where the local stations are not known. Additional AM/FM stations can be stored without disturbing the previously set channels.

Press and hold the auto memory button (**AUTO-M**) for about 2 seconds until a beep sound is heard; the system will automatically scan and temporarily store up to 6 stations with the strongest frequencies in each selected band in that area.

After scanning is completed, the station with the strongest frequency will be tuned and its frequency displayed.

Press and release the auto memory button (**AUTO-M**) to recall stations from the auto-stored stations. One stored station will be selected each time; its frequency and channel number will be displayed.

**NOTE**

*If no stations can be tuned after scanning operations, "A" will be displayed.*

**SATELLITE RADIO (SAT)**

Vehicles equipped with the separately purchased SIRIUS digital satellite radio unit have the ability to receive channels of digital quality programming coast to coast via satellite. For information on use, read the Satellite Radio Kit manual accompanying the SIRIUS digital satellite radio unit. A subscription to SIRIUS digital satellite radio service is required (available in the U.S. - Except Alaska and Hawaii) to enable this feature once the separately purchased SIRIUS digital satellite radio unit has been installed. For subscription and channel information, or for digital satellite radio technical issues, contact SIRIUS directly at:

- Web: [www.siriusradio.com](http://www.siriusradio.com)
- Phone (24 hrs/day, 7 days/week): 888-539-SIRI (7474)
- E-mail: [customercare@sirius-radio.com](mailto:customercare@sirius-radio.com)
- Mailing Address: Sirius Satellite Radio

Interior Comfort

## Audio System

---

1221 Avenue Of The Americas  
New York, NY 10020  
Attention: Customer Care

Include your Sirius Radio ESN  
(Electronic Serial Number) when  
subscribing or requesting technical  
assistance. See the Satellite Radio Kit  
manual accompanying the SIRIUS unit  
for complete satellite radio activation  
procedures and information on how to  
display the ESN#.

6-32

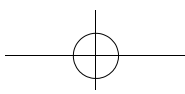

# MEMO

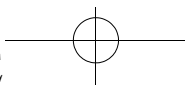
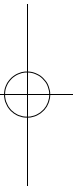
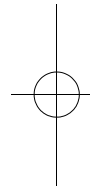

Interior Comfort  
**Audio System**

▼ **Operating the Compact Disc (CD) Player \***

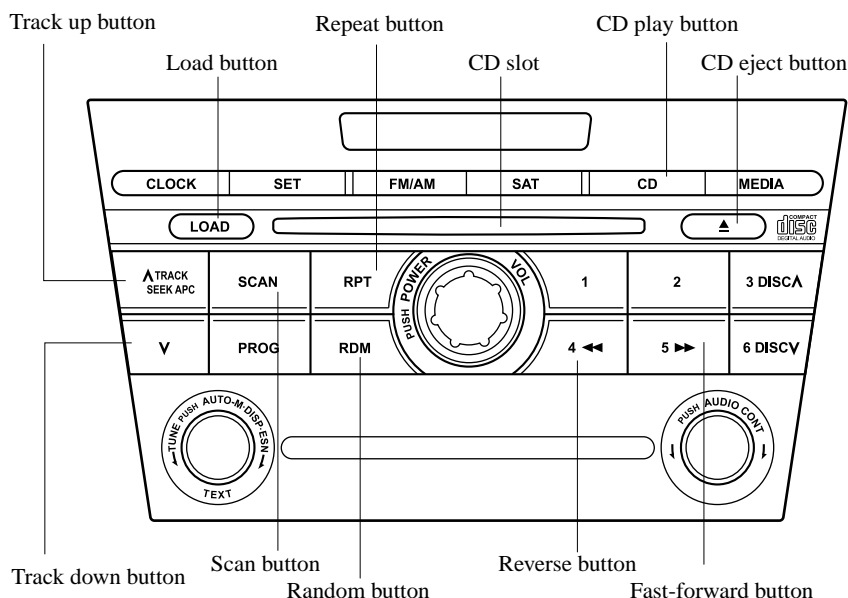

Type	Playable data
Music CD player (non-MP3 compatible)	Music data (CD-DA)

**Inserting the CD**

Insert the CD into the slot, label-side up. The auto-loading mechanism will set the CD and begin play. There will be a short lapse before play begins while the player reads the digital signals on the CD.

**Ejecting the CD**

Press the CD eject button (▲) to eject the CD.

**Playback**

Press the CD play button (CD) to start play when a CD is in the unit. If a CD is not in the unit when the CD play button (CD) is pressed, "NO DISC" will flash on and off.

**NOTE**

When the load button (LOAD) is pressed, the CD will load and play even if the CD eject button (▲) had been previously pressed.

**Fast-forward/Reverse**

Press and hold the fast-forward button (▶▶) to advance through a track at high speed.

Press and hold the reverse button (◀◀) to reverse through a track at high speed.

**Track search**

Press the track up button (▲) once to skip forward to the beginning of the next track. Press the track down button (▼) once to skip back to the beginning of the current track.



Interior Comfort  
**Audio System**

---

**Music scan**

This feature helps to find a program by playing about the first 10 seconds of each track.

Press the scan button (**SCAN**) during playback to start the scan play operation (the track number will flash).  
Press the scan button (**SCAN**) again to cancel scan playback.

***NOTE***

*If the unit is left in scan, normal playback will resume where scan was selected.*

**Repeat playback**

This feature makes it possible to listen to a selection repeatedly.

Press the repeat button (**RPT**) during playback. The current selection will be repeated (“RPT” will be displayed).  
Press the repeat button (**RPT**) once again to cancel repeat playback.

**Random playback**

This feature allows the CD player to randomly select the order of the songs.

Press the random button (**RDM**) during playback. The next selection will be randomly selected (“RDM” will be displayed).  
Press the random button (**RDM**) once again to cancel random playback.

**Message display**

If “CHECK CD” is displayed, it means that there is some CD malfunction. Check the CD for damage, dirt, or smudges, and then properly reinsert. If the message appears again, take the unit to an Authorized Mazda Dealer for service.

Interior Comfort  
**Audio System**

▼ **Operating the In-Dash CD Changer\***

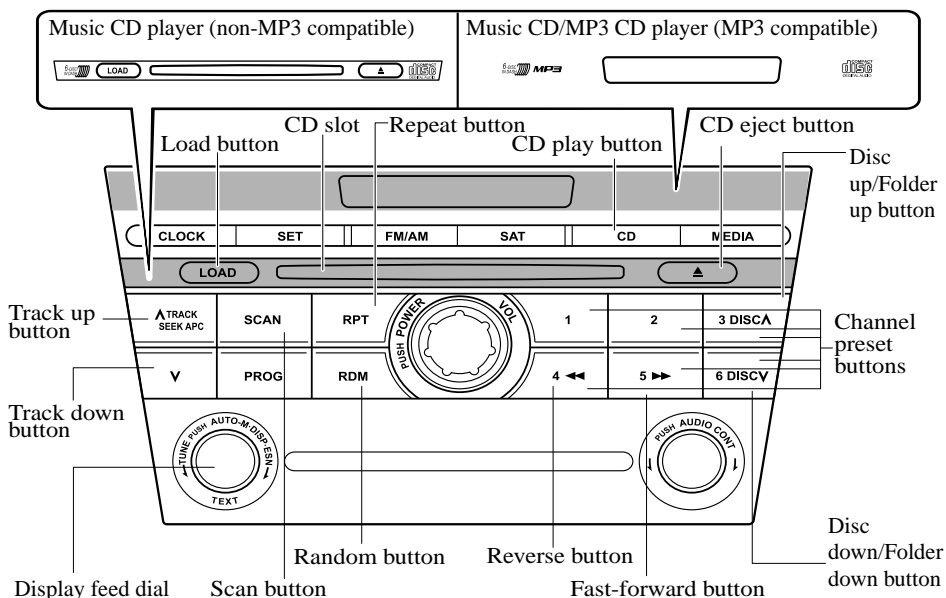

There are two types of In-dash CD changers. Check which In-dash CD changer your vehicle is equipped with.

Type	Playable data
Music CD player (non-MP3 compatible)	· Music data (CD-DA)
Music CD/MP3 CD player (MP3 compatible)	· Music data (CD-DA) · MP3 file

**NOTE**

If a disc has both music data (CD-DA) and MP3 files, playback of the two file types differs depending on how the disc was recorded.

**Inserting the CD**

The CD must be label-side up when inserting. The auto-loading mechanism will set the CD and begin play. There will be a short lapse before play begins while the player reads the digital signals on the CD.

The disc number and the track number will be displayed.

**NOTE**

The CD will begin playback automatically after insertion. A CD cannot be inserted while the display reads "WAIT". A beeping sound can be heard during this waiting time. Simultaneously pressing the power/volume dial and the load button (LOAD) for about 2 seconds will turn this beeping sound ON or OFF.

Interior Comfort  
**Audio System**

**Normal insertion**

1. Press the load button (LOAD ).
2. When “IN” is displayed, insert the CD.

**Inserting CDs into desired tray number**

1. Press and hold the load button (LOAD ) for about 2 seconds until a beep sound is heard.
2. Press the channel preset button for the desired tray number while “WAIT” is displayed.
3. When “IN” is displayed, insert the CD.

**NOTE**

*The CD cannot be inserted to the desired tray number if the number is already occupied.*

**Multiple insertion**

1. Press and hold the load button (LOAD ) for about 2 seconds until a beep sound is heard.
2. When “IN” is displayed, insert the CD.
3. When “IN” is displayed again, insert the next CD.

**NOTE**

*The first-inserted CD will be played automatically when:*

- No other CD is inserted within 15 seconds after “IN” is displayed.
- The CD trays are full.

**Displaying the CD-inserted tray number**

When you want to know the number for a CD-inserted tray, press the display button (DISP ). The tray number will be displayed for 5 seconds.

**Ejecting the CD**

**Normal ejection**

1. Press the CD eject button (▲ ). The disc number and “DISC OUT” will be displayed.
2. Pull out the CD.

**NOTE**

*When the CD is ejected during play, the next CD will be played automatically.*

**Ejecting CDs from desired tray number**

1. Press and hold the CD eject button (▲ ) for about 2 seconds until a beep sound is heard. The “DISC OUT” display flashes.
2. Press the channel preset button for the desired CD number for less than 5 seconds after the beep sound is heard.
3. Pull out the CD.

**Multiple ejection**

1. Press and hold the CD eject button (▲ ) for about 2 seconds until a beep sound is heard. The “DISC OUT” display flashes.
2. Press the CD eject button (▲ ) again for less than 5 seconds after the beep sound is heard.

**NOTE**

*If the button is not pressed and about 5 seconds have elapsed while “DISC OUT” is flashing, CDs are automatically ejected.*

3. Pull out the CD, then the next CD will be ejected.

Interior Comfort

## Audio System

### **NOTE**

- CDs will be ejected starting with the one with the lowest number.
- All CDs in the tray will be ejected continuously.
- CDs can be ejected when the ignition switch is off. Press and hold the CD eject button (▲) for about 2 seconds and all CDs will eject.

### **Playback**

Press the CD play button (CD) to start play when a CD is in the unit.

If a CD is not in the unit when the CD play button (CD) is pressed, "NO DISC" will flash on and off.

### **Fast-forward/Reverse**

Press and hold the fast-forward button (▶▶) to advance through a track at high speed.

Press and hold the reverse button (◀◀) to reverse through a track at high speed.

### **Track search**

Press the track up button (Λ) once to skip forward to the beginning of the next track. Press the track down button (V) once to skip back to the beginning of the current track.

### **Disc search**

#### **During music CD playback**

To change the disc, press the DISC button (DISCΛ or DISCV) during playback.

#### **During MP3 CD playback**

To change the disc, press the DISC button (DISCΛ or DISCV) for 1.5 seconds or more during playback.

### **Folder search (during MP3 CD playback)**

To change to the previous folder, press the folder down button (DISCV) for less than 1.5 seconds, or press the folder up button (DISCΛ) for less than 1.5 seconds to advance to the next folder.

### **Music scan**

This feature helps to find a program by playing about the first 10 seconds of each track.

Press the scan button (SCAN) during playback to start the scan play operation (the track number will flash).

Press the scan button (SCAN) again to cancel scan playback.

### **NOTE**

If the unit is left in scan, normal playback will resume where scan was selected.

### **Repeat playback**

#### **During music CD playback**

1. Press the repeat button (RPT) during playback to play the current track repeatedly. "RPT" is displayed.
2. Press the button again to cancel the repeat playback.

#### **During MP3 CD playback**

##### **(Track repeat)**

1. Press the repeat button (RPT) during playback to play the current track repeatedly. "RPT" is displayed.
2. To cancel the repeat playback, press the button again after 3 seconds.

Interior Comfort  
**Audio System**

**(Folder repeat)**

1. Press the repeat button (**RPT**) during playback, and then press the button again within 3 seconds to play the tracks in the current folder repeatedly. "RPT" is displayed.
2. Press the button again to cancel the repeat playback.

**Random playback**

Tracks are randomly selected and played.

**During music CD playback**

1. Press the random button (**RDM**) during playback to play the tracks in the CD randomly. "RDM" is displayed.
2. Press the button again to cancel the random playback.

**During MP3 CD playback**

**(Folder random)**

1. Press the random button (**RDM**) during playback to play the tracks in the folder randomly. "RDM" is displayed.
2. To cancel the random playback, press the button again after 3 seconds.

**(CD random)**

1. Press the random button (**RDM**) during playback, and then press the button again within 3 seconds to play the tracks on the CD randomly. "RDM" is displayed.
2. Press the button again to cancel the random playback.

**Switching the display (MP3 compatible type)**

Each time the display button (**DISP**) is pressed during playback, the display will switch in the following order.

**Music CD**



Track number/Elapsed time display  
↓  
Disc tray number  
↓  
File name display  
↓  
Album name display  
↓  
Artist name display

**MP3 CD**



Disc number/File number/Elapsed time display  
↓  
Disc tray number  
↓  
Folder number/Track number  
↓  
File name  
↓  
Folder name  
↓  
Album name (ID3 Tag)  
↓  
Song name (ID3 Tag)  
↓  
Artist name (ID3 Tag)

**NOTE  
(MP3 CD)**

*This unit can only read English (including numerals) one-byte characters. Depending on the CD writing software used, proper display may not be possible.*

Interior Comfort

## Audio System

---

### **Display scroll (MP3 compatible type)**

Only 12 characters can be displayed at one time. To display the rest of the characters of a long title, turn the display feed dial (**TEXT**) to the right. Hidden titles can be scrolled into the display one character at a time.

### ***NOTE***

*The displayable number of characters is limited. If the number of characters, including the file extension (.mp3), exceeds 32 characters, it may not be fully displayed.*

### **Message display**

If “CHECK CD” is displayed, it means that there is some CD malfunction. Check the CD for damage, dirt, or smudges, and then properly reinsert. If the message appears again, take the unit to an Authorized Mazda Dealer for service.

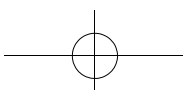

Interior Comfort  
**Audio System**

---

**▼ Error Indications**

If you see an error indication on the display, find the cause in the chart. If you cannot clear the error indication, take the vehicle to an Authorized Mazda Dealer.

Indication	Cause	Solution
CHECK CD	CD is inserted upside down	Insert the CD properly. If the error indication does not disappear, consult an Authorized Mazda Dealer
	CD is defective	Insert another CD properly. If the error indication does not disappear, consult an Authorized Mazda Dealer

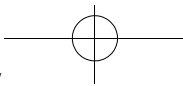
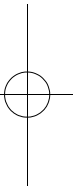
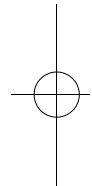

Interior Comfort

## Audio System

### Audio Control Switch Operation (Steering Wheel)\*

When the audio unit is turned on, operation of the audio unit from the steering wheel is possible.

#### NOTE

Because the audio unit will be turned off under the following conditions, the switches will be inoperable.

- When the ignition switch is turned to the LOCK position.
- When the power button on the audio unit is pressed and the audio unit is turned off.
- When CD being played is ejected. (For the In-dash CD changer, when all CDs are ejected.)

#### Without navigation system

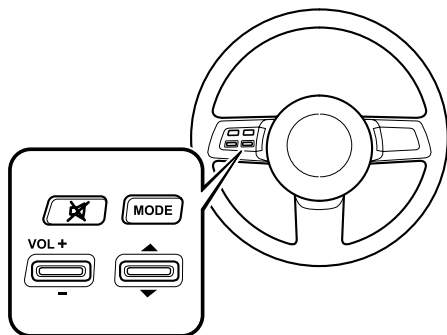

#### With navigation system

Use the VOICE switch for navigation system sound operation.

For details, refer to the separate manual "NAVIGATION SYSTEM".

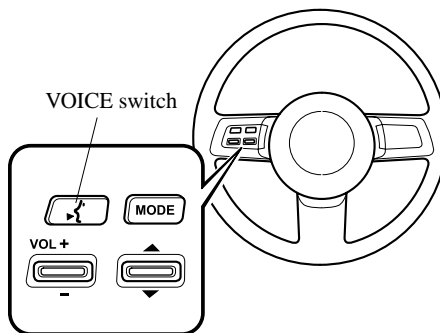

#### NOTE

- The VOICE switch is operable with the audio unit turned off.
- Mazda has installed this system to prevent distraction while driving the vehicle and using audio controls on the dashboard. Always make safe driving your first priority.

#### ▼ Adjusting the Volume

To increase the volume, pull up the volume switch.

To decrease the volume, press down the volume switch.

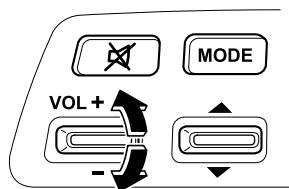



Interior Comfort  
**Audio System**

▼ **Changing the Source**

Press the mode switch (MODE) to change the audio source (FM1 radio> FM2 radio> AM radio> CD player or CD changer> SIRIUS1> SIRIUS2> SIRIUS3> cyclical).

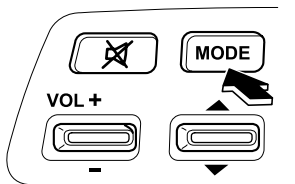

**NOTE**

*CD, CD changer, and SIRIUS digital satellite radio modes cannot be selected in the following cases:*

- *CD, CD changer, or SIRIUS digital satellite radio unit is not equipped on the audio system.*
- *CD has not been inserted.*

▼ **Seek Switch**

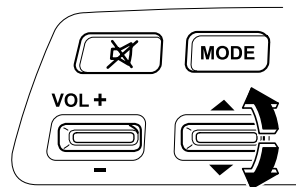

**When listening to the radio**

Pull up or press down the seek switch, the radio switches to the next/previous stored station in the order that it was stored (1—6).

Pull up or press down the seek switch for about 2 seconds until a beep sound is heard to seek all usable stations at a higher or lower frequency whether programmed or not.

**When playing a CD**

Pull up the seek switch to skip to the next track.

Press down the seek switch to repeat the current track.

▼ **Mute Switch**

Press the mute switch (marked with a crossed-out speaker icon) once to mute audio, press it again to resume audio output.

**NOTE**

*If the ignition switch is turned to the LOCK position with the audio muted, the mute will be canceled.*

*Therefore, when the engine is restarted, the audio is not muted. To mute the audio again, press the mute switch (marked with a crossed-out speaker icon).*

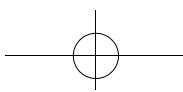

Interior Comfort  
**Audio System**

---

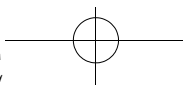
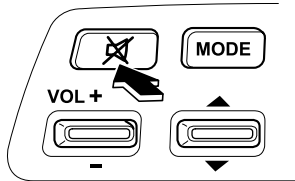

Interior Comfort  
**Audio System**

## Safety Certification

This CD player is made and tested to meet exacting safety standards. It meets FCC requirements and complies with safety performance standards of the U.S. Department of Health and Human Services.

### **CAUTION**

- *This CD player should not be adjusted or repaired by anyone except qualified service personnel.  
If servicing is required, contact an Authorized Mazda Dealer.*
- *Use of controls or adjustments or performance of procedures other than those specified herein may result in hazardous laser exposure. Never operate the CD player with the top case of the unit removed.*
- *Changes or modifications not expressly approved by the party responsible for compliance could void the user's authority to operate this equipment.*

### **NOTE**

*For CD player section:*

*This device complies with part 15 of the FCC Rules. Operation is subject to the following two conditions: (1) This device may not cause harmful interference, and (2) this device must accept any interference received, including interference that may cause undesired operation.*

### **NOTE**

*This equipment has been tested and found to comply with the limits for a Class B digital device, pursuant to part 15 of the FCC Rules. These limits are designed to provide reasonable protection against harmful interference in a residential installation. This equipment generates, uses, and can radiate radio frequency energy and, if not installed and used in accordance with the instructions, may cause harmful interference to radio communications. However, there is no guarantee that interference will not occur in a particular installation.*

Interior Comfort

## Interior Equipment

### Sunvisors

When you need a sunvisor, lower it for use in front or swing it to the side.

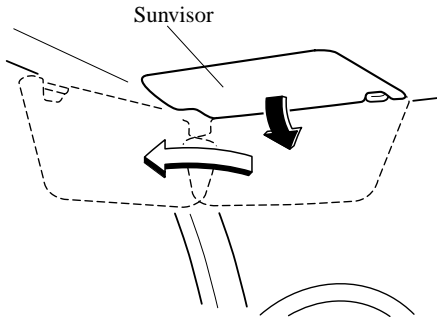

### ▼ Side Extension Sunvisors

The visor extender extends the sunvisor's range of sun shading. To use, pull it out.

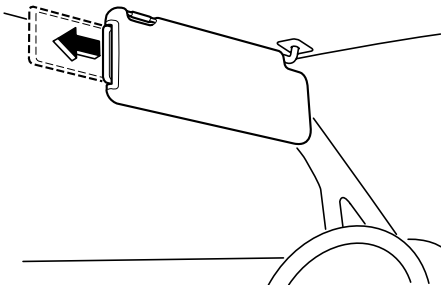

### **⚠ CAUTION**

*When moving the sunvisor, reinsert the visor extender, otherwise the visor extender could hit the rearview mirror.*

### ▼ Vanity Mirrors

To use the vanity mirror, lower the sunvisor.

## Interior Equipment

### Interior Lights

#### ▼ Illuminated Entry System

When the illuminated entry system operates, the overhead light (switch is in the DOOR position) turn on for:

- About 30 seconds after the driver's door is unlocked and the ignition switch is in the LOCK position (with the ignition key removed).
- About 15 seconds after all doors are closed (If your vehicle is equipped with the advanced key, the overhead light turns on for about 5 seconds when the advanced key is outside of the vehicle).
- About 15 seconds after the ignition switch is in the LOCK position (with the ignition key removed) with all doors closed.

The light also turns off when:

- The ignition switch is turned to the ON position and all doors are closed.
- The driver's door is locked.

#### **NOTE**

##### **Battery saver**

*If any door is left opened, the light goes out after about 30 minutes to save the battery. The light turns on again when the ignition switch is turned to the ON position, or when any door is opened after all doors have been closed.*

#### ▼ Overhead Lights

##### Front

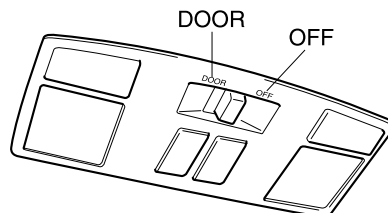

Switch Position	Front Overhead Lights
OFF	Light off
DOOR	<ul style="list-style-type: none"> <li>• Light is on when any door is open</li> <li>• Light is on or off when the illuminated entry system is on</li> </ul>

##### Rear

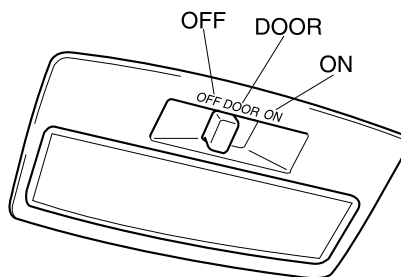

Switch Position	Rear Overhead Lights
OFF	Light off
DOOR	Light is on when any door is open
	Light is on or off when the illuminated entry system is on
ON	Light on

Interior Comfort

## Interior Equipment

### ▼ Map Lights

The map lights are switched on or off by pressing the switches.

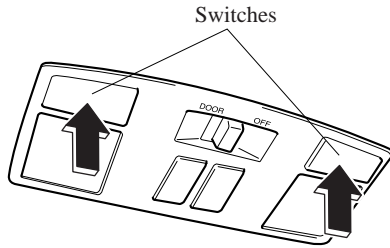

### ▼ Luggage Compartment Light

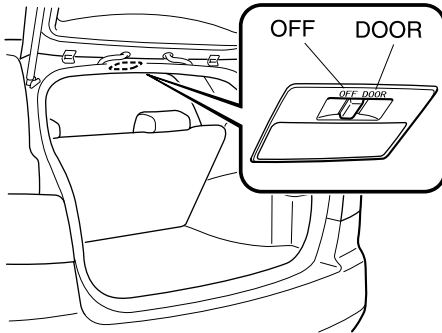

Switch Position	Luggage Compartment Light
OFF	Light off
DOOR	Light on when the liftgate is open

Interior Comfort  
**Interior Equipment**

**Information Display**

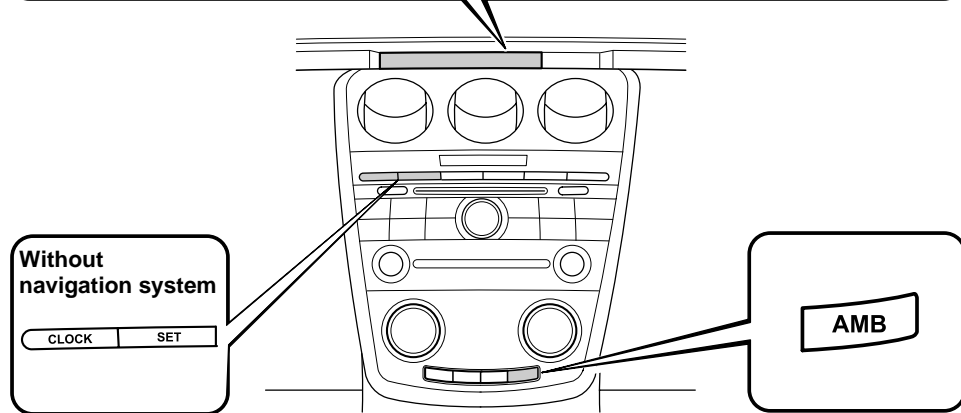
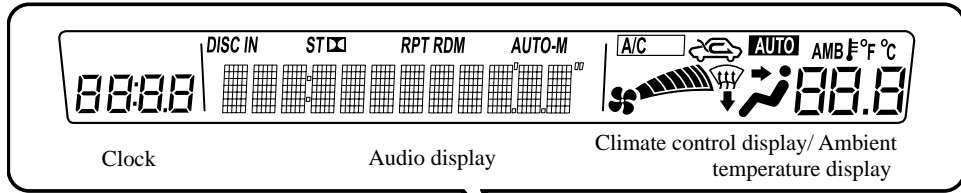

▼ **Information Display Functions**

The information display has the following functions:

- Clock
- Ambient Temperature Display (Outside Temperature Display, Fully Automatic Type)
- Climate Control Display (Fully Automatic Type)
- Audio Display

Interior Comfort

## Interior Equipment

### ▼ Clock

When the ignition switch is in the ACC or ON position, the time is displayed.



#### Without navigation system

##### Time setting

1. Press the CLOCK switch until a beep sounds, and “12Hr” and “24Hr” will be displayed.
2. Press the SET switch to switch between “12Hr” and “24Hr” displays. The selected display will flash. To select the desired clock setting, press the CLOCK switch again while the preferred setting is flashing.
3. “Hr. ADJUST” will be displayed next, and the hour portion of the display will flash. Press the SET switch to set the hour, then press the CLOCK switch.
4. “Min. ADJUST” will be displayed next, and the minutes portion of the display will flash. Press the SET switch to set the minutes, then press the CLOCK switch.

### Time resetting

While the clock is displayed, press the SET switch 1.5 seconds or more. When the switch is released, a beep will sound and the clock will be reset as follows:

(Example)

12:01—12:29→12:00

12:30—12:59→1:00

#### **NOTE**

*When the SET switch is released, the seconds are reset to “00”.*

#### With navigation system

Refer to “NAVIGATION SYSTEM”.

#### **NOTE**

*Minutes and seconds are adjusted by the GPS, however, it is necessary to adjust hours under the following conditions:*

- Driving across different time zones
- Daylight saving time start and end

### ▼ Ambient Temperature Display (Fully Automatic Type)

When the ignition switch is in the ON position, press the AMB switch to display the ambient temperature.

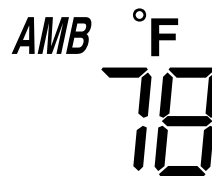



## Interior Equipment

### NOTE

- Under the following conditions, the ambient temperature display may differ from the actual ambient temperature depending on the surroundings and vehicle conditions:
  - Significantly cold or hot temperatures.
  - Sudden changes in ambient temperature.
  - The vehicle is parked.
  - The vehicle is driven at low speeds.
- Press the AMB switch a few seconds or more to switch the display from Fahrenheit to Centigrade or vice versa.
- **(With fully automatic climate control system)**  
Press the AMB switch again to switch the display from ambient temperature to the temperature set for the air conditioner.

### ▼ Climate Control Display

The climate control system status is displayed. To operate the climate control system, refer to “Climate Control System” (page 6-2).

### ▼ Audio Display

The audio system status is displayed. To operate the audio system, refer to “Audio System” (page 6-15).

## Cup Holder

### ⚠ WARNING

**Never use a cup holder to hold hot liquids while the vehicle is moving:**  
Using a cup holder to hold hot liquids while the vehicle is moving is dangerous. If the contents spill, you could be scalded.

**Do not put anything other than cups or drink cans in cup holders:**

Putting objects other than cups or drink cans in a cup holder is dangerous.  
During sudden braking or maneuvering, occupants could be hit and injured, or objects could be thrown around the vehicle, causing interference with the driver and the possibility of an accident. Only use a cup holder for cups or drink cans.

### ▼ Front

The front cup holder is in the center console.

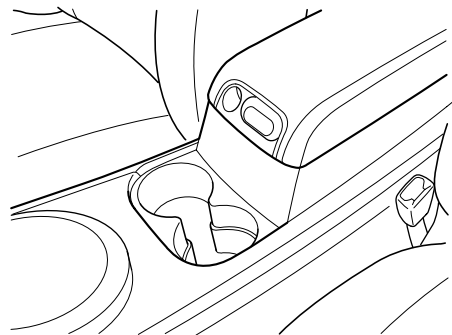

Interior Comfort

## Interior Equipment

### ▼ Rear

The rear cup holder is on the rear center armrest.



### Bottle Holder

Bottle holders are on the inside of the front doors.

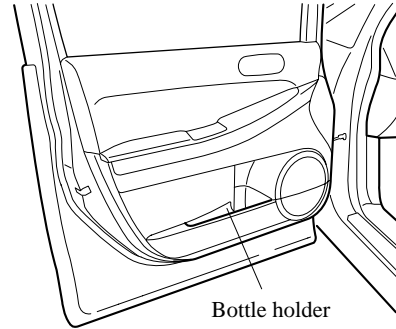

### **⚠ CAUTION**

*Do not use the bottle holders for containers without caps. The contents may spill when the door is opened or closed.*

Interior Comfort  
**Interior Equipment**

### Storage Compartments

#### **⚠ WARNING**

**Keep storage boxes closed when driving:**

*Driving with the storage boxes open is dangerous. To reduce the possibility of injury in an accident or a sudden stop, keep the storage boxes closed when driving.*

#### **⚠ CAUTION**

*Do not leave lighters or eyeglasses in the storage boxes while parked under the sun. A lighter could explode or the plastic material in eyeglasses could deform and crack from high temperature.*

#### ▼ **Glove Box**

To open the glove box, pull the latch toward you.

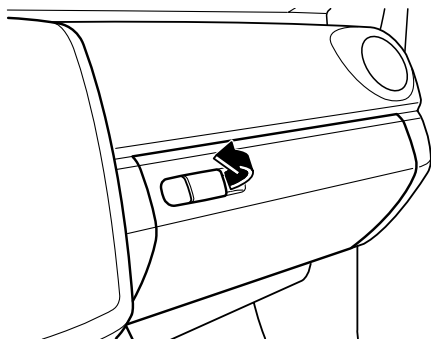

#### ▼ **Center Console**

To open, push the button.

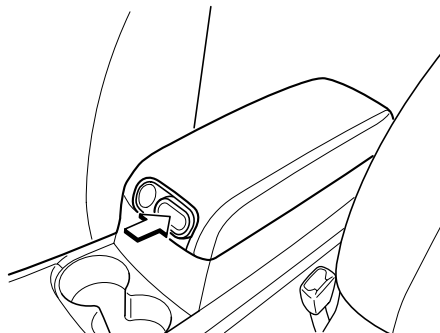

The center console has a lockable lid, insert the key into the slot; then turn the key clockwise to lock, counterclockwise to unlock.

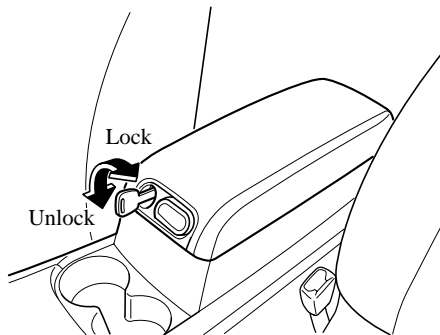

#### ▼ **Cargo Securing Loops**

#### **⚠ WARNING**

**Make sure luggage and cargo is secured before driving:**

*Not securing cargo while driving is dangerous as it could move or be crushed during sudden braking or a collision and cause injury.*

Interior Comfort

## Interior Equipment

Use the loops in the luggage compartment to secure cargo with a rope or net. The tensile strength of the loops is 196 N (20 kgf, 44 lbf). Do not apply excessive force to the loops as it will damage them.

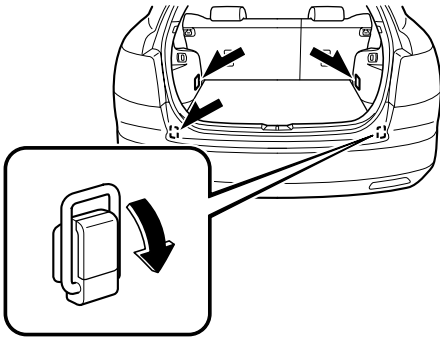

## Accessory Sockets

The ignition switch must be in the ACC or ON position.

Only use genuine Mazda accessories or the equivalent requiring no greater than 120 W (DC 12 V, 10 A).

The accessory socket is in the center console.

### Type A

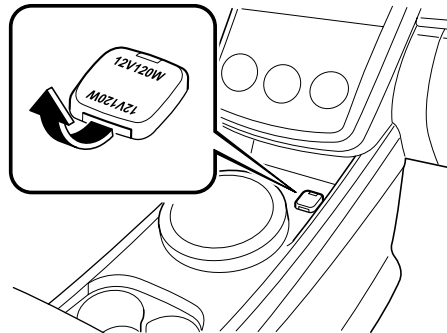

### Type B

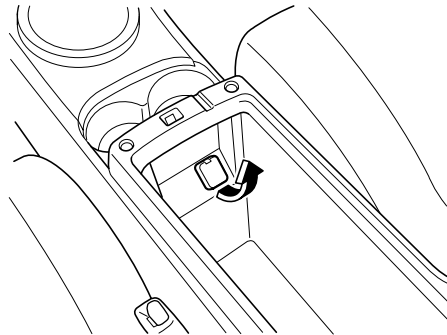

Interior Comfort  
**Interior Equipment**

---

**⚠ CAUTION**

*To prevent accessory socket damage or electrical failure, pay attention to the following:*

- *Do not use accessories that require more than 120 W (DC 12 V, 10 A).*
- *Do not use accessories that are not genuine Mazda accessories or the equivalent.*
- *Close the cover when the accessory socket is not in use to prevent foreign objects and liquids from getting into the accessory socket.*
- *Correctly insert the plug into the accessory socket.*

**NOTE**

*To prevent discharging of the battery, do not use the socket for long periods with the engine off or idling.*

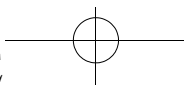
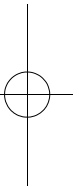
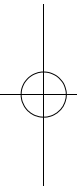
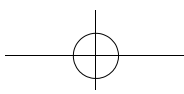

# 7

## In Case of an Emergency

Helpful information on what to do in an emergency.

<b>Parking in an Emergency .....</b>	<b>7-2</b>
Parking in an Emergency .....	7-2
<b>Flat Tire .....</b>	<b>7-3</b>
Spare Tire and Tool Storage .....	7-3
Changing a Flat Tire .....	7-6
<b>Overheating .....</b>	<b>7-11</b>
Overheating .....	7-11
<b>Emergency Starting .....</b>	<b>7-13</b>
Starting a Flooded Engine .....	7-13
Jump-Starting .....	7-14
Push-Starting .....	7-17
<b>Emergency Towing .....</b>	<b>7-18</b>
Towing Description .....	7-18
Tiedown Hooks .....	7-19
Recreational Towing .....	7-21

In Case of an Emergency

## Parking in an Emergency

---

### Parking in an Emergency

The hazard warning lights should always be used when you stop on or near a roadway in an emergency.

The hazard warning lights warn other drivers that your vehicle is a traffic hazard and that they must take extreme caution when near it.

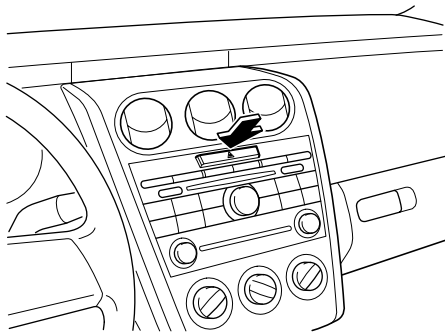

Depress the hazard warning flasher and all the turn signals will flash.

#### **NOTE**

- *The turn signals do not work when the hazard warning lights are on.*
- *Check local regulations about the use of hazard warning lights while the vehicle is being towed to verify that it is not in violation of the law.*



In Case of an Emergency  
**Flat Tire**

**Spare Tire and Tool Storage**

Spare tire and tools are stored in the locations illustrated in the diagram.

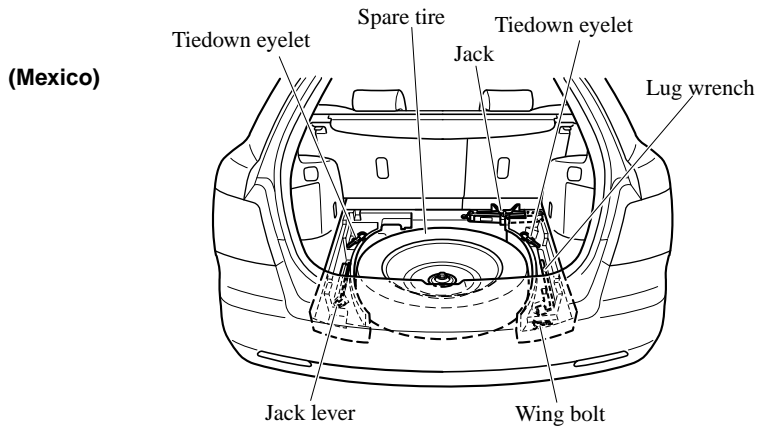
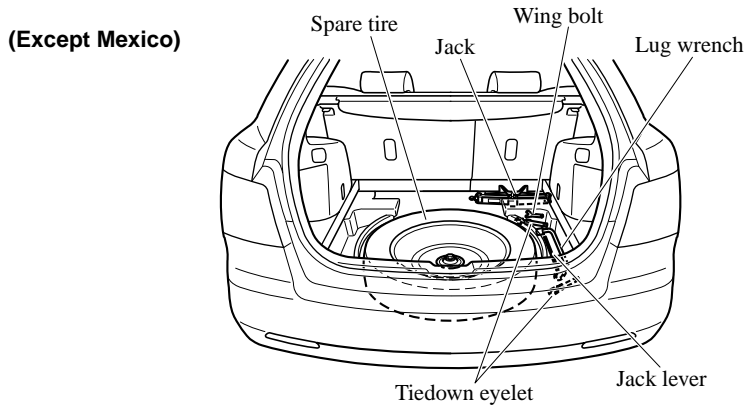

In Case of an Emergency

## Flat Tire

### ▼ Jack

#### To remove the jack

1. Remove the trunk board.

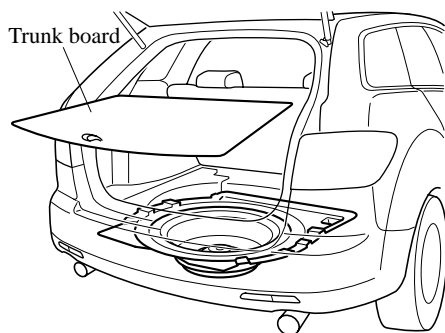

2. Turn the wing bolt and jack screw counterclockwise.

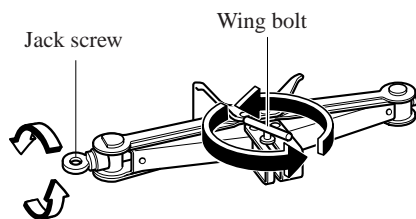

#### **NOTE**

The jack can be removed from the rear door if the rear seatback is folded forward. Refer to Rear Seat on page 2-10.

#### To secure the jack

1. Turn the wing bolt clockwise and temporarily tighten it.
2. Turn the jack screw clockwise and extend the jack to secure it to the vehicle.

3. Turn the wing bolt and tighten it completely.

### ▼ Spare Tire

Your Mazda has a temporary spare tire. The temporary spare tire is lighter and smaller than a conventional tire, and is designed only for emergency use and should be used only for VERY short periods. Temporary spare tires should NEVER be used for long drives or extended periods.

#### **⚠ WARNING**

**Do not install the temporary spare tire on the front wheels (driving wheels) when driving on ice or snow:**

*Driving with a spare tire on the front (driving) wheels on ice or snow is dangerous. Handling will be affected. You could lose control of the vehicle and have an accident. Put the spare tire on the rear axle and move a regular tire to the front.*

In Case of an Emergency

## Flat Tire

### **CAUTION**

- *When using the temporary spare tire, driving stability may decrease compared to when using only the conventional tire. Drive carefully.*
- *To avoid damage to the temporary spare tire or to the vehicle, observe the following precautions:*
  - *Do not exceed 80 km/h (50 mph).*
  - *Avoid driving over obstacles. Also, do not drive through an automatic car wash. This tire's diameter is smaller than a conventional tire's, so the ground clearance is reduced about 25 mm (1 in).*
  - *Do not use a tire chain on this tire because it won't fit properly.*
  - *Do not use your temporary spare tire on any other vehicle; it has been designed only for your Mazda.*
  - *Use only one temporary spare tire on your vehicle at the same time.*
- **(With limited slip differential)**  
*When using the temporary spare tire on the front axle, replace it with a standard tire as soon as possible. The size difference between the spare and the standard tire will cause the limited slip differential to malfunction.*

### **NOTE**

#### **(With Tire Pressure Monitoring System)**

*A tire pressure sensor is not installed to the temporary spare tire. The warning light will flash continuously while the temporary spare tire is being used (page 5-29).*

### **To remove the spare tire**

1. Remove the trunk board, and if a spare tire cover is equipped remove it.

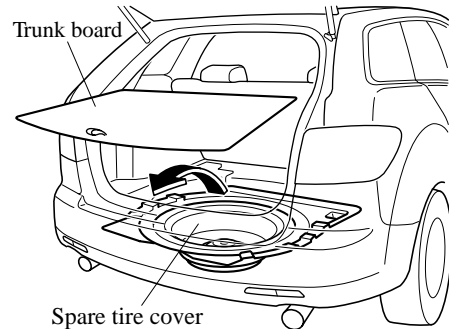

2. Turn the tire hold-down bolt counterclockwise with the lug wrench.

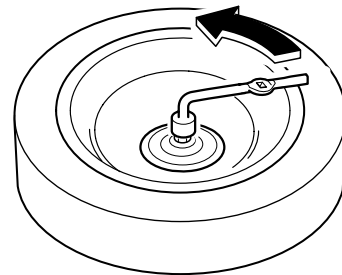

In Case of an Emergency

## Flat Tire

### Changing a Flat Tire

#### NOTE

If the following occurs while driving, it could indicate a flat tire.

- Steering becomes difficult.
- The vehicle begins to vibrate excessively.
- The vehicle pulls in one direction.

If you have a flat tire, drive slowly to a level spot that is well off the road and out of the way of traffic to change the tire. Stopping in traffic or on the shoulder of a busy road is dangerous.

#### **⚠ WARNING**

**Be sure to follow the directions for changing a tire, and never get under a vehicle that is supported only by a jack:**

*Changing a tire is dangerous if not done properly. The vehicle can slip off the jack and seriously injure someone.*

**Never allow anyone inside a vehicle supported by a jack:**

*Allowing someone to remain in a vehicle supported by a jack is dangerous. The occupant could cause the vehicle to fall resulting in serious injury.*

#### **⚠ CAUTION**

**(With Tire Pressure Monitoring System)**

*The wheels equipped on your Mazda are specially designed for installation of the tire pressure sensors. Do not use non-genuine wheels, otherwise it may not be possible to install the tire pressure sensors.*

#### NOTE

- Make sure the jack is well lubricated before using it.

#### **(With Tire Pressure Monitoring System)**

- Be sure to register the tire pressure sensor ID signal code whenever tires or wheels are changed (page 5-31).

1. Park on a level surface off the right-of-way and firmly set the parking brake.
2. Shift into Park (P) and turn off the engine.
3. Turn on the hazard warning flasher.
4. Have everyone get out of the vehicle and away from the vehicle and traffic.
5. Remove the jack, tool, and spare tire (page 7-3).
6. Block the wheel diagonally opposite the flat tire. When blocking a wheel, place a tire block both in front and behind the tire.

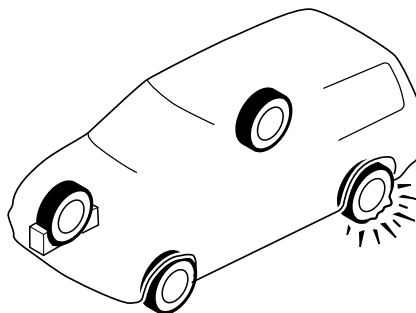

#### NOTE

*When blocking a tire, use rocks or wood blocks of sufficient size if possible to hold the tire in place.*

## Flat Tire

### ▼ Removing a Flat Tire

1. Loosen the lug nuts by turning them counterclockwise one turn each, but don't remove any lug nuts until the tire has been raised off the ground.

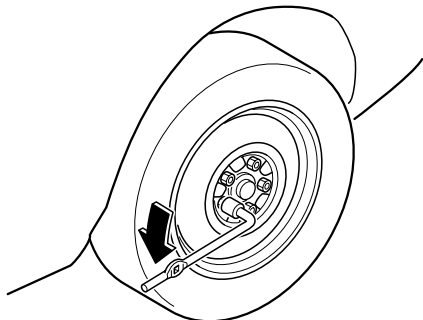

2. Place the jack under the jacking position closest to the tire being changed.

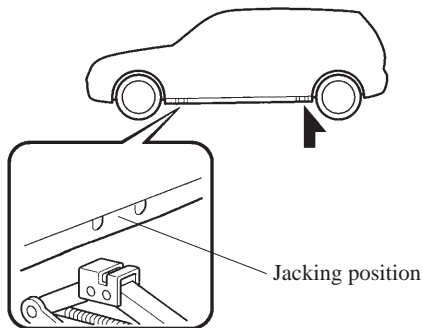

### ⚠ WARNING

**Use only the front and rear jacking positions recommended in this manual:**

*Attempting to jack the vehicle in positions other than those recommended in this manual is dangerous. The vehicle could slip off the jack and seriously injure or even kill someone. Use only the front and rear jacking positions recommended in this manual.*

**Use only the jack provided with your Mazda:**

*Using a jack that is not designed for your Mazda is dangerous. The vehicle could slip off the jack and seriously injure someone.*

**Never place objects under the jack:**

*Jacking the vehicle with an object under the jack is dangerous. The jack could slip and someone could be seriously injured by the jack or the falling vehicle.*

3. Insert the jack lever and attach the lug wrench to tire jack.

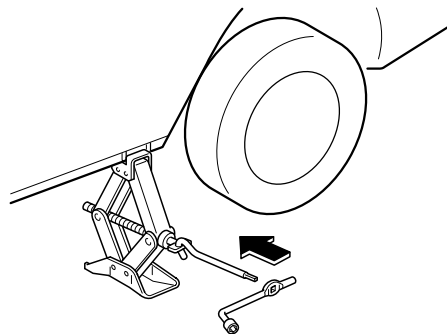

In Case of an Emergency

## Flat Tire

4. Turn the lug wrench clockwise and raise the vehicle high enough so that the spare tire can be installed. Before removing the lug nuts, make sure your Mazda is firmly in position and that it cannot slip or move.

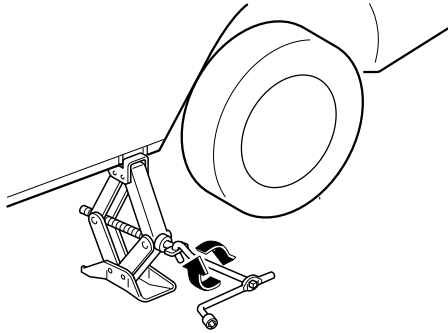

5. Remove the lug nuts by turning them counterclockwise; then remove the wheel and center cap.

### ▼ Locking Lug Nuts\*

If your vehicle has optional antitheft wheel lug nuts, one on each wheel will lock the tires and you must use a special key to unlock them. This key is attached to the lug wrench and is stored with the spare tire. Register them with the lock manufacturer by filling out the card provided in the glove box and mailing it in the accompanying envelope. If you lose this key, consult an Authorized Mazda Dealer or use the lock manufacturer's order form, which is with the registration card.

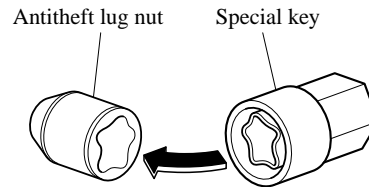

### To remove an antitheft lug nut

1. Obtain the key for the antitheft lug nut.
2. Place the key on top of the nut, and be sure to hold the key square to it. If you hold the key at an angle, you may damage both key and nut. Don't use a power impact wrench.
3. Place the lug wrench on top of the key and apply pressure. Turn the wrench counterclockwise.

## Flat Tire

### **To install the nut**

1. Place the key on top of the nut, and be sure to hold the key square to it. If you hold the key at an angle, you may damage both key and nut. Don't use a power impact wrench.
2. Place the lug wrench on top of the key, apply pressure, and turn it clockwise.

### **▼ Mounting the Spare Tire**

1. Remove dirt and grime from the mounting surfaces of the wheel and hub, including the hub bolts, with a cloth.

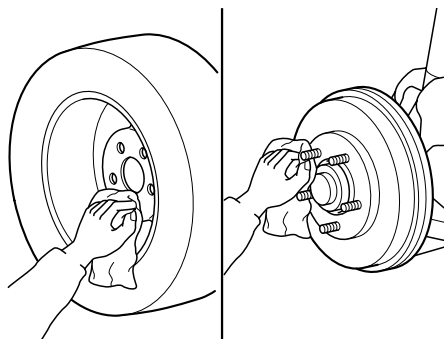

### **! WARNING**

**Make sure the mounting surfaces of the wheel, hub and lug nuts are clean before changing or replacing tires:**

*When changing or replacing a tire, not removing dirt and grime from the mounting surfaces of the wheel, hub and hub bolts is dangerous. The lug nuts could loosen while driving and cause the tire to come off, resulting in an accident.*

2. Mount the spare tire.

3. Install the lug nuts with the beveled edge inward; tighten them by hand.

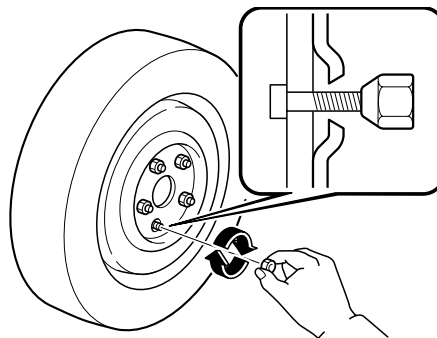

### **! WARNING**

**Do not apply oil or grease to lug nuts and bolts and do not tighten the lug nuts beyond the recommended tightening torque:**

*Applying oil or grease to lug nuts and bolts is dangerous. The lug nuts could loosen while driving and cause the tire to come off, resulting in an accident. In addition, lug nuts and bolts could be damaged if tightened more than necessary.*

4. Turn the jack handle counterclockwise and lower the vehicle. Use the lug wrench to tighten the nuts in the order shown.

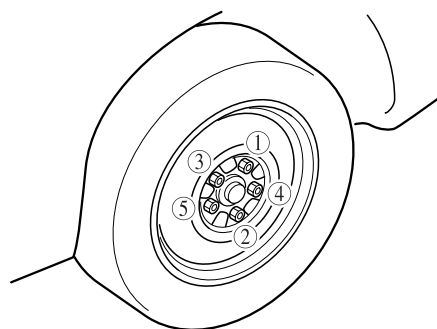

In Case of an Emergency

## Flat Tire

If you're unsure of how tight the nuts should be, have them inspected at an Authorized Mazda Dealer.

Nut tightening torque	
N·m (kgf·m, ft·lbf)	89—117 (9—11, 66—86)

### **⚠ WARNING**

**Always securely and correctly tighten the lug nuts:**

*Improperly or loosely tightened lug nuts are dangerous. The wheel could wobble or come off. This could result in loss of vehicle control and cause a serious accident.*

**Be sure to reinstall the same nuts you removed or replace them with metric nuts of the same configuration:**

*Because the wheel studs and lug nuts on your Mazda have metric threads, using a non-metric nut is dangerous. On a metric stud, it would not secure the wheel and would damage the stud, which could cause the wheel to slip off and cause an accident.*

5. Remove the center cap by tapping it with the jack lever.
6. Store the damaged tire, using the wing bolt to hold it in place.

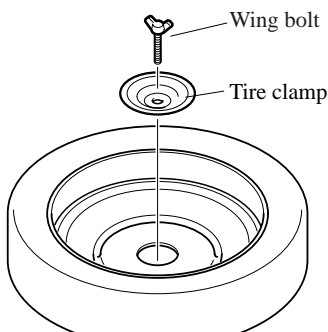

### **NOTE**

*Always use the wing bolt to secure the damaged tire. Store the tire hold-down bolt used to tighten down the spare tire in the same place as where the wing bolt had been stored.*

7. Check the inflation pressure. Refer to the specification charts on page 10-6.
8. Have the flat tire repaired or replaced as soon as possible.

### **⚠ WARNING**

**Do not drive with any tires that have incorrect air pressure:**

*Driving on tires with incorrect air pressure is dangerous. Tires with incorrect pressure could affect handling and result in an accident. When you check the regular tires' air pressure, check the spare tire, too.*

### **NOTE**

**(With Tire Pressure Monitoring System)**  
*A tire pressure sensor is not installed to the temporary spare tire. The warning light will flash continuously while the temporary spare tire is being used (page 5-29).*

### **NOTE**

*To prevent the jack and tool from rattling, store them properly.*



In Case of an Emergency  
**Overheating**

## Overheating

If the temperature gauge indicates overheating, the vehicle loses power, or you hear a loud knocking or pinging noise, the engine is probably too hot.

### **WARNING**



**Turn off the ignition switch and make sure the fan is not running before attempting to work near the cooling fan:**

*Working near the cooling fan when it is running is dangerous. The fan could continue running indefinitely even if the engine has stopped and the engine compartment temperature is high. You could be hit by the fan and seriously injured.*



**Do not remove either cooling system caps when the engine and radiator are hot:**

*When the engine and radiator are hot, scalding coolant and steam may shoot out under pressure and cause serious injury.*

**Open the hood ONLY after steam is no longer escaping from the engine:**

*Steam from an overheated engine is dangerous. The escaping steam could seriously burn you.*

If the temperature gauge indicates overheating:

1. Drive safely to the side of the road and park off the right-of-way.
2. Shift into park (P).

3. Apply the parking brake.
4. Turn off the air conditioner.
5. Check whether coolant or steam is escaping from under the hood or from the engine compartment.

### **If steam is coming from the engine compartment:**

Don't go near the front of the vehicle. Stop the engine.

Wait until the steam dissipates, then open the hood and start the engine.

### **If neither coolant nor steam is escaping:**

Open the hood and idle the engine until it cools.

### **CAUTION**

*If the cooling fan does not operate while the engine is running, the engine temperature will increase. Stop the engine and call an Authorized Mazda Dealer.*

6. Make sure the cooling fan is operating, then turn off the engine after the temperature has decreased.
7. When cool, check the coolant level. If it's low, look for coolant leaks from the radiator and hoses.

In Case of an Emergency

## Overheating

---

**If you find a leak or other damage, or if coolant is still leaking:**

Stop the engine and call an Authorized Mazda Dealer.

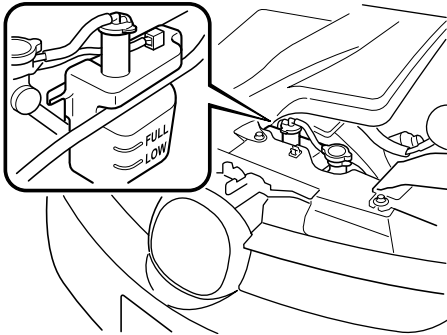

**If you find no problems, the engine is cool, and no leaks are obvious:**

Carefully add coolant as required (page 8-21).

**⚠ CAUTION**

*If the engine continues to overheat or frequently overheats, have the cooling system inspected. The engine could be seriously damaged unless repairs are made. Consult an Authorized Mazda Dealer.*

In Case of an Emergency  
**Emergency Starting**

### Starting a Flooded Engine

If the engine fails to start, it may be flooded (excessive fuel in the engine).

Follow this procedure:

1. If the engine does not start within 5 seconds on the first try, turn the key to the LOCK position, wait 10 seconds and try again.
2. Depress the accelerator all the way and hold it there.
3. Turn the ignition switch to the START position and hold it there—for up to 10 seconds. If the engine starts, release the key and accelerator immediately because the engine will suddenly rev up.
4. If the engine fails to start, crank it without depressing the accelerator—for up to 10 seconds.

If the engine still does not start using the above procedure, have your vehicle inspected by an Authorized Mazda Dealer.

In Case of an Emergency

## Emergency Starting

### Jump-Starting

Jump-starting is dangerous if done incorrectly. So follow the procedure carefully. If you feel unsure about jump-starting, we strongly recommend that you have a competent service technician do the work.

#### **WARNING**



##### **Follow These Precautions Carefully:**

*To ensure safe and correct handling of the battery, read the following precautions carefully before using the battery or inspecting it.*



##### **Always wear eye protection when working near the battery:**

*Working without eye protection is dangerous. Battery fluid contains SULFURIC ACID which could cause blindness if splashed into your eyes. Also, hydrogen gas produced during normal battery operation, could ignite and cause the battery to explode.*



##### **Wear eye protection and protective gloves to prevent contact with battery fluid:**

*Spilled battery fluid is dangerous. Battery fluid contains SULFURIC ACID which could cause serious injuries if it gets in eyes, skin or clothing. If this happens, immediately flush your eyes with water for 15 minutes or wash your skin thoroughly and get medical attention.*



##### **Always keep batteries out of the reach of children:**

*Allowing children to play near batteries is dangerous. Battery fluid could cause serious injuries if it gets in the eyes or on the skin.*



##### **Do not allow the positive (+) terminal to contact any other metal object that could cause sparks:**

*Flames and sparks near open battery cells are dangerous. Hydrogen gas, produced during normal battery operation, could ignite and cause the battery to explode. An exploding battery can cause serious burns and injuries. When working near a battery, do not allow metal tools to contact the positive (+) or negative (-) terminal of the battery.*

In Case of an Emergency  
**Emergency Starting**



**Keep all flames, including cigarettes, and sparks away from open battery cells:**  
Flames and sparks near open battery cells are dangerous. Hydrogen gas, produced during normal battery operation, could ignite and cause the battery to explode. An exploding battery can cause serious burns and injuries.

**Do not jump-start a frozen battery or one with a low fluid level:**

Jump-starting a frozen battery or one with a low fluid level is dangerous. It may rupture or explode, causing serious injury.

**Connect the negative cable to a good ground point away from the battery:**

Connecting the end of the second jumper cable to the negative (–) terminal of the discharged battery is dangerous.

A spark could cause the gas around the battery to explode and injure someone.

**Route the jumper cables away from parts that will be moving:**

Connecting a jumper cable near or to moving parts (cooling fans, belts) is dangerous. The cable could get caught when the engine starts and cause serious injury.

**CAUTION**

Use only a 12 V booster system. You can damage a 12 V starter, ignition system, and other electrical parts beyond repair with a 24 V power supply (two 12 V batteries in series or a 24 V motor generator set).

Connect cables in numerical order and disconnect in reverse order

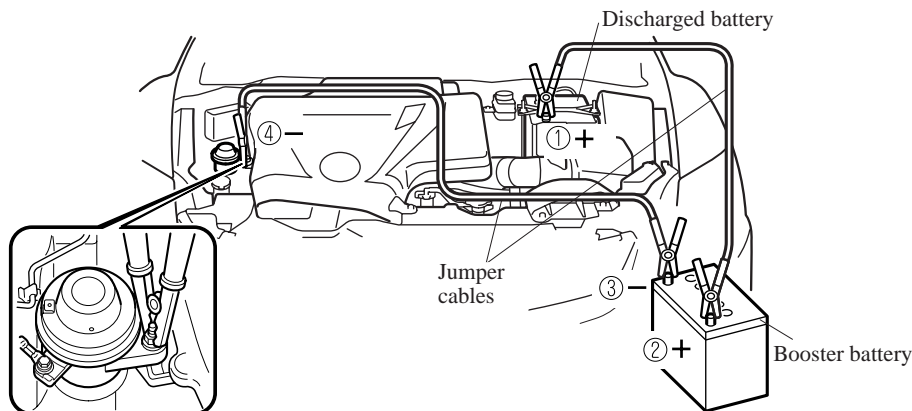

In Case of an Emergency

## Emergency Starting

1. Remove the battery cover.

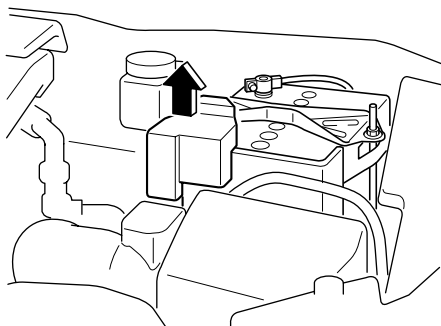

2. Make sure the booster battery is 12 V and that its negative terminal is grounded.
3. If the booster battery is in another vehicle, don't allow both vehicles to touch. Turn off the engine of the vehicle with the booster battery and all unnecessary electrical loads in both vehicles.
4. Connect the jumper cables in the exact sequence as in the illustration.
  - Connect one end of a cable to the positive terminal on the discharged battery (1).
  - Attach the other end to the positive terminal on the booster battery (2).
  - Connect one end of the other cable to the negative terminal of the booster battery (3).
  - Connect the other end to the ground point indicated in the illustration away from the discharged battery (4).
5. Start the engine of the booster vehicle and run it a few minutes. Then start the engine of the other vehicle.

6. When finished, carefully disconnect the cables in the reverse order described in the illustration.
7. If the battery cover has been removed, install it in the reverse order of removal.

### **NOTE**

*Verify that the covers are securely installed.*

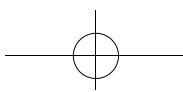

In Case of an Emergency  
**Emergency Starting**

---

**Push-Starting**

Do not push-start your Mazda.

**NOTE**

*You can't start a vehicle with an automatic transaxle by pushing it.*

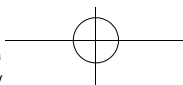

In Case of an Emergency

## Emergency Towing

### Towing Description

We recommend that towing be done only by an Authorized Mazda Dealer or a commercial tow-truck service.

Proper lifting and towing are necessary to prevent damage to the vehicle. Particularly when towing a AWD vehicle, where all the wheels are connected to the drive train, proper transporting of the vehicle is absolutely essential to avoid damaging the drive system. Government and local laws must be followed.

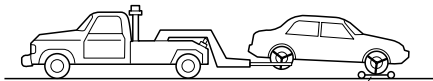

Wheel dollies

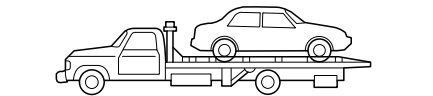

A towed 2WD vehicle should have its drive wheels (front wheels) off the ground. If excessive damage or other conditions prevent this, use wheel dollies.

When towing a 2WD vehicle with the rear wheels on the ground, release the parking brake.

A towed AWD vehicle must have all its wheels off the ground.

### CAUTION

*Don't tow the vehicle pointed backward with driving wheels on the ground. This may cause internal damage to the transaxle.*

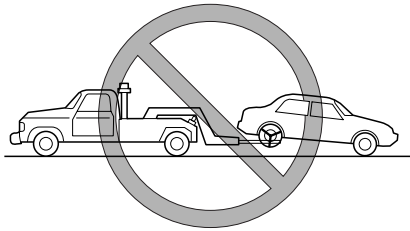

### CAUTION

*Don't tow with sling-type equipment. This could damage your vehicle. Use wheel-lift or flatbed equipment.*

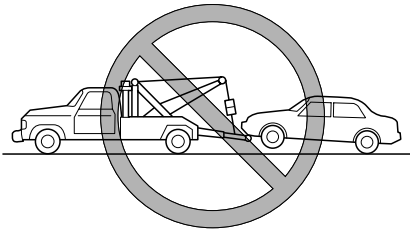



In Case of an Emergency  
**Emergency Towing**

**⚠ WARNING**

**Always tow a AWD vehicle with all four wheels off the ground:**

*Towing a AWD vehicle with either the front or rear wheels on the ground is dangerous as the drive train could be damaged, or the vehicle could trail away from the tow truck and cause an accident. If the drive train has been damaged, transport the vehicle on a flat bed truck.*

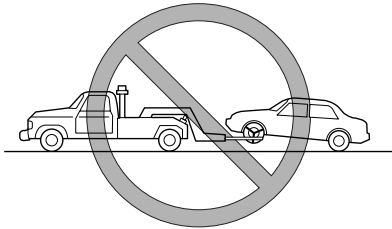

**Tiedown Hooks**

**⚠ CAUTION**

*Don't use the tiedown hooks under the front and rear for towing. They are designed ONLY for tying down the vehicle when it's being transported. Using them for towing will damage the bumper.*

▼ **Tiedown Hooks**

1. Remove the tiedown eyelet, lug wrench, and jack lever from the trunk (page 7-3).
2. Wrap the jack lever with a soft cloth to prevent damage to the bumper and open the cap located on the front and rear bumper.

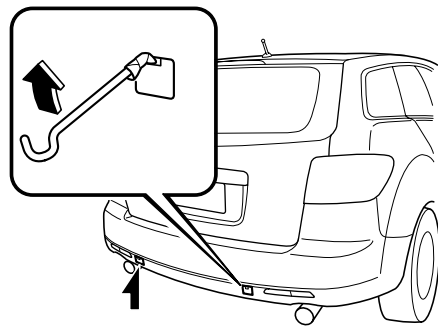
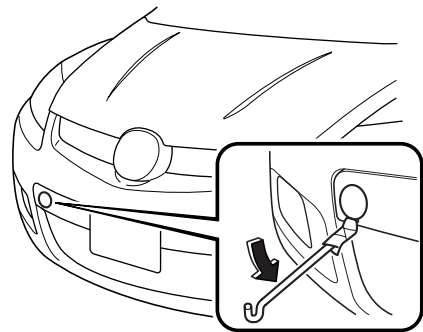

In Case of an Emergency

## Emergency Towing

### **⚠ CAUTION**

*The cap cannot be completely removed. Do not use excessive force as it may damage the cap or scratch the painted bumper surface.*

3. Securely install the tiedown eyelet using the lug wrench.



4. Hook the tying rope to the tiedown eyelet.

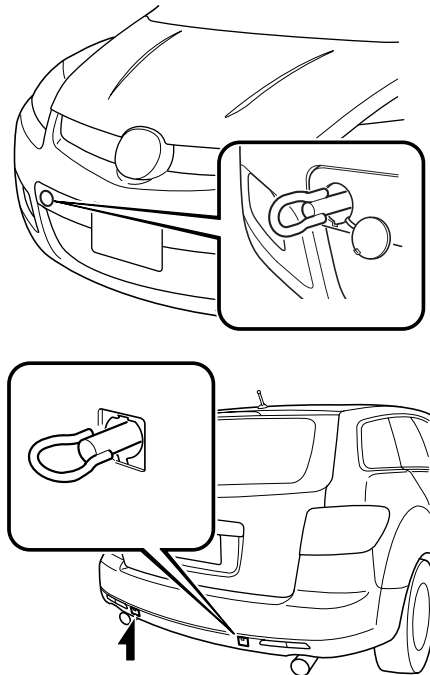

### **⚠ CAUTION**

*If the tiedown eyelet is not securely tightened, it may loosen or disengage from the bumper when tying down the vehicle. Make sure that the tiedown eyelet is securely tightened to the bumper.*

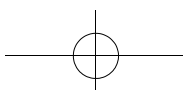

In Case of an Emergency  
**Emergency Towing**

---

### Recreational Towing

An example of “recreational towing” is towing your vehicle behind a motorhome. The transaxle is not designed for towing this vehicle on all 4 wheels.

When doing recreational towing refer to “Towing Description” (page 7-18) and “Tiedown Hooks” (page 7-19) and carefully follow the instructions.

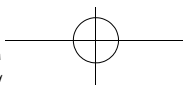

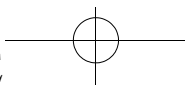
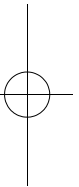
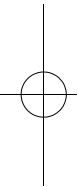
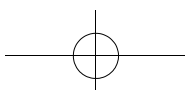

# 8 Maintenance and Care

How to keep your Mazda in top condition.

<b>Introduction .....</b>	<b>8-2</b>
Introduction .....	8-2
<b>Scheduled Maintenance .....</b>	<b>8-3</b>
Scheduled Maintenance (USA, Canada, and Puerto Rico) .....	8-3
Scheduled Maintenance (Mexico) .....	8-9
<b>Owner Maintenance .....</b>	<b>8-16</b>
Owner Maintenance Schedule .....	8-16
Owner Maintenance Precautions .....	8-17
Engine Compartment Overview .....	8-18
Engine Oil .....	8-19
Engine Coolant .....	8-21
Brake Fluid .....	8-23
Power Steering Fluid .....	8-24
Automatic Transaxle Fluid (ATF) .....	8-25
Washer Fluid .....	8-27
Body Lubrication .....	8-28
Wiper Blades .....	8-28
Battery .....	8-32
Tires .....	8-34
Light Bulbs .....	8-39
Fuses .....	8-45
<b>Appearance Care .....</b>	<b>8-50</b>
How to Minimize Environmental Paint Damage .....	8-50
Exterior Care .....	8-52
Interior Care .....	8-55

Maintenance and Care

## Introduction

---

### Introduction

Be extremely careful and prevent injury to yourself and others or damage to your vehicle when using this manual for inspection and maintenance.

If you're unsure about any procedure it describes, we strongly urge you to have a reliable and qualified service shop perform the work, preferably an Authorized Mazda Dealer.

Factory-trained Mazda technicians and genuine Mazda parts are best for your vehicle. Without this expertise and the parts that have been designed and made especially for your Mazda, inadequate, incomplete, and insufficient servicing may result in problems. This could lead to vehicle damage or an accident and injuries.

For expert advice and quality service, consult an Authorized Mazda Dealer.

The owner should retain evidence that proper maintenance has been performed as prescribed.

Claims against the warranty resulting from lack of maintenance, as opposed to defective materials or authorized Mazda workmanship, will not be honored.

Any auto repair shop using parts equivalent to your Mazda's original equipment may perform maintenance. **But we recommend that it always be done by an Authorized Mazda Dealer using genuine Mazda parts.**

Maintenance and Care  
**Scheduled Maintenance**

---

**Scheduled Maintenance (USA, Canada, and Puerto Rico)**

Follow Schedule 1 if the vehicle is operated mainly where none of the following conditions apply.

- Repeated short-distance driving
- Driving in dusty conditions
- Driving with extended use of brakes
- Driving in areas where salt or other corrosive materials are being used
- Driving on rough or muddy roads
- Extended periods of idling or low-speed operation
- Driving for long periods in cold temperatures or extremely humid climates
- Driving in extremely hot conditions
- Driving in mountainous conditions continually

If any do apply, follow Schedule 2 (Canada and Puerto Rico residents follow Schedule 2).

**NOTE**

*After the prescribed period, continue to follow the described maintenance at the recommended intervals.*

Maintenance and Care

# Scheduled Maintenance

## ▼ Schedule 1

Maintenance Interval	Number of months or kilometers (miles), whichever comes first								
	Months	6	12	18	24	30	36	42	48
	×1000 km	12	24	36	48	60	72	84	96
	×1000 miles	7.5	15	22.5	30	37.5	45	52.5	60
<b>ENGINE</b>									
Engine valve clearance	Audible inspect every 120,000 km (75,000 miles), if noisy, adjust								
Drive belts (tension)						I			
Engine oil	R	R	R	R	R	R	R	R	R
Engine oil filter	R	R	R	R	R	R	R	R	R
<b>COOLING SYSTEM</b>									
Engine coolant	FL22 type *1	Replace at first 192,000 km (120,000 miles) or 10 years ;after that, every 96,000 km (60,000 miles) or 5 years							
	Others	Replace at first 96,000 km (60,000 miles) or 4 years; after that, every 2 years							
<b>FUEL SYSTEM</b>									
Air filter						R			
Fuel lines and hoses *2					I				I
Hoses and tubes for emission *2									I
<b>IGNITION SYSTEM</b>									
Spark plugs	Replace every 120,000 km (75,000 miles)								
<b>CHASSIS and BODY</b>									
Brake lines, hoses and connections					I				I
Disc brakes		I			I		I		I
Tire (Rotation)	Rotate every 12,000 km (7,500 miles)								
Steering operation and linkages					I				I
Front and rear suspension, ball joints and wheel bearing axial play					I				I
Rear differential oil (AWD)	*3*4								
Transfer oil (AWD)	*4								
Driveshaft dust boots					I				I
Bolts and nuts on chassis and body					T				T
Exhaust system and heat shields	Inspect every 72,000 km (45,000 miles) or 5 years								
All locks and hinges	L	L	L	L	L	L	L	L	L



Maintenance and Care  
**Scheduled Maintenance**

Maintenance Interval	Number of months or kilometers (miles), whichever comes first								
	Months	6	12	18	24	30	36	42	48
	×1000 km	12	24	36	48	60	72	84	96
	×1000 miles	7.5	15	22.5	30	37.5	45	52.5	60
<b>AIR CONDITIONER SYSTEM</b>									
Cabin air filter					Replace every 40,000 km (25,000 miles) or 2 years				

**Chart symbols:**

**I:** Inspect: Inspect and clean, repair, adjust, or replace if necessary.

**R:** Replace

**L:** Lubricate

**T:** Tighten

**Remarks:**

- \*1 Use FL22 type coolant in vehicles with the inscription "FL22" on the radiator cap itself or the surrounding area. Use FL22 when replacing the coolant.
- \*2 According to state/provincial and federal regulations, failure to perform maintenance on these items will not void your emissions warranties. However, Mazda recommends that all maintenance services be performed at the recommended time or mileage/kilometer period to ensure long-term reliability.
- \*3 If the vehicle is operated primarily under any of the following conditions, replace the rear differential oil at every 45,000 km (28,100 miles).
  - a) Towing a trailer or using a car-top carrier
  - b) Driving in dusty, sandy or wet condition
  - c) Extended periods of idling or low speed operation
  - d) Repeated short trips of less than 16 km (10 miles)
- \*4 If this component has been submerged in water, the oil should be replaced.

Maintenance and Care

# Scheduled Maintenance

## ▼ Schedule 2

Maintenance Interval	Number of months or kilometers (miles), whichever comes first												
	Months	4	8	12	16	20	24	28	32	36	40	44	48
	×1000 km	8	16	24	32	40	48	56	64	72	80	88	96
	×1000 miles	5	10	15	20	25	30	35	40	45	50	55	60
<b>ENGINE</b>													
Engine valve clearance	Audible inspect every 120,000 km (75,000 miles), if noisy, adjust												
Drive belts (tension)								I					
Engine oil	Puerto Rico	Replace every 5,000 km (3,000 miles) or 3 months											
	Others	R	R	R	R	R	R	R	R	R	R	R	R
Engine oil filter		R	R	R	R	R	R	R	R	R	R	R	R
<b>COOLING SYSTEM</b>													
Engine coolant	FL22 type*1	Replace at first 192,000 km (120,000 miles) or 10 years ;after that, every 96,000 km (60,000 miles) or 5 years											
	Others	Replace at first 96,000 km (60,000 miles) or 4 years; after that, every 2 years											
Engine coolant level		I	I	I	I	I	I	I	I	I	I	I	I
<b>FUEL SYSTEM</b>													
Air filter	Puerto Rico						R						R
	Others							R					
Fuel lines and hoses*2							I						I
Hoses and tubes for emission*2													I
<b>IGNITION SYSTEM</b>													
Spark plugs	USA	Replace every 96,000 km (60,000 miles)											
	Others*3	Replace every 120,000 km (75,000 miles)											
<b>ELECTRICAL SYSTEM</b>													
Function of all lights		I	I	I	I	I	I	I	I	I	I	I	I

Maintenance and Care  
**Scheduled Maintenance**

Maintenance Interval	Number of months or kilometers (miles), whichever comes first												
	Months	4	8	12	16	20	24	28	32	36	40	44	48
	×1000 km	8	16	24	32	40	48	56	64	72	80	88	96
	×1000 miles	5	10	15	20	25	30	35	40	45	50	55	60
<b>CHASSIS and BODY</b>													
Brake lines, hoses and connections							I						I
Brake fluid level	I	I	I	I	I	I	I	I	I	I	I	I	I
Disc brakes			I				I			I			I
Tire (Rotation)	Rotate every 8,000 km (5,000 miles)												
Tire inflation pressure and tire wear	I	I	I	I	I	I	I	I	I	I	I	I	I
Steering operation and linkages							I						I
Power steering fluid level	I	I	I	I	I	I	I	I	I	I	I	I	I
Front and rear suspension, ball joints and wheel bearing axial play							I						I
Rear differential oil (AWD)	*4*5												
Transfer oil (AWD)	*5												
Driveshaft dust boots							I						I
Bolts and nuts on chassis and body							T						T
Exhaust system and heat shields	Inspect every 72,000 km (45,000 miles) or 5 years												
All locks and hinges	L	L	L	L	L	L	L	L	L	L	L	L	L
Washer fluid level	I	I	I	I	I	I	I	I	I	I	I	I	I

Maintenance and Care

## Scheduled Maintenance

Maintenance Interval	Number of months or kilometers (miles), whichever comes first												
	Months	4	8	12	16	20	24	28	32	36	40	44	48
	×1000 km	8	16	24	32	40	48	56	64	72	80	88	96
	×1000 miles	5	10	15	20	25	30	35	40	45	50	55	60
<b>AIR CONDITIONER SYSTEM</b>													
Cabin air filter		Replace every 40,000 km (25,000 miles) or 2 years											

**Chart symbols:**

**I:** Inspect: Inspect and clean, repair, adjust, or replace if necessary.

**R:** Replace

**L:** Lubricate

**T:** Tighten

**Remarks:**

- \*1 Use FL22 type coolant in vehicles with the inscription "FL22" on the radiator cap itself or the surrounding area. Use FL22 when replacing the coolant.
- \*2 According to state/provincial and federal regulations, failure to perform maintenance on these items will not void your emissions warranties. However, Mazda recommends that all maintenance services be performed at the recommended time or mileage/kilometer period to ensure long-term reliability.
- \*3 If the vehicle is operated primarily under any of the following conditions, replace the spark plugs at every 96,000 km (60,000 miles) or shorter.
  - a) Repeated short-distance driving
  - b) Extended periods of idling or low-speed operation
  - c) Driving for long periods in cold temperatures or extremely humid climates
- \*4 If the vehicle is operated primarily under any of the following conditions, replace the rear differential oil at every 45,000 km (28,100 miles).
  - a) Towing a trailer or using a car-top carrier
  - b) Driving in dusty, sandy or wet condition
  - c) Extended periods of idling or low speed operation
  - d) Repeated short trips of less than 16 km (10 miles)
- \*5 If this component has been submerged in water, the oil should be replaced.

Maintenance and Care  
**Scheduled Maintenance**

---

**Scheduled Maintenance (Mexico)**

Follow Schedule 1 if the vehicle is operated mainly where none of the following conditions apply.

- Repeated short-distance driving
- Driving in dusty conditions
- Driving with extended use of brakes
- Driving in areas where salt or other corrosive materials are being used
- Driving on rough or muddy roads
- Extended periods of idling or low-speed operation
- Driving for long periods in cold temperatures or extremely humid climates
- Driving in extremely hot conditions
- Driving in mountainous conditions continually

If any do apply, follow Schedule 2.

**NOTE**

*After the prescribed period, continue to follow the described maintenance at the recommended intervals.*

Maintenance and Care

# Scheduled Maintenance

## ▼ Schedule 1

Maintenance Interval	Number of months or kilometers, whichever comes first												
	Months	6	12	18	24	30	36	42	48	54	60	66	72
	×1000 km	10	20	30	40	50	60	70	80	90	100	110	120
<b>ENGINE</b>													
Engine valve clearance	Audible inspect every 120,000 km, if noisy, adjust												
Drive belts				I				I					I
Engine oil	R	R	R	R	R	R	R	R	R	R	R	R	R
Engine oil filter	R	R	R	R	R	R	R	R	R	R	R	R	R
<b>COOLING SYSTEM</b>													
Cooling system				I				I					I
Engine coolant	FL22 type*1	Replace at first 190,000 km or 10 years; after that, every 60,000 km or 3 years											
	Others				R				R				R
<b>FUEL SYSTEM</b>													
Air filter		R		R		R		R		R		R	
Fuel lines and hoses				I*2				I*2					I
Hoses and tubes for emission				I*2				I*2					I
Fuel filter				R				R					R
<b>IGNITION SYSTEM</b>													
Spark plugs	Replace every 60,000 km												
<b>CHASSIS and BODY</b>													
Brake lines, hoses and connections		I		I		I		I		I		I	
Brake fluid level	I	I	I			I	I	I		I	I	I	
Brake fluid				R				R					R
Disc brakes	I	I	I	I	I	I	I	I	I	I	I	I	I
Tire (Rotation)	Rotate every 10,000 km												
Tire inflation pressure and tire wear	I	I	I	I	I	I	I	I	I	I	I	I	I
Steering operation and linkages	I	I	I	I	I	I	I	I	I	I	I	I	I
Power steering fluid level	I	I	I	I	I	I	I	I	I	I	I	I	I
Front and rear suspension, ball joints and wheel bearing axial play		I		I		I		I		I		I	
Rear differential oil (AWD)	*3*4												
Transfer oil (AWD)	*4												
Driveshaft dust boots		I		I		I		I		I		I	
Bolts and nuts on chassis and body		T		T		T		T		T		T	
Exhaust system and heat shields		I		I		I		I		I		I	
All locks and hinges	L	L	L	L	L	L	L	L	L	L	L	L	L
Washer fluid level	I	I	I	I	I	I	I	I	I	I	I	I	I

## Scheduled Maintenance

Maintenance Interval	Number of months or kilometers, whichever comes first													
	Months	6	12	18	24	30	36	42	48	54	60	66	72	
	×1000 km	10	20	30	40	50	60	70	80	90	100	110	120	
<b>AIR CONDITIONER SYSTEM</b>														
Cabin air filter						R				R				R

**Chart symbols:**

**I:** Inspect: Inspect and clean, repair, adjust, or replace if necessary.

**R:** Replace

**L:** Lubricate

**T:** Tighten

**Remarks:**

- \*1 Use FL22 type coolant in vehicles with the inscription "FL22" on the radiator cap itself or the surrounding area. Use FL22 when replacing the coolant.
- \*2 According to state/provincial and federal regulations, failure to perform maintenance on these items will not void your emissions warranties. However, Mazda recommends that all maintenance services be performed at the recommended time or kilometer period to ensure long-term reliability.
- \*3 If the vehicle is operated primarily under any of the following conditions, replace the rear differential oil at every 40,000 km.
  - a) Towing a trailer or using a car-top carrier
  - b) Driving in dusty, sandy or wet condition
  - c) Extended periods of idling or low speed operation
  - d) Repeated short trips of less than 16 km
- \*4 If this component has been submerged in water, the oil should be replaced.

Maintenance and Care

# Scheduled Maintenance

## ▼ Schedule 2

Maintenance Interval	Number of months or kilometers, whichever comes first												
	Months	3	6	9	12	15	18	21	24	27	30	33	36
	×1000 km	5	10	15	20	25	30	35	40	45	50	55	60
<b>ENGINE</b>													
Engine valve clearance	Audible inspect every 120,000 km, if noisy, adjust												
Drive belts									I				
Engine oil	R	R	R	R	R	R	R	R	R	R	R	R	R
Engine oil filter	R	R	R	R	R	R	R	R	R	R	R	R	R
<b>COOLING SYSTEM</b>													
Cooling system									I				
Engine coolant	FL22 type*1	Replace at first 190,000 km or 10 years; after that, every 60,000 km or 3 years											
	Others								R				
Engine coolant level	I	I	I	I	I	I	I	I	I	I	I	I	I
<b>FUEL SYSTEM</b>													
Air filter		C		R		C		R		C		R	
Fuel lines and hoses								I*2					
Hoses and tubes for emission								I*2					
Fuel filter								R					
<b>IGNITION SYSTEM</b>													
Spark plugs	Replace every 60,000 km												
<b>ELECTRICAL SYSTEM</b>													
Function of all lights	I	I	I	I	I	I	I	I	I	I	I	I	I



Maintenance and Care  
**Scheduled Maintenance**

Maintenance Interval	Number of months or kilometers, whichever comes first												
	Months	3	6	9	12	15	18	21	24	27	30	33	36
	×1000 km	5	10	15	20	25	30	35	40	45	50	55	60
<b>CHASSIS and BODY</b>													
Brake lines, hoses and connections					I					I			I
Brake fluid level		I			I			I				I	I
Brake fluid									R				
Disc brakes		I			I			I				I	I
Tire (Rotation)	Rotate every 10,000 km												
Tire inflation pressure and tire wear		I			I			I			I		I
Steering operation and linkages		I			I			I			I		I
Power steering fluid level		I			I			I			I		I
Front and rear suspension, ball joints and wheel bearing axial play					I					I			I
Rear differential oil (AWD)	*3 *4												
Transfer oil (AWD)	*4												
Driveshaft dust boots					I					I			I
Bolts and nuts on chassis and body					T					T			T
Exhaust system and heat shields					I					I			I
All locks and hinges		L			L			L			L		L
Washer fluid level		I			I			I			I		I
<b>AIR CONDITIONER SYSTEM</b>													
Cabin air filter					R					R			R

**Chart symbols:**

- I:** Inspect: Inspect and clean, repair, adjust, or replace if necessary.
- R:** Replace
- L:** Lubricate
- C:** Clean
- T:** Tighten

**Remarks:**

- \*1 Use FL22 type coolant in vehicles with the inscription “FL22” on the radiator cap itself or the surrounding area. Use FL22 when replacing the coolant.
- \*2 According to state/provincial and federal regulations, failure to perform maintenance on these items will not void your emissions warranties. However, Mazda recommends that all maintenance services be performed at the recommended time or kilometer period to ensure long-term reliability.
- \*3 If the vehicle is operated primarily under any of the following conditions, replace the rear differential oil at every 40,000 km.
  - a) Towing a trailer or using a car-top carrier
  - b) Driving in dusty, sandy or wet condition
  - c) Extended periods of idling or low speed operation
  - d) Repeated short trips of less than 16 km
- \*4 If this component has been submerged in water, the oil should be replaced.

Maintenance and Care

# Scheduled Maintenance

(Cont.)

Maintenance Interval	Number of months or kilometers, whichever comes first												
	Months	39	42	45	48	51	54	57	60	63	66	69	72
	×1000 km	65	70	75	80	85	90	95	100	105	110	115	120
<b>ENGINE</b>													
Engine valve clearance	Audible inspect every 120,000 km, if noisy, adjust												
Drive belts				I									I
Engine oil	R	R	R	R	R	R	R	R	R	R	R	R	R
Engine oil filter	R	R	R	R	R	R	R	R	R	R	R	R	R
<b>COOLING SYSTEM</b>													
Cooling system				I									I
Engine coolant	FL22 type*1	Replace at first 190,000 km or 10 years; after that, every 60,000 km or 3 years											
	Others				R								R
Engine coolant level	I	I	I	I	I	I	I	I	I	I	I	I	I
<b>FUEL SYSTEM</b>													
Air filter		C		R		C		R		C			R
Fuel lines and hoses				I*2									I
Hoses and tubes for emission				I*2									I
Fuel filter				R									R
<b>IGNITION SYSTEM</b>													
Spark plugs	Replace every 60,000 km												
<b>ELECTRICAL SYSTEM</b>													
Function of all lights	I	I	I	I	I	I	I	I	I	I	I	I	I

Maintenance and Care  
**Scheduled Maintenance**

Maintenance Interval	Number of months or kilometers, whichever comes first												
	Months	39	42	45	48	51	54	57	60	63	66	69	72
	×1000 km	65	70	75	80	85	90	95	100	105	110	115	120
<b>CHASSIS and BODY</b>													
Brake lines, hoses and connections					I				I				I
Brake fluid level		I					I		I		I		
Brake fluid					R								R
Disc brakes		I			I		I		I		I		I
Tire (Rotation)	Rotate every 10,000 km												
Tire inflation pressure and tire wear		I			I		I		I		I		I
Steering operation and linkages		I			I		I		I		I		I
Power steering fluid level		I			I		I		I		I		I
Front and rear suspension, ball joints and wheel bearing axial play					I				I				I
Rear differential oil (AWD)	*3 *4												
Transfer oil (AWD)	*4												
Driveshaft dust boots					I				I				I
Bolts and nuts on chassis and body					T				T				T
Exhaust system and heat shields					I				I				I
All locks and hinges		L			L		L		L		L		L
Washer fluid level		I			I		I		I		I		I
<b>AIR CONDITIONER SYSTEM</b>													
Cabin air filter					R				R				R

**Chart symbols:**

- I:** Inspect: Inspect and clean, repair, adjust, or replace if necessary.
- R:** Replace
- L:** Lubricate
- C:** Clean
- T:** Tighten

**Remarks:**

- \*1 Use FL22 type coolant in vehicles with the inscription “FL22” on the radiator cap itself or the surrounding area. Use FL22 when replacing the coolant.
- \*2 According to state/provincial and federal regulations, failure to perform maintenance on these items will not void your emissions warranties. However, Mazda recommends that all maintenance services be performed at the recommended time or kilometer period to ensure long-term reliability.
- \*3 If the vehicle is operated primarily under any of the following conditions, replace the rear differential oil at every 40,000 km.
  - a) Towing a trailer or using a car-top carrier
  - b) Driving in dusty, sandy or wet condition
  - c) Extended periods of idling or low speed operation
  - d) Repeated short trips of less than 16 km
- \*4 If this component has been submerged in water, the oil should be replaced.

Maintenance and Care

## Owner Maintenance

---

### Owner Maintenance Schedule

The owner or a qualified service technician should make these vehicle inspections at the indicated intervals to ensure safe and dependable operation.

Bring any problem to the attention of an Authorized Mazda Dealer or qualified service technician as soon as possible.

#### ▼ When Refueling

- Brake fluid level (page 8-23)
- Engine coolant level (page 8-21)
- Engine oil level (page 8-20)
- Washer fluid level (page 8-27)

#### ▼ At Least Monthly

Tire inflation pressures (page 8-34)

#### ▼ At Least Twice a Year (For Example, Every Spring and Fall)

- Automatic transaxle fluid level (page 8-25)
- Power steering fluid level (page 8-24)

You can do the following scheduled maintenance items if you have some mechanical ability and a few basic tools and if you closely follow the directions in this manual.

- Engine coolant (page 8-21)
- Engine oil (page 8-19)

Maintenance and Care  
**Owner Maintenance**

## Owner Maintenance Precautions

Improper or incomplete service may result in problems. This section gives instructions only for items that are easy to perform.

As explained in the Introduction (page 8-2), several procedures can be done only by a qualified service technician with special tools.

Improper owner maintenance during the warranty period may affect warranty coverage. For details, read the separate Mazda Warranty statement provided with the vehicle. If you're unsure about any servicing or maintenance procedure, have it done by an Authorized Mazda Dealer.

There are strict environmental laws regarding the disposal of waste oil and fluids. Please dispose of your waste properly and with due regard to the environment.

We recommend that you entrust the oil and fluid changes of your vehicle to an Authorized Mazda Dealer.

### **⚠ WARNING**

***Do not perform maintenance work if you lack sufficient knowledge and experience or the proper tools and equipment to do the work. Have maintenance work done by a qualified technician:***

*Performing maintenance work on a vehicle is dangerous if not done properly. You can be seriously injured while performing some maintenance procedures.*

***If you must run the engine while working under the hood, make certain that you remove all jewelry (especially rings, bracelets, watches, and necklaces) and all neckties, scarves, and similar loose clothing before getting near the engine or cooling fan which may turn on unexpectedly:***

*Working under the hood with the engine running is dangerous. It becomes even more dangerous when you wear jewelry or loose clothing.*

*Either can become entangled in moving parts and result in injury.*

***Turn off the ignition switch and make sure the fan is not running before attempting to work near the cooling fan:***

*Working near the cooling fan when it is running is dangerous. The fan could continue running indefinitely even if the engine has stopped and the engine compartment temperature is high. You could be hit by the fan and seriously injured.*

Maintenance and Care

# Owner Maintenance

## Engine Compartment Overview

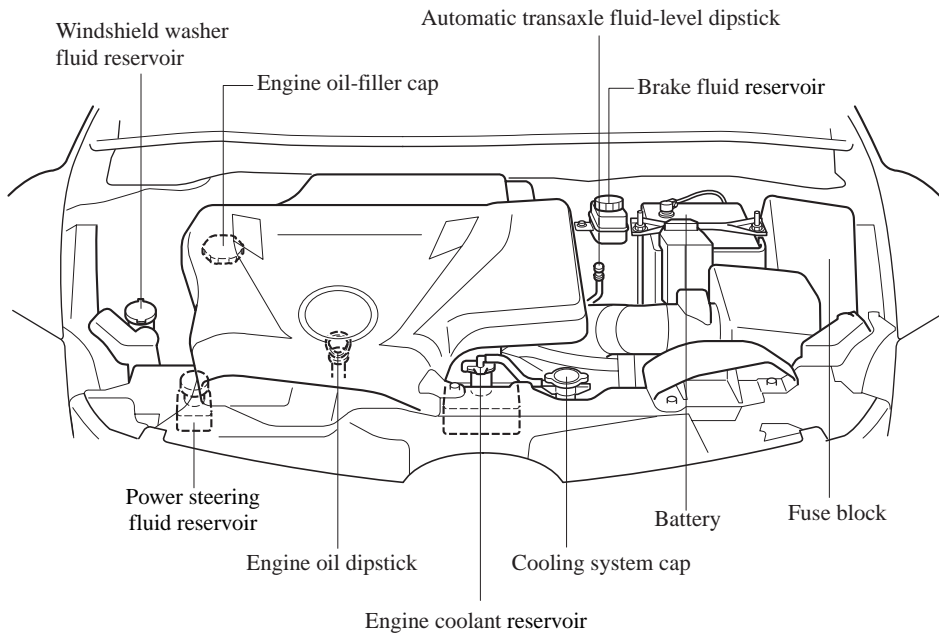

Maintenance and Care  
**Owner Maintenance**

## Engine Oil

**NOTE**

*Changing the engine oil should be done by an Authorized Mazda Dealer.*

**▼ Recommended Oil**

**Use SAE 5W-30 engine oil.**

Oil container labels provide important information.

A chief contribution this type of oil makes to fuel economy is reducing the amount of fuel necessary to overcome engine friction.

**U.S.A. and CANADA**



(ILSAC)

Only use oils “Certified For Gasoline Engines” by the American Petroleum Institute (API). An oil with this trademark symbol conforms to the current engine and emission system protection standards and fuel economy requirements of the International Lubricant Standardization and Approval Committee (ILSAC), comprised of U.S. and Japanese automobile manufacturers.

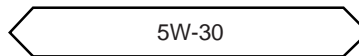
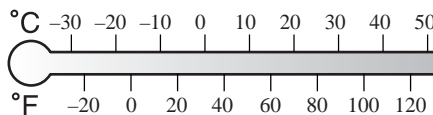

**Except U.S.A. and CANADA**



(ILSAC)

Maintenance and Care

## Owner Maintenance

The quality designation SM, or ILSAC must be on the label.

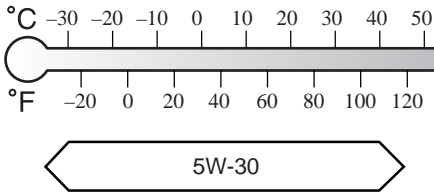

### ▼ Inspecting Engine Oil Level

1. Be sure the vehicle is on a level surface.
2. Warm up the engine to normal operating temperature.
3. Turn it off and wait at least 5 minutes for the oil to return to the oil pan.
4. Open the cap.

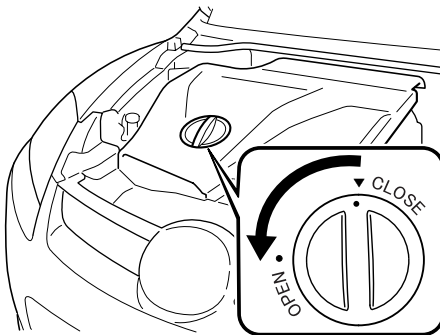

5. Pull out the dipstick, wipe it clean, and reinsert it fully.

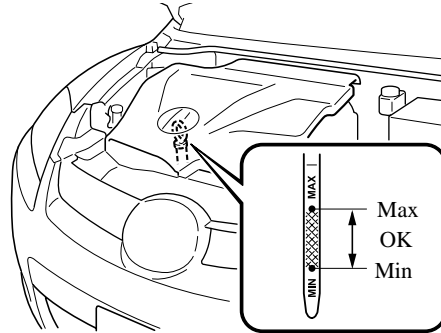

6. Pull it out again and examine the level. It's OK between MIN and MAX. But if it's near or below MIN, add enough oil to bring the level to MAX.

### ⚠ CAUTION

*Don't add engine oil over MAX. This may cause engine damage.*

7. Make sure the O-ring on the dipstick is positioned properly before reinserting the dipstick.
8. Close the cap.

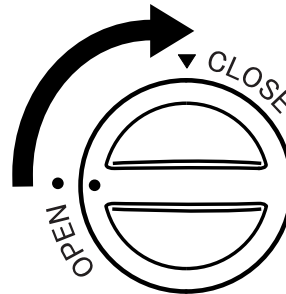



Maintenance and Care  
**Owner Maintenance**

**NOTE**

When closing the engine oil cap, place the cap with the (●) mark aligned at the OPEN (●) position and then turn the cap to the CLOSE (▼) position.

## Engine Coolant

### ▼ Inspecting Coolant Level

#### **WARNING**

**Do not use a match or live flame in the engine compartment. DO NOT ADD COOLANT WHEN THE ENGINE IS HOT:**

A hot engine is dangerous. If the engine has been running, parts of the engine compartment can become very hot. You could be burned.

Carefully inspect the engine coolant in the coolant reservoir, but do not open it.



 **Turn off the ignition switch and make sure the fan is not running before attempting to work near the cooling fan:**

Working near the cooling fan when it is running is dangerous. The fan could continue running indefinitely even if the engine has stopped and the engine compartment temperature is high. You could be hit by the fan and seriously injured.



**Do not remove either cooling system cap when the engine and radiator are hot:**

When the engine and radiator are hot, scalding coolant and steam may shoot out under pressure and cause serious injury.

**NOTE**

Changing the coolant should be done by an Authorized Mazda Dealer.

Maintenance and Care

## Owner Maintenance

Inspect the antifreeze protection and coolant level in the coolant reservoir at least once a year—at the beginning of the winter season—and before traveling where temperatures may drop below freezing.

Inspect the condition and connections of all cooling system and heater hoses. Replace any that are swollen or deteriorated.

The coolant should be at full in the radiator and between the FULL and LOW marks on the coolant reservoir when the engine is cool.

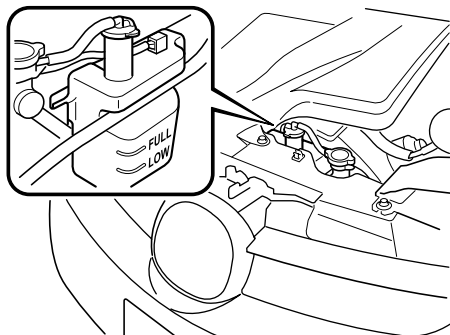

If it's at or near LOW, add enough coolant to the coolant reservoir to provide freezing and corrosion protection and to bring the level to FULL.

### **CAUTION**

- *Radiator coolant will damage paint. Rinse it off quickly if spilled.*
- *Use only soft (demineralized) water in the coolant mixture. Water that contains minerals will cut down on the coolant's effectiveness.*
- *Don't add only water. Always add a proper coolant mixture.*
- *The engine has aluminum parts and must be protected by an ethylene-glycol-based coolant to prevent corrosion and freezing.*
- *DO NOT USE coolants Containing Alcohol, methanol, Borate or Silicate. These coolants could damage the cooling system.*
- *DO NOT MIX alcohol or methanol with the coolant. This could damage the cooling system.*
- *Don't use a solution that contains more than 60% antifreeze. This would reduce effectiveness.*

Maintenance and Care  
**Owner Maintenance**

**NOTE**

*If the "FL22" mark is shown on or near the cooling system cap, use FL22 type engine coolant. If engine coolant other than FL22 type is used, the engine coolant must be replaced earlier than the specified replacement interval indicated in the scheduled maintenance (page 8-3).*



If the coolant reservoir is empty or new coolant is required frequently, consult an Authorized Mazda Dealer.

## Brake Fluid

### ▼ Inspecting Brake Fluid Level

Inspect the fluid level in the reservoir regularly. It should be kept at MAX. The level normally drops with accumulated distance, a condition associated with wear of brake linings. If it is excessively low, have the brake system inspected by an Authorized Mazda Dealer.

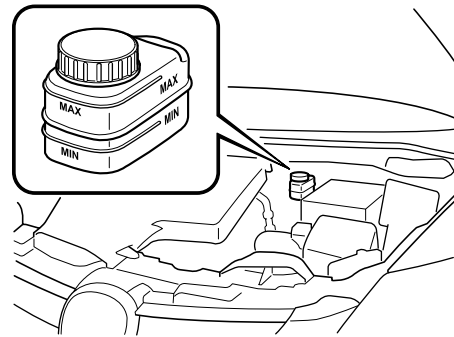

Maintenance and Care

## Owner Maintenance

### ▼ Adding Brake Fluid

#### **⚠ WARNING**

**Be careful not to spill brake fluid on yourself or on the engine:**

*Spilled brake fluid is dangerous. If it gets in your eyes, they could be seriously injured. If this happens, immediately flush your eyes with water and get medical attention. Brake fluid spilled on a hot engine could cause a fire.*

**If the brake/clutch fluid level is low, have the brakes and clutch inspected:**

*Low brake fluid levels are dangerous. Low levels could signal brake lining wear or a brake system leak. Your brakes could fail and cause an accident.*

If the fluid level is low, add fluid until it reaches MAX.

Before adding fluid, thoroughly clean the area around the cap.

#### **⚠ CAUTION**

- *Brake fluid will damage painted surfaces. If brake fluid does get on a painted surface, wash it off with water immediately.*
- *Using nonspecified brake fluids (page 10-4) will damage the system. Mixing different fluids will also damage it. If the brake system frequently requires new fluid, consult an Authorized Mazda Dealer.*

### Power Steering Fluid

#### ▼ Inspecting Power Steering Fluid Level

#### **⚠ CAUTION**

*To avoid damage to the power steering pump, don't operate the vehicle for long periods when the power steering fluid level is low.*

#### **NOTE**

*Use specified power steering fluid (page 10-4).*

Inspect the fluid level at each engine oil change. Add fluid if necessary; it does not require periodic changing.

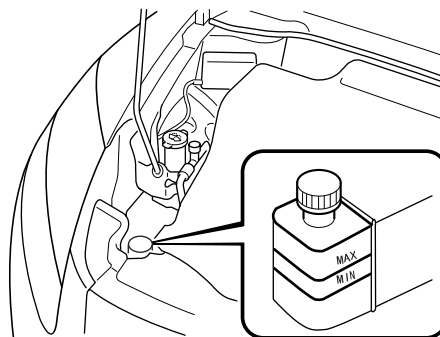

The level must be kept between the MAX and MIN marks.

Visually examine the lines and hoses for leaks and damage.

1. Park on a level surface, well off the right-of-way, and set the parking brake firmly.
2. Turn off the engine and allow it to cool.
3. Remove the filler cap and attached dipstick.
4. Wipe them clean and put them back.

Maintenance and Care  
**Owner Maintenance**

5. Remove again and inspect the level.
6. It must be between MAX and MIN.  
Add fluid if necessary.

**Don't overfill.**

If new fluid is required frequently, consult an Authorized Mazda Dealer.

## Automatic Transaxle Fluid (ATF)

### ▼ Inspecting Automatic Transaxle Fluid Level

The automatic transaxle fluid level should be inspected regularly. Measure it as described below.

The volume of fluid changes with temperature. Fluid must be checked while idling the engine without driving at normal operating temperature.

#### CAUTION

- *Low fluid level causes transaxle slippage. Overfilling can cause foaming, loss of fluid, and transaxle malfunction.*
- *Use specified fluid (page 10-4). A nonspecified fluid could result in transaxle malfunction and failure.*

1. Park on a level surface and set the parking brake firmly.
2. Start the engine and depress the brake pedal.
3. Move the shift lever through all ranges, then set it at P.

#### WARNING

***Make sure the brake pedal is applied before shifting the shift lever:***

*Shifting the shift lever without first depressing the brake pedal is dangerous. The vehicle could move suddenly and cause an accident.*

4. With the engine still idling, pull out the dipstick, wipe it clean, and put it back.

Maintenance and Care

## Owner Maintenance

5. Pull it out again.

The proper fluid level is marked on the dipstick as follows.

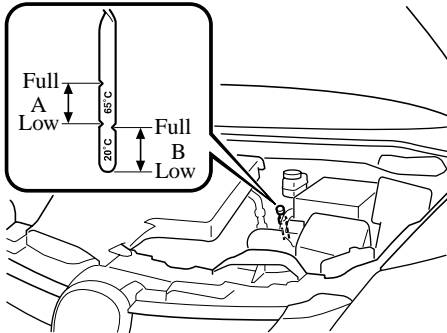

### **Fluid hot scale A**

When the vehicle has been driven and the fluid is at normal operating temperature, about 65°C (150°F), the level must be between Full and Low.

### **Fluid cold scale B**

When the engine has not been running and the outside temperature is about 20°C (70°F), the fluid level should be close to, but not above, the bottom notch on the dipstick.

### **CAUTION**

- Use the cold scale only as a reference.
- If outside temperature is lower than about 20°C (70°F), start the engine and inspect the fluid level after the engine reaches operating temperature.
- If the vehicle has been driven for an extended period at high speeds or in city traffic in hot weather, inspect the level only after stopping the engine and allowing the fluid to cool for 30 minutes.

Fully insert the dipstick. When adding fluid, inspect with the dipstick to make sure it doesn't pass full.

### **NOTE**

*Inspect the fluid on both sides of the dipstick in a well lit area for an accurate reading.*

Maintenance and Care  
**Owner Maintenance**

## Washer Fluid

### ▼ Inspecting Washer Fluid Level

#### **⚠ WARNING**

**Use only windshield washer fluid or plain water in the reservoir:**

*Using radiator antifreeze as washer fluid is dangerous. If sprayed on the windshield, it will dirty the windshield, affect your visibility, and could result in an accident.*

#### **Using Washer Fluid Without Anti-freeze Protection in Cold Weather:**

*Operating your vehicle in temperatures below 4 degrees C (40 degrees F) using washer fluid without anti-freeze protection is dangerous as it could cause impaired windshield vision and result in an accident. In cold weather, always use washer fluid with anti-freeze protection.*

#### **NOTE**

*State or local regulations may restrict the use of volatile organic compounds (VOCs), which are commonly used as anti-freeze agents in washer fluid. A washer fluid with limited VOC content should be used only if it provides adequate freeze resistance for all regions and climates in which the vehicle will be operated.*

Inspect fluid level in the washer fluid reservoir; add fluid if necessary.

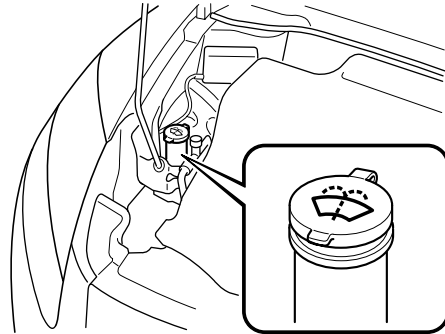

Use plain water if washer fluid is unavailable. But use only washer fluid in cold weather to prevent it from freezing.

#### **NOTE**

*Front and rear washer fluid is supplied from the same reservoir.*

Maintenance and Care

## Owner Maintenance

### Body Lubrication

All moving points of the body, such as door and hood hinges and locks, should be lubricated each time the engine oil is changed. Use a nonfreezing lubricant on locks during cold weather.

Make sure the hood's secondary latch keeps the hood from opening when the primary latch is released.

### Wiper Blades

#### **CAUTION**

- *Hot waxes applied by automatic car washers have been known to affect the wiper's ability to clean windows.*
- *To prevent damage to the wiper blades, don't use gasoline, kerosene, paint thinner, or other solvents on or near them.*

Contamination of either the windshield or the blades with foreign matter can reduce wiper effectiveness. Common sources are insects, tree sap, and hot wax treatments used by some commercial car washes.

If the blades are not wiping properly, clean the window and blades with a good cleaner or mild detergent; then rinse thoroughly with clean water. Repeat if necessary.

#### **▼ Replacing Windshield Wiper Blades**

When the wipers no longer clean well, the blades are probably worn or cracked. Replace them.

#### **CAUTION**

*To prevent damage to the wiper arms and other components, don't try to sweep the wiper arm by hand.*

#### **NOTE**

*To prevent damage to the wiper arm blades when raising both the driver and passenger side wiper arms, raise the driver side wiper arm first. Conversely, when setting down the wiper arms, set the passenger side wiper arm down first.*

1. Raise the wiper arm.



Maintenance and Care  
**Owner Maintenance**

2. Open the clip and slide the blade assembly in the direction of the arrow.

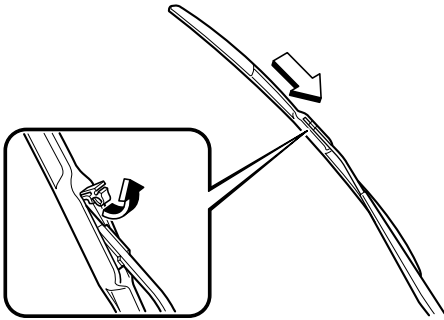

3. Tilt the blade assembly and remove it from the arm.

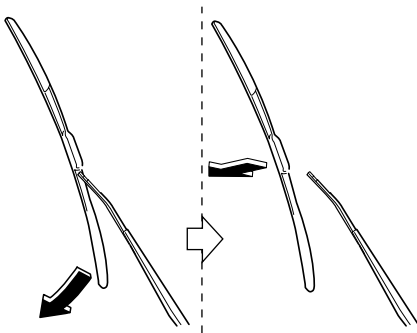

**CAUTION**

*To prevent damage to the windshield let the wiper arm down easily, don't let it slap down on the windshield.*

4. Pull down the blade rubber and slide it out of blade holder.

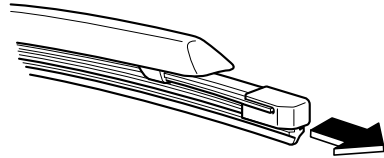

5. Remove the metal stiffeners from each blade rubber and install them in the new blade.

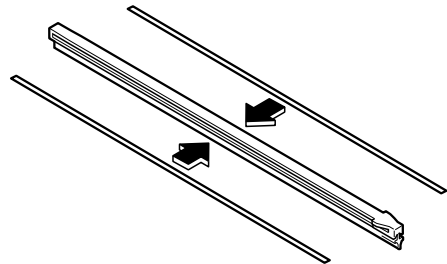

Maintenance and Care

## Owner Maintenance

### **CAUTION**

- *Don't bend or discard the stiffeners. You need to use them again.*
- *If the metal stiffeners are switched, the blade's wiping efficiency could be reduced. So don't use the driver's side metal stiffeners on the passenger's side, or vice versa.*
- *Be sure to reinstall the metal stiffeners in the new blade rubber so that the curve is the same as it was in the old blade rubber.*

6. Carefully insert the new blade rubber. Then install the blade assembly in the reverse order of removal.

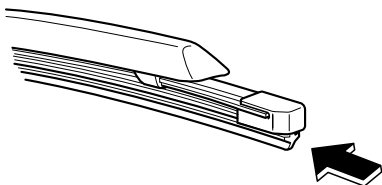

### ▼ Replacing Rear Window Wiper Blade

When the wiper no longer cleans well, the blade is probably worn or cracked. Replace it.

### **CAUTION**

*To prevent damage to the wiper arm and other components, don't try to sweep the wiper arm by hand.*

1. Remove the cover and raise the wiper arm.

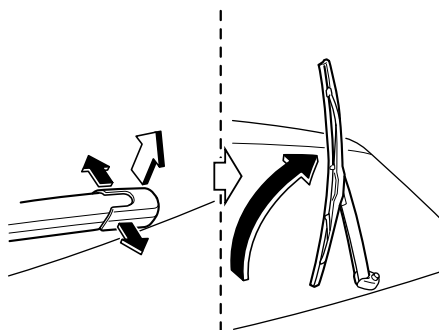

2. Firmly rotate the wiper blade to the right until it unlocks, then remove the blade.

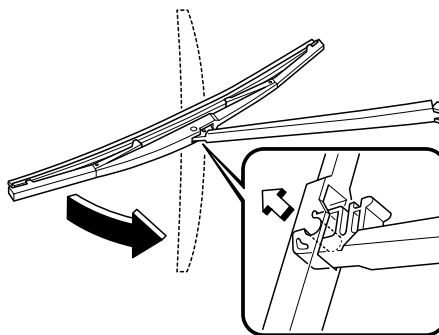

### **CAUTION**

*To prevent damage to the rear window let the wiper arm down easily, don't let it slap down on the rear window.*

Maintenance and Care  
**Owner Maintenance**

3. Pull down the blade rubber and slide it out of the blade holder.

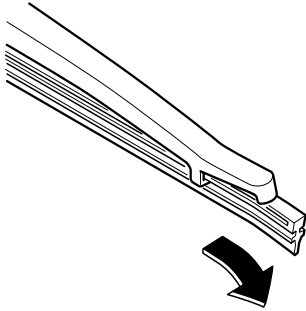

4. Remove the metal stiffeners from each blade rubber and install them in the new blade.

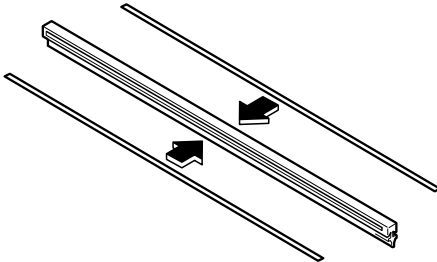

**CAUTION**

*Don't bend or discard the stiffeners.  
You need to use them again.*

5. Carefully insert the new blade rubber. Then install the blade assembly in the reverse order of removal.

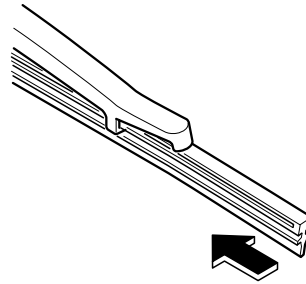

Maintenance and Care

## Owner Maintenance

### Battery

#### **WARNING**

**Wash hands after handling the battery and related accessories:**

*Battery posts, terminals and related accessories contain lead and lead compounds, chemicals known to the State of California to cause cancer and reproductive harm.*



**Read the following precautions carefully before using the battery or inspecting to ensure safe and correct handling:**



**Always wear eye protection when working near the battery:**

*Working without eye protection is dangerous. Battery fluid contains SULFURIC ACID which could cause blindness if splashed into your eyes. Also, hydrogen gas produced during normal battery operation, could ignite and cause the battery to explode.*



**Wear eye protection and protective gloves to prevent contact with battery fluid:**

*Spilled battery fluid is dangerous. Battery fluid contains SULFURIC ACID which could cause serious injuries if it gets in eyes, or on the skin or clothing. If this happens, immediately flush your eyes with water for 15 minutes or wash your skin thoroughly and get medical attention.*



**Always keep batteries out of the reach of children:**

*Allowing children to play near batteries is dangerous. Battery fluid could cause serious injuries if it gets in the eyes or on the skin.*



**Keep flames and sparks away from open battery cells and do not allow metal tools to contact the positive (+) or negative (-) terminal of the battery when working near a battery. Do not allow the positive (+) terminal to contact the vehicle body:**

*Flames and sparks near open battery cells are dangerous. Hydrogen gas, produced during normal battery operation, could ignite and cause the battery to explode. An exploding battery can cause serious burns and injuries. Keep all flames including cigarettes and sparks away from open battery cells.*

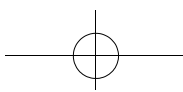

Maintenance and Care

## Owner Maintenance

---



**Keep all flames, including cigarettes, and sparks away from open battery cells:**  
*Flames and sparks near open battery cells are dangerous. Hydrogen gas, produced during normal battery operation, could ignite and cause the battery to explode. An exploding battery can cause serious burns and injuries.*

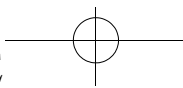
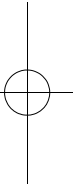
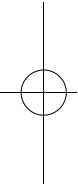

Maintenance and Care

## Owner Maintenance

### NOTE

Remove the battery cover before performing battery maintenance.

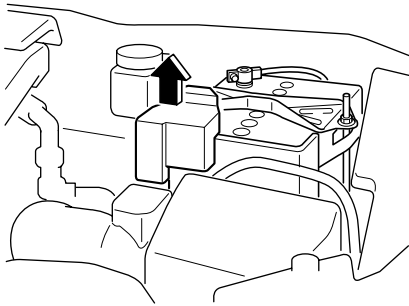

### ▼ Battery Maintenance

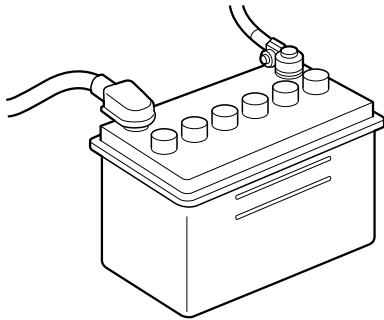

To get the best service from a battery:

- Keep it securely mounted.
- Keep the top clean and dry.
- Keep terminals and connections clean, tight, and coated with petroleum jelly or terminal grease.
- Rinse off spilled electrolyte immediately with a solution of water and baking soda.
- If the vehicle will not be used for an extended time, disconnect the battery cables.

## Tires

For reasons of proper performance, safety, and better fuel economy, always maintain recommended tire inflation pressures and stay within the recommended load limits and weight distribution.

### ⚠ WARNING

#### Using Different Tire Types:

Driving your vehicle with different types of tires is dangerous. It could cause poor handling and poor braking; leading to loss of control. Except for the limited use of the temporary spare tire, use only the same type tires (radial, bias-belted, bias-type) on all four wheels.

#### Using Wrong-Sized Tires:

Using any other tire size than what is specified for your Mazda (page 10-6) is dangerous. It could seriously affect ride, handling, ground clearance, tire clearance, and speedometer calibration. This could cause you to have an accident. Use only tires that are the correct size specified for your Mazda.

### ▼ Tire Inflation Pressure

### ⚠ WARNING

Always inflate the tires to the correct pressure:

Overinflation or underinflation of tires is dangerous. Adverse handling or unexpected tire failure could result in a serious accident. Refer to specification charts on page 10-6.

Maintenance and Care  
**Owner Maintenance**

The Tire Pressure Monitoring System\* does not alleviate the need to check the tire condition every day, including whether the tires all look inflated properly. Inspect all tire pressure monthly (including the spare) when the tires are cold. Maintain recommended pressures for the best ride, handling, and minimum tire wear.

When checking the tire pressures, use of a digital tire pressure gauge is recommended.

**Except Canada (Tire pressure label)**

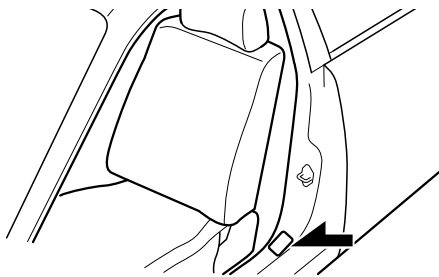

**Canada (Motor vehicle safety standard label)**

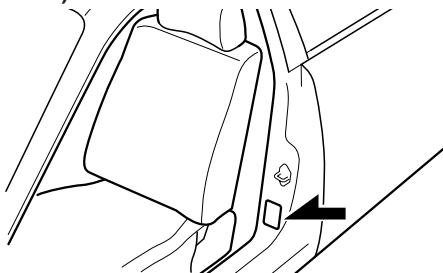

Refer to the specification charts (page 10-6).

**NOTE**

- Always check tire pressure when tires are cold.
- Warm tires normally exceed recommended pressures. Don't release air from warm tires to adjust the pressure.
- Underinflation can cause reduced fuel economy, uneven and accelerated tire wear, and poor sealing of the tire bead, which will deform the wheel and cause separation of tire from rim.
- Overinflation can produce a harsh ride, uneven and accelerated tire wear, and a greater possibility of damage from road hazards.

Keep your tire pressure at the correct levels. If one frequently needs inflating, have it inspected.

**▼ Tire Rotation**

To equalize tread wear, rotate the tires if irregular wear develops. According to the scheduled maintenance charts. Refer to Scheduled Maintenance on page 8-3. During rotation, inspect them for correct balance.

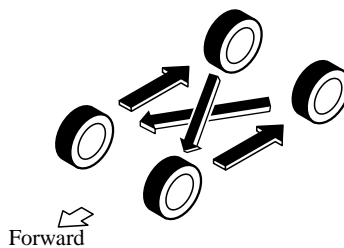

Do not include (TEMPORARY USE ONLY) spare tire in rotation.

Also, inspect them for uneven wear and damage. Abnormal wear is usually caused by one or a combination of the following:

- Incorrect tire pressure

Maintenance and Care

## Owner Maintenance

- Improper wheel alignment
- Out-of-balance wheel
- Severe braking

After rotation, inflate all tire pressures to specification (page 10-6) and inspect the lug nuts for tightness.

### CAUTION

Rotate unidirectional tires and radial tires that have an asymmetrical tread pattern or studs only from front to rear, not from side to side. Tire performance will be weakened if rotated from side to side.

### CAUTION

Limited-Slip Differential system; don't use the following:

- Tires not of the designated size
- Tires of different sizes or types at the same time
- Tires not sufficiently inflated

If these instructions aren't followed, the rotation of the left and right wheels will be different and will thus apply a constant load on the limited-slip differential.  
This will cause a malfunction.

### ▼ Replacing a Tire

### WARNING

Always use tires that are in good condition:

Driving with worn tires is dangerous. Reduced braking, steering, and traction could result in an accident.

### CAUTION

#### (With Tire Pressure Monitoring System)

When replacing/repairing the tires or wheels or both, have the work done by an Authorized Mazda Dealer, or the tire pressure sensors may be damaged.

#### NOTE

##### (With Tire Pressure Monitoring System)

- When tires with steel wire reinforcement in the sidewalls are used, the system may not function correctly even with a genuine wheel.  
Refer to System Error Activation on page 5-31.
- Be sure to install the tire pressure sensors whenever tires or wheels are replaced.  
Refer to Tires and Wheels on page 5-31.

If a tire wears evenly, a wear indicator will appear as a solid band across the tread.

Replace the tire when this happens.

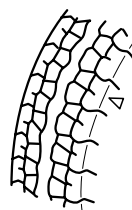

New tread

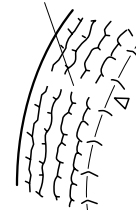

Worn tread

Tread wear indicator

You should replace it before the band is across the entire tread.



## Owner Maintenance

### NOTE

*Tires degrade over time, even when they are not being used on the road. It is recommended that tires generally be replaced when they are 6 years or older. Heat caused by hot climates or frequent high loading conditions can accelerate the aging process. You should replace the spare tire when you replace the other road tires due to the aging of the spare tire. Regarding the manufacturing week and year is indicated with 4 digit. Refer to The tire labeling on page 9-23.*

### ▼ Temporary Spare Tire

Inspect the temporary spare tire at least monthly to make sure it's properly inflated and stored.

### NOTE

*The temporary spare tire condition gradually deteriorates even if it has not been used.*

The temporary spare tire is easier to handle because of its construction which is lighter and smaller than a conventional tire. This tire should be used only for an emergency and only for a short distance.

Use the temporary spare tire only until the conventional tire is repaired, which should be as soon as possible.

### (Except Mexico)

Maintain its pressure at 420 kPa (4.2 bar, 60 psi).

### (Mexico)

Maintain its pressure at 250 kPa (2.5 bar, 36 psi).

### ⚠ CAUTION

- Do not use your temporary spare tire rim with a snow tire or a conventional tire. Neither will properly fit and could damage both tire and rim.
- The temporary spare tire has a tread life of less than 5,000 km (3,000 miles). The tread life may be shorter depending on driving conditions.
- The temporary spare tire is for limited use, however, if the tread wear solid-band indicator appears, replace the tire with the same type of temporary spare (page 8-36).

### NOTE

*Tires degrade over time, even when they are not being used on the road. It is recommended that tires generally be replaced when they are 6 years or older. Heat caused by hot climates or frequent high loading conditions can accelerate the aging process. You should replace the spare tire when you replace the other road tires due to the aging of the spare tire. Regarding the manufacturing week and year is indicated with 4 digit. Refer to The tire labeling on page 9-23.*

### ▼ Replacing a Wheel

### ⚠ WARNING

**Always use wheels of the correct size on your vehicle:**

*Using a wrong-sized wheel is dangerous. Braking and handling could be affected, leading to loss of control and an accident.*

Maintenance and Care

## Owner Maintenance

---

### CAUTION

- A wrong-sized wheel may adversely affect:
  - Tire fit
  - Wheel and bearing life
  - Ground clearance
  - Snow-chain clearance
  - Speedometer calibration
  - Headlight aim
  - Bumper height
  - Tire Pressure Monitoring System
  - Limited-Slip Differential System
- **(With Tire Pressure Monitoring System)**
  - When replacing/repairing the tires or wheels or both, have the work done by an Authorized Mazda Dealer, or the tire pressure sensors may be damaged.
  - The wheels equipped on your Mazda are specially designed for installation of the tire pressure sensors. Do not use non-genuine wheels, otherwise it may not be possible to install the tire pressure sensors.

### NOTE

Be sure to install the tire pressure sensors whenever tires or wheels are replaced. Refer to *Tires and Wheels* on page 5-31.

When replacing a wheel, make sure the new one is the same as the original factory wheel in diameter, rim width, and offset.

Proper tire balancing provides the best riding comfort and helps reduce tread wear. Out-of-balance tires can cause vibration and uneven wear, such as cupping and flat spots.

Maintenance and Care  
**Owner Maintenance**

**Light Bulbs**

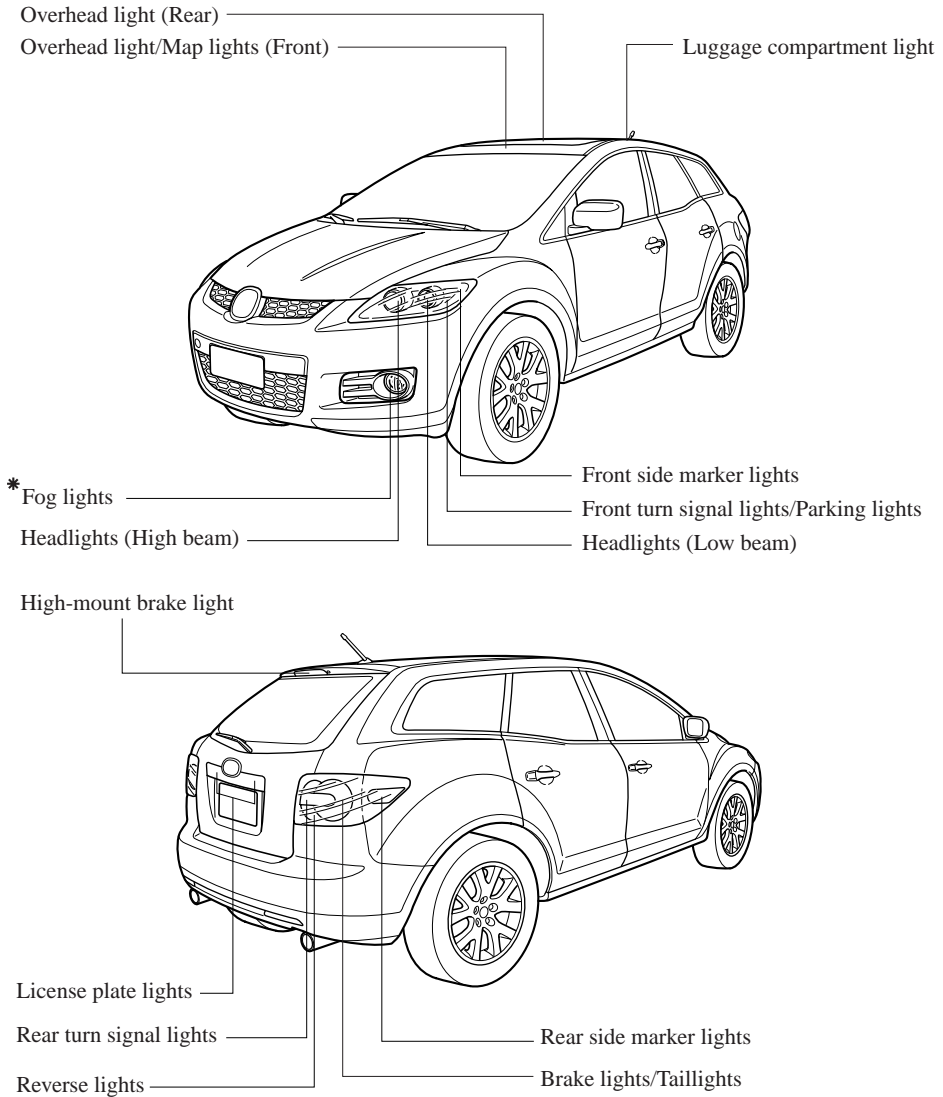

\*Some models.

Maintenance and Care

## Owner Maintenance

### **⚠ WARNING**

**Do not replace the xenon fusion bulbs yourself:**

*Replacing the xenon fusion bulbs yourself is dangerous. Because the xenon fusion bulbs require high voltage, you could receive an electric shock if the bulbs are handled incorrectly. Consult an Authorized Mazda Dealer when the replacement is necessary.*

**Never touch the glass portion of a halogen bulb with your bare hands and always wear eye protection when handling or working around the bulbs:**

*When a halogen bulb breaks, it is dangerous. These bulbs contain pressurized gas. If one is broken, it will explode and serious injuries could be caused by the flying glass. If the glass portion is touched with bare hands, body oil could cause the bulb to overheat and explode when lit.*

**Always keep halogen bulbs out of the reach of children:**

*Playing with a halogen bulb is dangerous. Serious injuries could be caused by dropping a halogen bulb or breaking it some other way.*

### ▼ Replacing Exterior Light Bulbs

#### Replacing a headlight bulb

##### High-beam bulb

1. Make sure the ignition switch is turned off and the headlight switch is off.
2. Lift the hood.

3. Turn the socket and bulb assembly counterclockwise and remove it. Carefully remove the High-beam bulb from its socket in the reflector by gently pulling it straight backward out of the socket.
4. Disconnect the bulb from the electrical connector by pressing the tab on the connector with your finger and pulling the bulb upward.

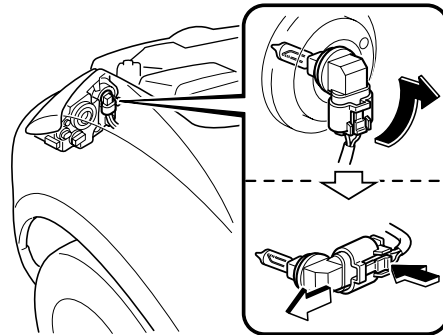

5. Install the new bulb in the reverse order of removal.

#### **NOTE**

- To replace the bulb, contact an Authorized Mazda Dealer.
- If the halogen bulb is accidentally touched, it should be cleaned with rubbing alcohol before being used.
- Use the protective cover and carton of the replacement bulb to dispose of the old bulb promptly out of the reach of children.

#### **Low-beam bulb**

##### **(Xenon fusion bulb)**

You cannot replace the low beam bulbs by yourself.

The bulbs must be replaced at an Authorized Mazda Dealer.

##### **(Halogen bulbs)**

1. Make sure the headlight switch is off.

Maintenance and Care  
**Owner Maintenance**

2. If you are changing the right Low-beam bulb, start the engine, turn the steering wheel all the way to the right, and turn off engine. If you are changing the left Low-beam bulb, turn the steering wheel to the left.
3. Turn the screws and the center section of the plastic retainers counterclockwise and remove them, then partially peel back the mudguard.

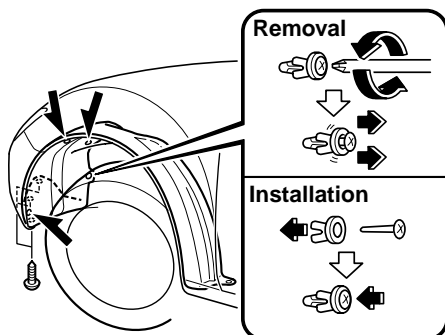

4. Detach the electrical connector from the bulb by pulling it to the rear.

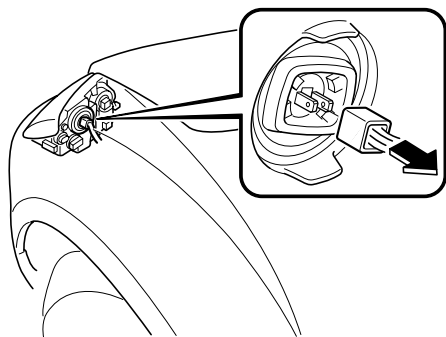

5. Pull off the sealing cover.
6. Unhook the bulb retaining spring.

7. Swing the retaining spring out and away to free the bulb.

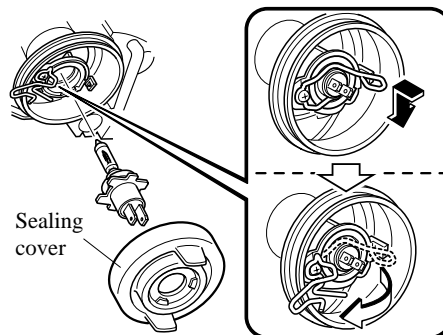

8. Carefully remove the bulb from the socket by pulling it straight back.

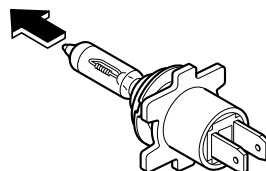

9. Replace the bulb.
10. Install the new bulb in the reverse order of removal.

**NOTE**

- To replace the bulb, contact an Authorized Mazda Dealer.
- If the halogen bulb is accidentally touched, it should be cleaned with rubbing alcohol before being used.
- Use the protective cover and carton for the replacement bulb to dispose of the old bulb promptly and out of the reach of children.

Maintenance and Care

## Owner Maintenance

### Front side marker lights, Front turn signal lights/Parking lights

1. Make sure the headlight switch is off.
2. If you are changing a bulb in the right headlight unit, start the engine, turn the steering wheel all the way to the right, and turn off engine. If you are changing a bulb in the left headlight unit, turn the steering wheel to the left.
3. Turn the screws and the center section of the plastic retainers counterclockwise and remove them, then partially peel back the mudguard.

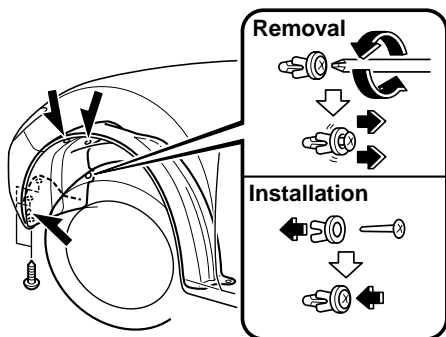

4. Turn the socket and bulb assembly counterclockwise and remove it.
5. Disconnect the bulb from the socket.

### Front side marker lights

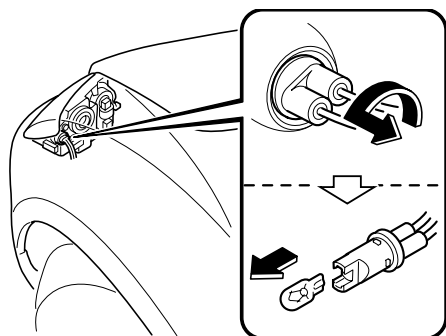

### Front turn signal lights/Parking lights

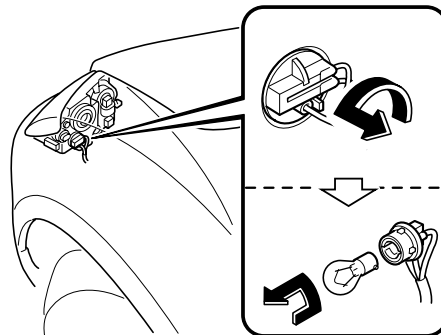

6. Install the new bulb in the reverse order of removal.

### Fog lights \*

1. Make sure the headlight switch is off.
2. If you are changing the right fog light bulb, start the engine, turn the steering wheel all the way to the right, and turn off engine. If you are changing the left fog light bulb, turn the steering wheel to the left.
3. Turn the screws and the center section of the plastic retainers counterclockwise and remove them, then partially peel back the mudguard.

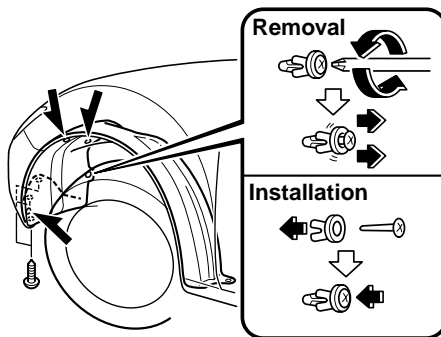

Maintenance and Care  
**Owner Maintenance**

4. Disconnect the electrical connector from the bulb by pressing the tab on the connector with your finger and pulling the connector downward.
5. Turn the socket and bulb assembly counterclockwise and remove it. Carefully remove the bulb from its socket in the reflector by gently pulling it straight backward out of the socket.

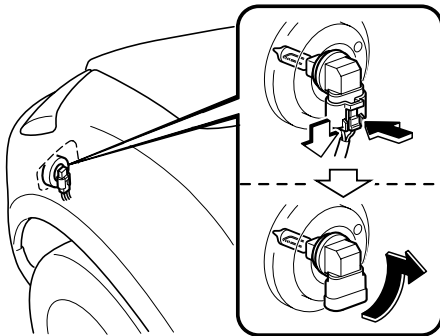

6. Install the new bulb in the reverse order of removal.

**NOTE**

- To replace the bulb, contact an Authorized Mazda Dealer.
- If the halogen bulb is accidentally touched, it should be cleaned with rubbing alcohol before being used.
- Use the protective cover and carton for the replacement bulb to dispose of the old bulb promptly and out of the reach of children.

**Brake lights/Taillights, Rear turn signal lights, Reverse lights, Rear side-marker lights**

1. Remove the cover.

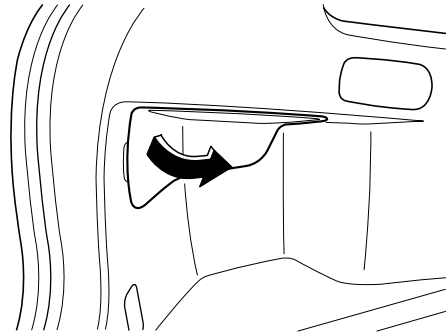

2. Turn the socket and bulb assembly counterclockwise and remove it.
3. Disconnect the bulb from the socket.

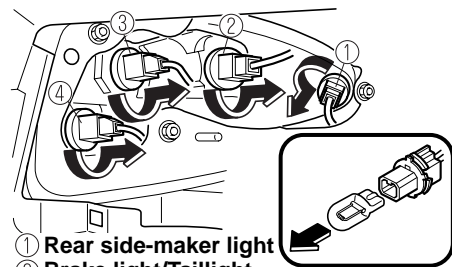

- ① Rear side-marker light
- ② Brake light/Taillight
- ③ Rear direction indication light
- ④ Reverse light

4. Install the new bulb in the reverse order of removal.

**NOTE**

To replace the bulb, contact an Authorized Mazda Dealer.

**High-mount brake light**

Due to the complexity and difficulty of the procedure, the LED bulbs should be replaced by an Authorized Mazda Dealer.

Maintenance and Care

## Owner Maintenance

### NOTE

LED bulb replacement is not possible. The rear combination component must be replaced.

### License plate lights

1. Wrap a flathead screwdriver with a soft cloth to prevent damage to the lens and remove the lens by carefully prying on the edge of the lens with a flathead screwdriver.
2. Disconnect the bulb by pulling it out.

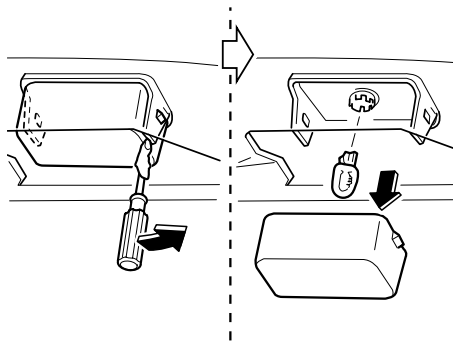

3. Install the new bulb in the reverse order of removal.

### ▼ Replacing Interior Light Bulbs

#### Overhead light/Map lights (Front)

Due to the complexity and difficulty of the procedure, the bulbs should be replaced by an Authorized Mazda Dealer.

#### Overhead light (Rear), Luggage compartment light

1. Wrap a small flathead screwdriver with a soft cloth to prevent damage to the lens and remove the lens by carefully prying on the edge of the lens with the flathead screwdriver.

2. Disconnect the bulb by pulling it out.

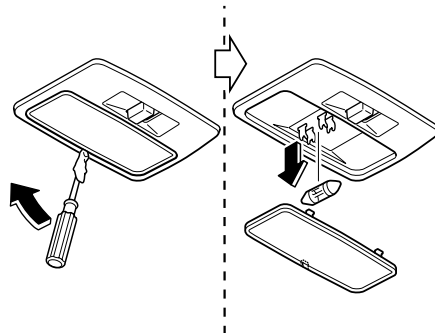

3. Install the new bulb in the reverse order of removal.



Maintenance and Care  
**Owner Maintenance**

## Fuses

Your vehicle's electrical system is protected by fuses.

If any lights, accessories, or controls don't work, inspect the appropriate circuit protector. If a fuse has blown, the inside element will be melted.

If the same fuse blows again, avoid using that system and consult an Authorized Mazda Dealer as soon as possible.

### ▼ Fuse Replacement

#### Replacing the fuses on the driver's side

If the electrical system does not work, first inspect the fuses on the driver's side.

1. Turn off the ignition switch and other switches.
2. Open the fuse panel cover.

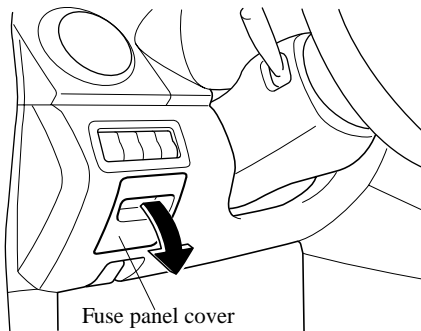

3. Pull the fuse straight out with the fuse puller provided on the inside of the cover for the fuse panel and the fuse block cover inside of the engine compartment.

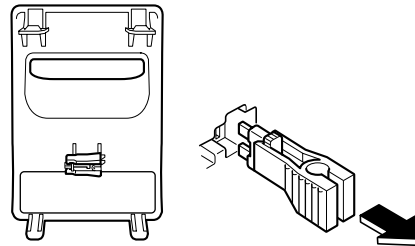

4. Inspect the fuse and replace it if it's blown.

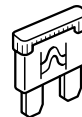

Normal



Blown

5. Insert a new fuse of the same amperage rating, and make sure it fits tightly. If it does not fit tightly, have an expert install it. We recommend an Authorized Mazda Dealer.  
If you have no spare fuses, borrow one of the same rating from a circuit not essential to vehicle operation, such as the ROOM circuit.

Maintenance and Care

## Owner Maintenance

### **CAUTION**

*Always replace a fuse with one of the same rating. Otherwise you may damage the electric system.*

### **Replacing the fuses under the hood**

If the headlights or other electrical components do not work and the fuses in the cabin are normal, inspect the fuse block under the hood. If a fuse is blown, it must be replaced. Follow these steps:

1. Turn off the ignition switch and all other switches.
2. Remove the fuse block cover.

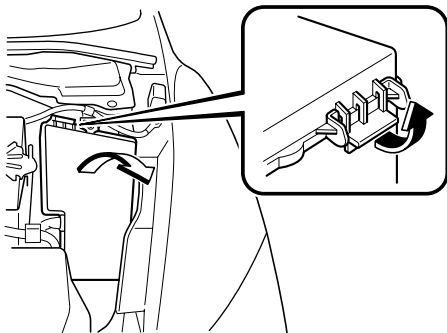

3. Pull the fuse straight out with the fuse puller provided on the inside of the engine compartment fuse block cover.

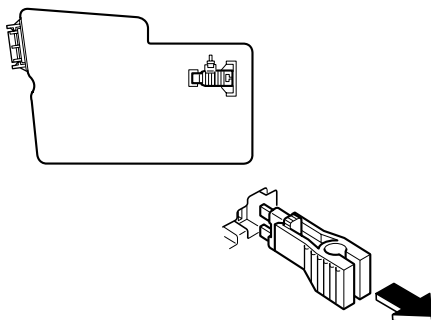

4. If any fuse but the MAIN fuse is blown, replace it with a new one of the same amperage rating.

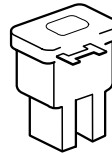

Normal

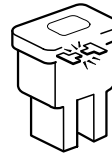

Blown

### **WARNING**

**Do not replace the main fuse by yourself. Have an Authorized Mazda Dealer perform the replacement:**

*Replacing the fuse by yourself is dangerous because the MAIN fuse is a high current fuse. Incorrect replacement could cause an electrical shock or a short circuit resulting in a fire.*

Maintenance and Care  
**Owner Maintenance**

▼ **Fuse Panel Description**

**Fuse block (Engine compartment)**

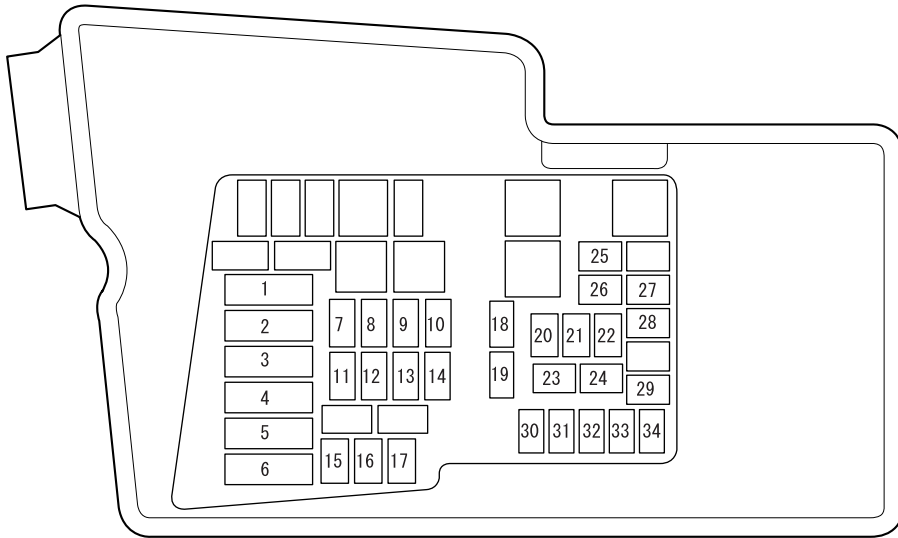

DESCRIPTION	FUSE RATING	PROTECTED COMPONENT	
1	IGN 2	40A	Ignition system
2	BLOWER	40A	Blower motor
3	BTN	60A	For protection of various circuits
4	FAN 2	40A	Cooling fan
5	IGN 1	40A	Ignition system
6	FAN 1	40A	Cooling fan
7	P.SEAT	40A	Power seat *
8	INJ	30A	Injector
9	ROOF	20A	Moonroof *
10	BOSE	30A	Bose audio system *
11	ENGINE	30A	Engine control system
12	D.LOCK	20A	Power door locks
13	P.WIND	30A	Power windows
14	FUEL	30A	Fuel pump
15	ABS 1	40A	ABS
16	ABS 2	20A	ABS
17	DSC	7.5A	DSC
18	FOG	20A	Fog lights *

\*Some models. **8-47**

Maintenance and Care

# Owner Maintenance

	DESCRIPTION	FUSE RATING	PROTECTED COMPONENT
19	DEF	30A	Rear window defroster
20	TNS	15A	Parking lights, License plate lights, Illuminated entry system
21	A/C	10A	Air conditioner *
22	ETC	20A	Accelerator position sensor
23	H/L HI	15A	Headlight leveling *
24	DRL	15A	DRL *
25	H/L LO RH	15A	Headlight low beam (RH)
26	H/L LO LH	15A	Headlight low beam (LH)
27	ENG BAR 2	7.5A	PCM
28	ECM	10A	Engine control system
29	ENG BAR 1	15A	Air flow sensor, EGR control valve
30	P.WIND 2	20A	Power windows
31	STOP	10A	Brake lights
32	HORN	20A	Horn
33	ENG B+	25A	PCM
34	HAZARD	10A	Hazard warning flashers, Turn signals

### Fuse block (Driver's side)

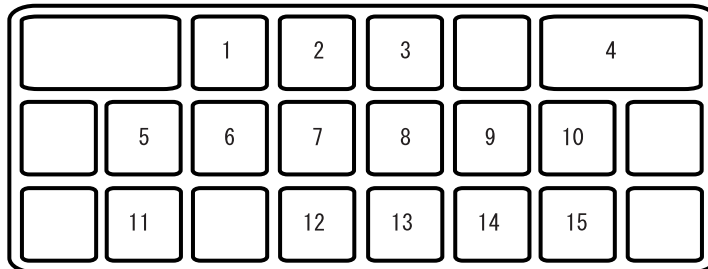

	DESCRIPTION	FUSE RATING	PROTECTED COMPONENT
1	OUTLET 1	15A	Accessory Socket

**8-48** \*Some models.

Maintenance and Care  
**Owner Maintenance**

	DESCRIPTION	FUSE RATING	PROTECTED COMPONENT
2	OUTLET 2	15A	Accessory Socket
3	P.MIR	7.5A	Power control mirror
4	WIPER	30A	Windshield wiper and washer
5	M.DEF	7.5A	Mirror defroster *
6	ENG BAR 3	7.5A	Air flow sensor, EGR control valve
7	P.WIND	15A	Power windows
8	A/B	7.5A	Advance Restraint System
9	ENGINE	15A	Engine control system
10	METER	10A	Instrument cluster
11	ROOM	15A	Audio system, Overhead light
12	ILLUMI	10A	Dashboard illumination
13	SEAT	20A	Seat warmer *
14	A/C	10A	Air conditioner *
15	R.WIP	10A	Rear window wiper and washer

\*Some models. **8-49**

Maintenance and Care

## Appearance Care

### How to Minimize Environmental Paint Damage

The paintwork on your Mazda represents the latest technical developments in composition and methods of application.

Environmental hazards, however, can harm the paint's protective properties, if proper care is not taken.

Here are some examples of possible damage, with tips on how to prevent them.

#### ▼ Etching Caused by Acid Rain or Industrial Fallout

##### Occurrence

Industrial pollutants and vehicle emissions drift into the air and mix with rain or dew to form acids. These acids can settle on a vehicle's finish. As the water evaporates, the acid becomes concentrated and can damage the finish.

And the longer the acid remains on the surface, the greater the chance is for damage.

##### Prevention

It is necessary to wash and wax your vehicle to preserve its finish according to the instructions in this section. These steps should be taken immediately after you suspect that acid rain has settled on your vehicle's finish.

#### ▼ Damage Caused by Bird Dropping, Insects, or Tree Sap

##### Occurrence

Bird droppings contain acids. If these aren't removed they can eat away the clear and color base coat of the vehicle's paintwork.

When insects stick to the paint surface and decompose, corrosive compounds form. These can erode the clear and color base coat of the vehicle's paintwork if they are not removed.

Tree sap will harden and adhere permanently to the paint finish. If you scratch the sap off while it is hard, some vehicle paint could come off with it.

##### Prevention

It is necessary to have your Mazda washed and waxed to preserve its finish according to the instructions in this section. This should be done as soon as possible.

Bird droppings can be removed with a soft sponge and water. If you are traveling and these are not available, a moistened tissue may also take care of the problem. The cleaned area should be waxed according to the instructions in this section.

Insects and tree sap are best removed with a soft sponge and water or a commercially available chemical cleaner.

Another method is to cover the affected area with dampened newspaper for one to two hours. After removing the newspaper, rinse off the loosened debris with water.

## Appearance Care

### ▼ Water Marks

#### Occurrence

Rain, fog, dew, and even tap water can contain harmful minerals such as salt and lime. If moisture containing these minerals settles on the vehicle and evaporates, the minerals will concentrate and harden to form white rings. The rings can damage your vehicle's finish.

#### Prevention

It is necessary to wash and wax your vehicle to preserve its finish according to the instructions in this section. These steps should be taken immediately after you find water marks on your vehicle's finish.

### ▼ Paint Chipping

#### Occurrence

Paint chipping occurs when gravel thrown in the air by another vehicle's tires hits your vehicle.

#### How to avoid paint chipping

Keeping a safe distance between you and the vehicle ahead reduces the chances of having your paint chipped by flying gravel.

#### **NOTE**

- *The paint chipping zone varies with the speed of the vehicle. For example, when traveling at 90 km/h (56 mph), the paint chipping zone is 50 m (164 ft).*
- *In low temperatures a vehicle's finish hardens. This increases the chance of paint chipping.*
- *Chipped paint can lead to rust forming on your Mazda. Before this happens, repair the damage by using Mazda touch-up paint according to the instructions in this section. Failure to repair the affected area could lead to serious rusting and expensive repairs.*

Maintenance and Care

## Appearance Care

### Exterior Care

Follow **all** label and container directions when using a chemical cleaner or polish. Read all warnings and cautions.

#### ▼ Maintaining the Finish

##### Washing

To help protect the finish from rust and deterioration, wash your Mazda thoroughly and frequently, at least once a month, with lukewarm or cold water.

If the vehicle is washed improperly, the paint surface could be scratched. Here are some examples of how scratching could occur.

Scratches occur on the paint surface when:

- The vehicle is washed without first rinsing off dirt and other foreign matter.
- The vehicle is washed with a rough, dry, or dirty cloth.
- The vehicle is washed at a car wash that uses brushes that are dirty or too stiff.
- Cleansers or wax containing abrasives are used.

##### **NOTE**

- *Mazda is not responsible for scratches caused by automatic car washes or improper washing.*
- *Scratches are more noticeable on vehicles with darker paint finishes.*

To minimize scratches on the vehicle's paint finish:

- Rinse off any dirt or other foreign matter using lukewarm or cold water before washing.

- Use plenty of lukewarm or cold water and a soft cloth when washing the vehicle. Do not use a nylon cloth.
- Rub gently when washing or drying the vehicle.
- Take your vehicle only to a car wash that keeps its brushes well maintained.
- Don't use abrasive cleansers or wax that contain abrasives.

#### **CAUTION**

- *Don't use steel wool, abrasive cleaners, or strong detergents containing highly alkaline or caustic agents on chrome-plated or anodized aluminum parts. This may damage the protective coating; also, cleaners and detergents may discolor or deteriorate the paint.*
- *To prevent damaging the antenna, remove it before entering a car wash facility or passing beneath a low overhead clearance.*

Pay special attention to removing salt, dirt, mud, and other foreign material from the underside of the fenders, and make sure the drain holes in the lower edges of the doors and rocker panels are clean.

Insects, tar, tree sap, bird droppings, industrial fallout, and similar deposits can damage the finish if not removed immediately. When prompt washing with plain water is ineffective, use a mild soap made for use on vehicles.

Thoroughly rinse off all soap with lukewarm or cold water. Don't allow soap to dry on the finish.



## Appearance Care

After washing the vehicle, dry it with a clean chamois to prevent water spots from forming.

### **WARNING**

***Dry wet brakes by driving very slowly and applying the brakes lightly until brake performance is normal:***

*Driving with wet brakes is dangerous. Increased stopping distance or the vehicle pulling to one side when braking could result in a serious accident. Light braking will indicate whether the brakes have been affected.*

### **Waxing**

Your vehicle needs to be waxed when water no longer beads on the finish. Always wash and dry the vehicle before waxing it. In addition to the vehicle body, wax the metal trim to maintain its luster.

1. Use wax which contains no abrasives. Waxes containing abrasive will remove paint and could damage bright metal parts.
2. Use a good grade of natural wax for metallic, mica, and solid colors.
3. When waxing, coat evenly with the sponge supplied or a soft cloth.
4. Wipe off the wax with a soft cloth.

### ***NOTE***

*A spot remover to remove oil, tar, and similar materials will usually also take off the wax. Rewax these areas even if the rest of the vehicle doesn't need it.*

### **▼ Repairing Damage to the Finish**

Deep scratches or chips on the finish should be repaired promptly. Exposed metal quickly rusts and can lead to major repairs.

### **CAUTION**

*If your Mazda is damaged and needs metal parts repaired or replaced, make sure the body shop applies anti-corrosion materials to all parts, both repaired and new. This will prevent them from rusting.*

### **▼ Paint Damage Touch-up**

Repair damage to the finish caused by stone chipping, damage during parking etc., by using Mazda touch-up paint before rust begins to form. First, remove the dirt and grease with a clean soft cloth.

If rust has already begun to form:

1. Remove rust completely with sandpaper.
2. Wipe with a clean soft cloth.
3. Apply rust preventive primer to the area.
4. After drying it completely, apply a suitable top coat material to the area.

Of course there will be no problem if you assign the work to an Authorized Mazda Dealer.

Maintenance and Care

## Appearance Care

### ▼ Cavity Protection

Cavities are treated for protection at the factory, but additional protective treatment after the vehicle has been put into use will extend the life of the body.

We recommend that you consult an Authorized Mazda Dealer concerning this additional precaution.

### ▼ Bright-Metal Maintenance

- Use tar remover to remove road tar and insects. Never do this with a knife or similar tool.
- To prevent corrosion on bright-metal surfaces, apply wax or chrome preservative and rub it to a high luster.
- During cold weather or in coastal areas, cover bright-metal parts with a coating of wax or preservative heavier than usual. It would also help to coat them with noncorrosive petroleum jelly or some other protective compound.

#### CAUTION

*Don't use steel wool, abrasive cleaners, or strong detergents containing highly alkaline or caustic agents on chrome-plated or anodized aluminum parts. This may result in damage to the protective coating and cause discoloration or paint deterioration.*

### ▼ Underbody Maintenance

Road chemicals and salt used for ice and snow removal and solvents used for dust control may collect on the underbody. If not removed, they will speed up rusting and deterioration of such underbody parts as fuel lines, frame, floor pan, and exhaust system, even though these parts may be coated with anti-corrosive material.

Thoroughly flush the underbody and wheel housings with lukewarm or cold water at the end of each winter. Try also to do this every month.

Pay special attention to these areas because they easily hide mud and dirt. **It will do more harm than good to wet down the road grime without removing it.**

The lower edges of doors, rocker panels, and frame members have drain holes that should not be clogged. Water trapped there will cause rusting.

#### WARNING

***Dry wet brakes by driving very slowly and applying the brakes lightly until brake performance is normal:***

*Driving with wet brakes is dangerous. Increased stopping distance or the vehicle pulling to one side when braking could result in a serious accident. Light braking will indicate whether the brakes have been affected.*

## Appearance Care

### ▼ Undercoating

This special coating is applied to the critical parts of the underside to protect vehicles from damage caused by chemicals or stones. This coating is liable to be damaged with time. Check this coating periodically.

An Authorized Mazda Dealer are well informed on how repairs should be made. Consult an Authorized Mazda Dealer.

### ▼ Aluminum Wheel Maintenance

A protective coating is provided over the aluminum wheels. Special care is needed to protect this coating.

#### NOTE

- *Don't use a wire brush or any abrasive cleaner, polishing compound, or solvent on aluminum wheels. They may damage the coating.*
- *Only use a mild soap or neutral detergent and always use a sponge or soft cloth to clean the wheels.  
Rinse thoroughly with lukewarm or cold water. Also, be sure to clean the wheels after driving on dusty or salted roads. This helps prevent corrosion.*
- *Avoid washing your vehicle in an automatic car wash that uses high-speed or hard brushes.*
- *If your aluminum wheels lose luster, wax the wheels.*

## Interior Care

### ▼ Dashboard Precautions

Prevent caustic solutions such as perfume and cosmetic oils from contacting the dashboard. They'll damage and discolor it. If these solutions get on the dashboard, wipe them off immediately.

#### CAUTION

*Do not use glazing agents. Glazing agents contain ingredients which may cause discoloration, wrinkling, cracks and peeling.*

### ▼ Cleaning the Upholstery and Interior Trim

#### Vinyl

Remove dust and loose dirt from vinyl with a whisk broom or vacuum cleaner. Clean vinyl with a leather-and-vinyl cleaner.

#### Leather\*

Real leather isn't uniform and may have scars, scratches, and wrinkles. Clean it with a leather cleaner or mild soap.

Wipe it with a **damp** soft cloth; then dry and buff it with a **dry** soft cloth.

#### Fabric

Remove dust and loose dirt from fabric with a whisk broom or vacuum cleaner. Clean it with a mild soap solution good for upholstery and carpets. Remove fresh spots immediately with a fabric spot cleaner.

Maintenance and Care

## Appearance Care

To keep the fabric looking clean and fresh, take care of it. Otherwise its color will be affected, it can be stained easily, and its fire-resistance may be reduced.

### **CAUTION**

*Use only recommended cleaners and procedures. Others may affect appearance and fire-resistance.*

#### **Piano black panel\***

The following parts are fitted with panels that have been treated with a special coating that resists scratching.

Steering wheel (partial)

When the panel needs to be cleaned, use a soft cloth to wipe off dirt from the surface.

#### **NOTE**

*Scratches or nicks on the panels resulting from the use of a hard brush or cloth may not be repairable.*

#### **▼ Cleaning the Lap/Shoulder Belt Webbing**

Clean the webbing with a mild soap solution recommended for upholstery or carpets. Follow instructions. Don't bleach or dye the webbing; this may weaken it.

After cleaning the belts, thoroughly dry the belt webbing and make sure there is no remaining moisture before retracting them.

### **WARNING**

**Have an Authorized Mazda Dealer replace damaged seat belts immediately:**

*Using damaged seat belts is dangerous. In a collision, damaged belts cannot provide adequate protection.*

#### **▼ Cleaning the Window Interiors**

If the windows become covered with an oily, greasy, or waxy film, clean them with glass cleaner. Follow the directions on the container.

### **CAUTION**

*Don't scrape or scratch the inside of the rear window. You may damage the rear window defroster grid.*

# 9

## Customer Information and Reporting Safety Defects

Important consumer information including warranties and add-on equipment.

<b>Customer Assistance .....</b>	<b>9-2</b>	<b>Tire Information (except Canada) .....</b>	<b>9-23</b>
Customer Assistance (U.S.A.) .....	9-2	Tire Labeling .....	9-23
Customer Assistance (Canada) .....	9-5	Location of the Tire Label (Placard) .....	9-29
Customer Assistance (Puerto Rico) ....	9-8	Tire Maintenance .....	9-32
Customer Assistance (Mexico) .....	9-9	Vehicle Loading .....	9-35
 		Steps for Determining the Correct Load Limit: .....	9-42
<b>Mazda Importer/Distributors .....</b>	<b>9-11</b>	 	
Importer/Distributor .....	9-11	<b>Reporting Safety Defects .....</b>	<b>9-43</b>
Distributor in Each Area .....	9-11	Reporting Safety Defects (U.S.A.) ....	9-43
 		Reporting Safety Defects (Canada) ...	9-44
<b>Warranty .....</b>	<b>9-13</b>	 	
Warranties for Your Mazda .....	9-13	<b>Service Publications .....</b>	<b>9-45</b>
Outside the United States and Canada .....	9-14	Service Publications .....	9-45
Outside the United States .....	9-15		
Outside Canada .....	9-16		
Registering Your Vehicle in A Foreign Country (Except United States and Canada) .....	9-17		
Add-On Non-Genuine Parts and Accessories .....	9-18		
<b>Cell Phones .....</b>	<b>9-19</b>		
Cell Phones Warning .....	9-19		
<b>Type Approval of Equipment .....</b>	<b>9-20</b>		
Type Approval of Equipment (Mexico) .....	9-20		
<b>Uniform Tire Quality Grading System (UTQGS) .....</b>	<b>9-21</b>		
Uniform Tire Quality Grading System (UTQGS) .....	9-21		

Customer Information and Reporting Safety Defects

## Customer Assistance

### Customer Assistance (U.S.A.)

Your complete and permanent satisfaction is our business. We are here to serve you. All Authorized Mazda Dealers have the knowledge and the tools to keep your Mazda vehicle in top condition.

If you have any questions or recommendations for improvement regarding the service of your Mazda vehicle or servicing by Mazda Dealer personnel, we recommend that you take the following steps:

#### **NOTE**

*If it becomes necessary to have the components or wiring system for the supplementary restraint system modified to accommodate a person with certain medical conditions in accordance with a certified physician, contact an Authorized Mazda Dealer.*

#### **▼STEP 1: Contact Your Mazda Dealer**

Discuss the matter with an Authorized Mazda Dealer. This is the quickest and best way to address the issue.

- If your concern has not been resolved by the CUSTOMER RELATIONS, SALES, SERVICE, or PARTS MANAGER, then please contact the GENERAL MANAGER of the dealership or the OWNER.
- If it becomes necessary to have the components or wiring system for the supplementary restraint system modified to accommodate a person with certain medical conditions in accordance with a certified physician, go to STEP2.

#### **▼STEP 2: Contact Mazda North American Operations**

If for any reason you feel the need for further assistance after contacting your dealership management and it becomes necessary to have the components or wiring system for the supplementary restraint system modified to accommodate a person with certain medical conditions in accordance with a certified physician, you can reach Mazda North American Operations by one of the following ways.

Log on: at [www.mazdaUSA.com](http://www.mazdaUSA.com)

Answers to many questions, including how to locate or contact a local Mazda dealership in the U.S., can be found here.

E-mail: click on "Contact Us" at the bottom of the page at [www.mazdaUSA.com](http://www.mazdaUSA.com)

By phone at: 1 (800) 222-5500

## Customer Assistance

---

By letter at:

Attn: Customer Assistance  
Mazda North American Operations  
7755 Irvine Center Drive  
Irvine, CA 92618-2922  
P.O. Box 19734  
Irvine, CA 92623-9734

In order to serve you efficiently and effectively, please help us by providing the following information:

1. Your name, address, and telephone number
2. Year and model of vehicle
3. Vehicle Identification Number (17 digits, noted on your registration or title or located on the upper driver's side corner of the dash)
4. Purchase date and current mileage
5. Your dealer's name and location
6. Your question(s)

If you live outside the U.S.A., please contact your nearest Mazda Distributor.

### ▼STEP 3: Contact Better Business Bureau (BBB)

Mazda North American Operations realizes that mutual agreement on some issues may not be possible. As a final step to ensure that your concerns are being fairly considered, Mazda North American Operations has agreed to participate in a dispute settlement program administered by the Better Business Bureau (BBB) system, at no cost to you the consumer.

BBB AUTO LINE works with consumers and the manufacturer in an attempt to reach a mutually acceptable resolution of any warranty related concerns. If the BBB is not able to facilitate a settlement they will provide an informal hearing before an arbitrator.

You are required to resort to BBB AUTO LINE before exercising rights or seeking remedies under the Federal Magnuson-Moss Warranty Act, 15 U.S.C. § 2301 et seq. To the extent permitted by the applicable state "Lemon Law", you are also required to resort to BBB AUTO LINE before exercising any rights or seeking remedies under the "Lemon Law". If you choose to seek remedies that are not created by the Magnuson-Moss Warranty Act or the applicable state "Lemon Law", you are not required to first use BBB AUTO LINE.

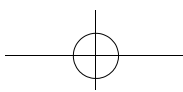

Customer Information and Reporting Safety Defects

## Customer Assistance

---

The whole process normally takes 40 days or less. The arbitration decision is not binding on you or Mazda else you accept the decision. For more information about BBB AUTO LINE, including current eligibility standards, please call 1-800-955-5100 or visit the BBB website at [www.lemonlaw.bbb.org](http://www.lemonlaw.bbb.org).

Being truly committed to customer satisfaction is more than a phrase with Mazda. We hope to satisfy every customer directly, but if there is ever a question about our decision, Mazda believes in providing a fast, fair and free method such as the BBB AUTO LINE to ensure Mazda delivers on our commitment to do the right thing for our customers!

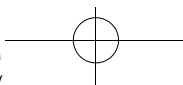



## Customer Assistance

### Customer Assistance (Canada)

#### ▼ Satisfaction Review Process

Your complete and permanent satisfaction is of primary concern to Mazda. All Authorized Mazda Dealers have both the knowledge and tools to keep your Mazda in top condition. In our experience, any questions, problems, or complaints regarding the operation of your Mazda or any other general service transactions are most effectively resolved by your dealer. If the cause of your dissatisfaction cannot adequately be addressed by normal dealership procedures, we recommend that you take the following steps:

#### ▼ STEP 1: Contact the Mazda Dealer

Discuss the matter with a member of dealership management. If the Service Manager has already reviewed your concerns, contact the owner of the dealership or its General Manager.

#### ▼ STEP 2: Contact the Mazda Regional Office

If you feel that you still require assistance, ask the dealer Service Manager to arrange for you to meet the local Mazda Service Representative. If more expedient, contact Mazda Canada Inc. Regional Office nearest you for such arrangements. Regional Office address and phone numbers are shown (page 9-7).

#### ▼ STEP 3: Contact the Mazda Customer Relations Department

If still not substantially satisfied, contact the Customer Relations Department, Mazda Canada Inc., 55 Vogell Road, Richmond Hill, Ontario, L4B 3K5 Canada TEL: 1 (800) 263-4680.

Provide the Department with the following information:

1. Your name, address and telephone number
2. Year and model of vehicle
3. Vehicle Identification Number (VIN). Refer to the "Vehicle Identification Labels" page of section 10 of this manual for the location of the VIN.
4. Purchase date
5. Present odometer reading
6. Your dealer's name and location
7. The nature of your problem and/or cause of dissatisfaction

The Department, in cooperation with the local Mazda Service Representative, will review the case to determine if everything possible has been done to ensure your satisfaction.

Customer Information and Reporting Safety Defects

## Customer Assistance

---

Please recognize that the resolution of service problems in most cases requires the use of your Mazda dealer's service facilities, personnel and equipment. We urge you to follow the above three steps in sequence for most effective results.

### ▼ Mediation/Arbitration Program

Occasionally a customer concern cannot be resolved through Mazda's Customer Satisfaction Program. If after exhausting the procedures in this manual your concern is still not resolved, you have another option.

Mazda Canada Inc. participates in an arbitration program administered by the Canadian Motor Vehicle Arbitration Plan (CAMVAP). CAMVAP will advise you about how your concern may be reviewed and resolved by an independent third party through binding arbitration.

Your complete satisfaction is the goal of Mazda Canada Inc. and our dealers. Mazda's participation in CAMVAP makes a valuable contribution to our achieving that goal. There is no charge for using CAMVAP. CAMVAP results are fast, fair and final as the award is binding on both you and Mazda Canada Inc.

### ▼ Canadian Motor Vehicle Arbitration Plan (CAMVAP)

If a specific item of concern arises, where a solution cannot be reached between an owner, Mazda, and/or one of its dealers (that all parties cannot agree upon), the owner may wish to use the services offered by the Canadian Motor Vehicle Arbitration Plan (CAMVAP).

CAMVAP uses the services of Provincial Administrators to assist consumers in scheduling and preparing for their arbitration hearings. However, before you can proceed with CAMVAP you must follow your Mazda dispute resolution process as outlined previously.

Customer Information and Reporting Safety Defects

**Customer Assistance**

CAMVAP is fully implemented in all provinces and territories. Consumers wishing to obtain further information about the Program should contact the Provincial Administrator at 1 (800) 207-0685, or by contacting the Canadian Motor Vehicle Arbitration Plan Office at:

Canadian Motor Vehicle Arbitration Plan  
 235 Yorkland Boulevard, suite 300  
 North York, Ontario  
 M2J 4Y8  
<http://camvap.ca>

Provincial Administrators may be reached locally as listed below:

Province/Territory	CAMVAP Number
British Columbia & Yukon Territories	1 (800) 207-0685
Alberta & Northwest Territories	1 (800) 207-0685
Saskatchewan	1 (800) 207-0685
Manitoba	1 (800) 207-0685
Ontario	1 (800) 207-0685
Atlantic Canada	1 (800) 207-0685
Quebec	1 (800) 207-0685

▼ **Regional Offices**

REGIONAL OFFICES	AREAS COVERED
MAZDA CANADA INC. WESTERN REGION 8171 ACKROYD ROAD SUITE 2000 RICHMOND B.C. V6X 3K1 (604) 303-5670	ALBERTA, BRITISH COLUMBIA, MANITOBA, SASKATCHEWAN, YUKON
MAZDA CANADA INC. CENTRAL/ATLANTIC REGION 55 VOGELL ROAD, RICHMOND HILL, ONTARIO, L4B 3K5 (905) 787-7000	ONTARIO
MAZDA CANADA INC. QUEBEC REGION 6111 ROUTE TRANS CANADIENNE POINTE CLAIRE, QUEBEC H9R 5A5 (514) 694-6390	QUEBEC, NEW BRUNSWICK, NOVA SCOTIA, PRINCE EDWARD ISLAND, NEWFOUNDLAND

Customer Information and Reporting Safety Defects

## Customer Assistance

---

### Customer Assistance (Puerto Rico)

Your complete and permanent satisfaction is our business. That is why all Authorized Mazda Dealers have the knowledge and the tools to keep your Mazda vehicle in top condition.

If you have any questions or recommendations for improvement regarding the service of your Mazda vehicle or servicing by Mazda Dealer personnel, we recommend that you take the following steps:

#### ▼STEP 1

Discuss the matter with an Authorized Mazda Dealer. This is the quickest and best way to address the issue. If your concern has not been resolved by the CUSTOMER RELATIONS, SALES, SERVICE, or PARTS MANAGER, then please contact the GENERAL MANAGER of the dealership or the OWNER.

#### ▼STEP 2

If, after following STEP 1, you feel the need for further assistance, please contact your area's Mazda representative (Indicated on the next page).

Please help us by providing the following information:

1. Your name, address, and telephone number
2. Year and model of vehicle
3. Vehicle Identification Number (17 digits, noted on your registration or title or located on the upper driver's side corner of the dash)
4. Purchase date and current mileage
5. Your dealer's name and location
6. Your question(s)

## Customer Assistance

### Customer Assistance (Mexico)

Your complete and permanent satisfaction is our business. We are here to serve you. All Authorized Mazda Dealers have the knowledge and the tools to keep your Mazda vehicle in top condition.

If you have any questions or recommendations for improvement regarding the service of your Mazda vehicle or servicing by Mazda Dealer personnel, we recommend that you take the following steps:

#### ▼STEP 1: Contact Your Mazda Dealer

Discuss the matter with an Authorized Mazda Dealer. This is the quickest and best way to address the issue.

- If your concern has not been resolved by the CUSTOMER RELATIONS, SALES, SERVICE, or PARTS MANAGER, then please contact the GENERAL MANAGER of the dealership or the OWNER.
- If it becomes necessary to have the components or wiring system for the supplementary restraint system modified to accommodate a person with certain medical conditions in accordance with a certified physician, go to STEP2.

#### ▼STEP 2: Contact Mazda Motor de Mexico

If for any reason you feel the need for further assistance after contacting your dealership management and it becomes necessary to have the components or wiring system for the supplementary restraint system modified to accommodate a person with certain medical conditions in accordance with a certified physician, you can reach Mazda Motor de Mexico by one of the following ways.

Log on: at [www.MazdaMexico.com.mx](http://www.MazdaMexico.com.mx)

Answers to many questions, including how to locate or contact a local Mazda dealership in Mexico, can be found here.

E-mail: click on “Contactanos” at the top of the page at [www.MazdaMexico.com.mx](http://www.MazdaMexico.com.mx)

By phone at: 1 (866) 315 0220

By letter at:

Attn: Customer Assistance  
Mazda North American Operations  
7755 Irvine Center Drive  
Irvine, CA 92618-2922  
P.O. Box 19734  
Irvine, CA 92623-9734

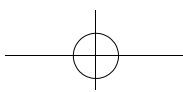

Customer Information and Reporting Safety Defects

## Customer Assistance

---

In order to serve you efficiently and effectively, please help us by providing the following information:

1. Your name, address, and telephone number
2. Year and model of vehicle
3. Vehicle Identification Number (17 digits, noted on your registration or title or located on the upper driver's side corner of the dash)
4. Purchase date and current mileage
5. Your dealer's name and location
6. Your question(s)

**9-10**

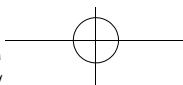

Customer Information and Reporting Safety Defects  
**Mazda Importer/Distributors**

**Importer/Distributor**

▼ **U.S.A.**

**Mazda North American Operations**

7755 Irvine Center Drive  
Irvine, CA 92618-2922 U.S.A.  
P.O. Box 19734  
Irvine, CA 92623-9734 U.S.A.  
TEL: 1 (800) 222-5500 (in U.S.A.)  
(949) 727-1990 (outside U.S.A.)

**Distributor in Each Area**

▼ **CANADA**

**Mazda Canada Inc.**

55 Vogell Road, Richmond Hill,  
Ontario, L4B 3K5 Canada  
TEL: 1 (800) 263-4680 (in Canada)  
(905) 787-7000 (outside Canada)

▼ **PUERTO RICO/U.S. Virgin Island**

**Plaza Motors Corp. (Mazda de Puerto Rico)**

P.O. Box 362722, San Juan, Puerto Rico  
00936-2722  
TEL: (787) 641-9300

▼ **MEXICO**

**Mazda Motor de Mexico**

Circuito Guillermo Gonzalez Camarena N  
1500 Col. Centro de Ciudad Santa Fe.  
01210, Mexico, D.F.  
TEL: Center of Attention to Clients:  
01 (800) 016 2932. in Mexico

▼ **GUAM**

**Triple J Motors**

157 South Marine Drive, Tamuning,  
GUAM 96911 USA  
P.O. Box 6066 Tamuning, Guam 96931  
TEL: (671) 649-6555

▼ **SAIPAN**

**Pacific International Marianas, Inc.  
(d.b.a. Midway Motors)**

P.O. Box 887 Saipan, MP 96950  
TEL: (670) 234-7524

Customer Information and Reporting Safety Defects

## **Mazda Importer/Distributors**

---

### **Triple J Saipan, Inc.**

**(d.b.a. Triple J Motors)**

P.O. Box 500487 Saipan, MP 96950-0487

TEL: (670) 234-7133/3051

### **▼ AMERICAN SAMOA**

#### **Polynesia Motors, Inc.**

P.O. Box 1120, Pago Pago, American

Samoa 96799

TEL: (684) 699-9347



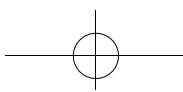

## Warranty

### Warranties for Your Mazda

- New Vehicle Limited Warranty
- Distributor Major Component Limited Warranty (Canada only)
- Safety Restraint System Limited Warranty
- Anti-perforation Limited Warranty
- Federal Emission Control Warranty (U.S.A. only)
  - Emission Defect Warranty
  - Emission Performance Warranty
- California Emission Control Warranty (U.S.A. only)
- Emission Control Warranty (Canada only)
- Replacement Parts and Accessories Limited Warranty
- Tire Warranty

**NOTE**

*Detailed warranty information is provided with your Mazda.*

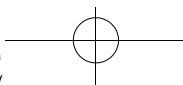

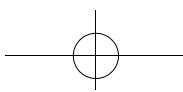

Customer Information and Reporting Safety Defects

## Warranty

---

### Outside the United States and Canada

Government regulations in the United States and Canada require that automobiles meet specific emission regulations and safety standards. Therefore, vehicles built for use in the United States, its territories, and Canada may differ from those sold in other countries.

The differences may make it difficult or even impossible for your vehicle to receive satisfactory servicing in other countries. We strongly recommend that you NOT take your Mazda outside these areas.

You may have these problems if you do:

- Recommended fuel may be unavailable. Any kind of leaded fuel or low-octane fuel will affect vehicle performance and damage the emission controls and engine.
- Proper repair facilities, tools, testing equipment, and replacement parts may not be available.

The Mazda warranty applies only to Mazda vehicles registered and normally operated in the United States, its territories, and Canada.

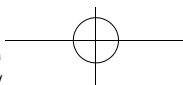

## Warranty

### Outside the United States

Government regulations in the United States require that automobiles meet specific emission regulations and safety standards. Therefore, vehicles built for use in the United States may differ from those sold in other countries.

The differences may make it difficult or even impossible for your vehicle to receive satisfactory servicing in other countries. We strongly recommend that you NOT take your Mazda outside the United States. However, in the event that you are moving to Canada permanently, Mazda vehicles built for use in the United States could be eligible for exportation to Canada with specific vehicle modifications to comply with the Canadian Motor Vehicle Safety requirements (CMVSS).

**NOTE**

*The above is applicable for a permanent import/export situation and not related to travelers on vacation.*

You may have the following problems if you do take your vehicle outside of the United States:

- Recommended fuel may be unavailable. Any kind of leaded fuel or low-octane fuel will affect vehicle performance and damage the emission controls and engine.
- Proper repair facilities, tools, testing equipment, and replacement parts may not be available.

Please refer to your Manufacturer's Warranty Booklet for more information.

Customer Information and Reporting Safety Defects

## Warranty

---

### Outside Canada

Government regulations in Canada require that automobiles meet specific emission regulations and safety regulations. Therefore, vehicles built for use in Canada may differ from those sold in other countries.

The differences may make it difficult or even impossible for your vehicle to receive satisfactory servicing in other countries. We strongly recommend that you NOT take your Mazda outside Canada. However, in the event that you are moving to the United States permanently, Mazda vehicles built for use in Canada could be eligible for exportation to the United States with specific vehicle modifications to comply with the United States Federal Motor Vehicle Safety Standards (FMVSS).

#### **NOTE**

*The above is applicable for a permanent import/export situation and not related to travelers on vacation.*

You may have the following problems if you do take your vehicle outside of Canada:

- Recommended fuel may be unavailable. Any kind of leaded fuel or low-octane fuel will affect vehicle performance and damage the emission controls and engine.
- Proper repair facilities, tools, testing equipment, and replacement parts may not be available.

Please refer to your Manufacturer's Warranty Booklet for more information.

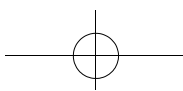

## **Registering Your Vehicle in A Foreign Country (Except United States and Canada)**

Government regulations in your country could require that automobiles meet specific emission and safety standards.

Vehicles built for your country may differ from those built for other countries. In addition to registration problems, satisfactory service may be difficult or even impossible in another country.

The fuel specified for your vehicle may be unavailable.

Parts, servicing techniques, and tools necessary to maintain and repair your vehicle may be unavailable.

There might not be an Authorized Mazda Dealer in the country you plan to take your vehicle.

The Mazda warranty is valid only in certain countries.

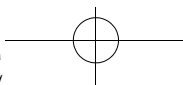
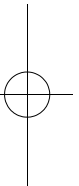
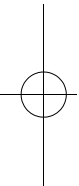

Customer Information and Reporting Safety Defects

## Warranty

### Add-On Non-Genuine Parts and Accessories

Non-genuine parts and accessories for Mazda vehicles can be found in stores. These may fit your vehicle, but they are not approved by Mazda for use with Mazda vehicles. When you install non-genuine parts or accessories, they could affect your vehicle's performance or safety systems; the Mazda warranty doesn't cover this. Before you install any non-genuine parts or accessories, consult an Authorized Mazda Dealer.

#### **WARNING**

***Always consult an Authorized Mazda Dealer before you install non-genuine parts or accessories:***

*Installation of non-genuine parts or accessories is dangerous. Improperly designed parts or accessories could seriously affect your vehicle's performance or safety systems. This could cause you to have an accident or increase your chances of injuries in an accident.*

***Be very careful in choosing and installing add-on electrical equipment, such as mobile telephones, two-way radios, stereo systems, and car alarm systems:***

*Incorrectly choosing or installing improper add-on equipment or choosing an improper installer is dangerous. Essential systems could be damaged, causing engine stalling, air-bag (SRS) activation, ABS inactivation, or a fire in the vehicle.*

Mazda assumes no responsibility for death, injury, or expenses that may result from the installation of add-on non-genuine parts or accessories.

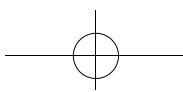

## Cell Phones

### Cell Phones Warning

#### **WARNING**

***Please comply with the legal regulations concerning the use of communication equipment in vehicles in your country:***

*Use of any electrical devices such as cell phones, computers, portable radios, vehicle navigation or other devices by the driver while the vehicle is moving is dangerous. Dialing a number on a cell phone while driving also ties-up the driver's hands. Use of these devices will cause the driver to be distracted and could lead to a serious accident. If a passenger is unable to use the device, pull off the right-of-way to a safe area before use. If use of a cell phone is necessary despite this warning, use a hands-free system to at least leave the hands free to drive the vehicle. Never use a cell phone or other electrical devices while the vehicle is moving and, instead, concentrate on the full-time job of driving.*

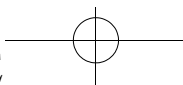

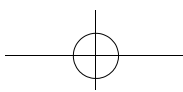

Customer Information and Reporting Safety Defects

## Type Approval of Equipment

### Type Approval of Equipment (Mexico)

#### Immobilizer system

Este equipo opera a título secundario, consecuentemente, debe aceptar interferencias perjudiciales incluyendo equipos de la misma clase y puede no causar interferencias a sistemas operando a título primario

Sistema inmovilizador  
Modelo : IMB111-02

#### Sistema inmovilizador con marcado de confirmación por radio

**COFETEL RCPMAIM05-614**

Sistema inmovilizador  
Modelo : IMB111-03

#### Sistema inmovilizador con marcado de confirmación por radio

**COFETEL RCPMAIM05-935**

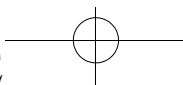



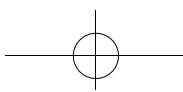

## Uniform Tire Quality Grading System (UTQGS)

### Uniform Tire Quality Grading System (UTQGS)

This information relates to the tire grading system developed by the U.S. National Highway Traffic Safety Administration for grading tires by tread wear, traction, and temperature performance.

#### ▼ Tread Wear

The tread wear grade is a comparative rating based on the wear rate of the tire when tested under controlled conditions on a specified government test course. For example, a tire graded 150 would wear one-and-a-half times as well on the government course as a tire graded 100.

The relative performance of tires depends upon the actual conditions of their use, however, and may depart significantly from the norm because of variations in driving habits, service practices and differences in road characteristics and climate.

#### ▼ Traction-AA, A, B, C

The traction grades, from highest to lowest, are AA, A, B, and C. These grades represent the tire's ability to stop on wet pavement as measured under controlled conditions on specified government test surfaces of asphalt and concrete. A tire marked C may have poor traction performance.

#### **⚠ WARNING**

*The traction grade assigned to this tire is based on braking (straight ahead) traction tests and does not include acceleration cornering (turning), hydroplaning, or peak traction characteristics.*

#### ▼ Temperature-A, B, C

The temperature grades A (the highest), B, and C, represent the tire's resistance to the generation of heat and its ability to dissipate heat when tested under controlled conditions on a specified indoor laboratory test wheel.

Sustained high temperature can cause the material of the tire to degenerate and reduce tire life, and excessive temperatures can lead to sudden tire failure.

Grade C corresponds to a level of performance which all passenger vehicle tires must meet under the Federal Motor Vehicle Safety Standard No. 109. Grades B and A represent higher levels of performance on the laboratory test wheel than the minimum required by law.

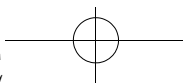

Customer Information and Reporting Safety Defects

## Uniform Tire Quality Grading System (UTQGS)

---

### **⚠ WARNING**

**Keep your vehicle's tires properly inflated and not overloaded:**

*Driving with improperly inflated or overloaded tires is dangerous. Excessive speed, underinflation, or excessive loading, either separately or in combination, can cause heat buildup and possible tire failure. The temperature grade for this tire is established for a tire that is properly inflated and not overloaded.*

These grades will be added to the sidewalls of passenger vehicle tires over the next several years according to a schedule established by the NHTSA and the tire manufacturers.

The grade of tires available as standard or optional equipment on Mazda vehicles may vary with respect to grade.

ALL PASSENGER VEHICLE TIRES MUST CONFORM TO THESE GRADES AND TO ALL OTHER FEDERAL TIRE-SAFETY REQUIREMENTS.

### ▼ Uniform Tire Quality Grading

Quality grades can be found where applicable on the tire sidewall between tread shoulder and maximum section width.

For example:

**Treadwear 200 Traction AA Temperature A**

UTQGS MARK (example)

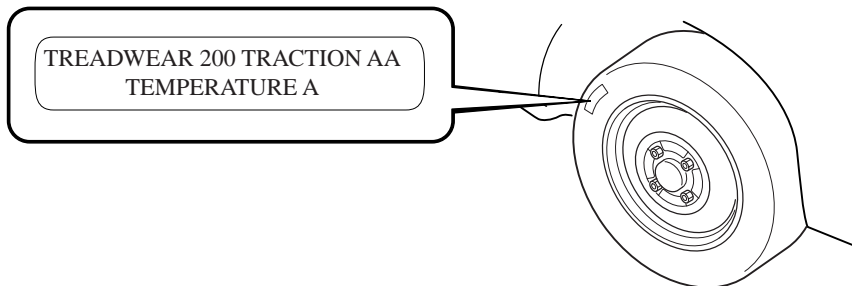

Customer Information and Reporting Safety Defects  
**Tire Information (except Canada)**

## Tire Labeling

Federal law requires tire manufacturers to place standardized information on the sidewall of all tires. This information identifies and describes the fundamental characteristics of the tire and also provides a tire identification number for safety standard certification and in case of a recall.

### ▼ Information on Passenger Vehicle Tires

Please refer to the diagram below.

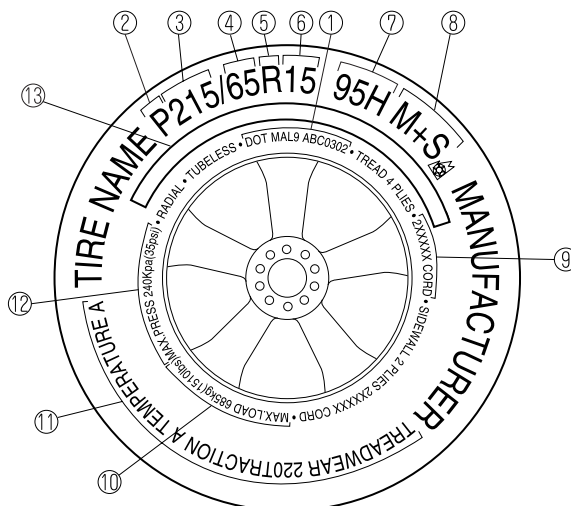

1. TIN: U.S. DOT tire identification number
2. Passenger car tire
3. Nominal width of tire in millimeters
4. Ratio of height to width (aspect ratio)
5. Radial
6. Rim diameter code
7. Load index & speed symbol
8. Severe snow conditions
9. Tire ply composition and materials used
10. Max. load rating

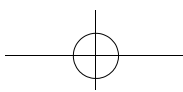

Customer Information and Reporting Safety Defects

## Tire Information (except Canada)

---

11. Tread wear, traction and temperature grades
12. Max. permissible inflation pressure
13. SAFETY WARNING

P215/65R15 95H is an example of a tire size and load index rating. Here is an explanation of the various components of that tire size and load index rating. Note that the tire size and load index rating may be different from the example.

### **P**

Indicates a tire that may be installed on cars, SUVs, minivans and light trucks as designated by the Tire and Rim Association (T&RA).

### ***NOTE***

*If your tire size does not begin with a letter this may mean it is designated by either ETRTO (European Tire and Rim Technical Organization) or JATMA (Japan Tire Manufacturing Association).*

### **215**

“215” is the nominal width of the tire in millimeters. This three-digit number gives the width in millimeters of the tire from sidewall edge to sidewall edge. In general, the larger the number, the wider the tire.

### **65**

“65” is the aspect ratio. This two-digit number indicates the tire's ratio of height to width.

### **R**

“R” is the tire construction symbol. R indicates “Radial ply construction”.

### **15**

“15” is the wheel rim diameter in inches.

### **95**

“95” is the Load Index. This two-or three-digit number indicates how much weight each tire can support.

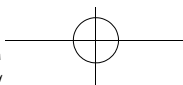

Customer Information and Reporting Safety Defects  
**Tire Information (except Canada)**

**H**

“H” is the speed rating. The speed rating denotes the maximum speed for which the use of the tire is rated.

Letter Rating	Speed Rating
Q	99 mph
R	106 mph
S	112 mph
T	118 mph
U	124 mph
H	130 mph
V	149 mph
W	168* mph
Y	186* mph

\* For tires with a maximum speed capability over 149 mph, tire manufacturers sometimes use the letters ZR. For tires with a maximum speed capability over 186 mph, tire manufacturers always use the letters ZR.

**M+S or M/S: Mud and Snow**

AT: All Terrain.

AS: All Season. The “M+S” or “M/S” indicates that the tire has some functional use in mud and snow.

**U.S. DOT Tire Identification Number (TIN)**

This begins with the letters “DOT” which indicates the tire meets all federal standards. The next two numbers or letters are the plant code where it was manufactured, and the last four numbers represent the week and year the tire was manufactured. For example, the numbers 457 means the 45st week of 1997. After 2000 the numbers go to four digits. For example, the number 2102 means the 21th week of 2002. The other numbers are marketing codes used at the manufacturer's discretion. This information is used to contact consumers if a tire defect requires a recall.

**Tire Ply Composition and Materials Used**

The number of plies indicates the number of layers of rubber-coated fabric in the tire. In general, the greater the number of plies, the more weight a tire can support. Tire manufacturers also must indicate the tire materials, which include steel, nylon, polyester, and other.

**Maximum Load Rating**

This number indicates the maximum load in kilograms and pounds that can be carried by the tire.

**Maximum Permissible Inflation Pressure**

This number is the greatest amount of air pressure that should ever be put in the tire under normal driving conditions.

Customer Information and Reporting Safety Defects

## **Tire Information (except Canada)**

---

### **Tread Wear, Traction and Temperature Grades**

**Tread wear:** The tread wear grade is a comparative rating based on the wear rate of the tire when tested under controlled conditions on a specified government test course. For example, a tire graded 150 would wear one and one-half (1 1/2) times as well on the government course as a tire graded 100.

**Traction:** The traction grades, from highest to lowest are AA, A, B, and C. The grades represent the tire's ability to stop on wet pavement as measured under controlled conditions on specified government test surfaces of asphalt and concrete. A tire marked C may have poor traction performance.

**Temperature:** The temperature grades are A (the highest), B and C, representing the tire's resistance to the generation of heat and its ability to dissipate heat when tested under controlled conditions on a specified indoor laboratory test wheel.

### **Snow Tires**

In some heavy snow areas, local governments may require true snow tires, those with very deeply cut tread. These tires should only be used in pairs or placed on all four wheels. Make sure you purchase snow tires that are the same size and construction type as the other tires on your vehicle.

### **SAFETY WARNING**

The following safety warning appears on the tire's sidewall.

SERIOUS INJURY MAY RESULT FROM:

- EXPLOSION OF TIRE/RIM ASSEMBLY DUE TO IMPROPER MOUNTING-MATCH TIRE DIAMETER TO RIM DIAMETER; NEVER EXCEED 40 psi (275 kPa) TO SEAT BEADS-ONLY SPECIALLY TRAINED PERSONS SHOULD MOUNT TIRES.
- TIRE FAILURE DUE TO UNDER-INFLATION/OVERLOADING/DAMAGE-FOLLOW OWNER'S MANUAL AND PLACARD IN VEHICLE-FREQUENTLY CHECK INFLATION PRESSURE AND INSPECT FOR DAMAGE.

Customer Information and Reporting Safety Defects  
**Tire Information (except Canada)**

▼ **Information on Temporary Tires**

Please refer to the diagram below.

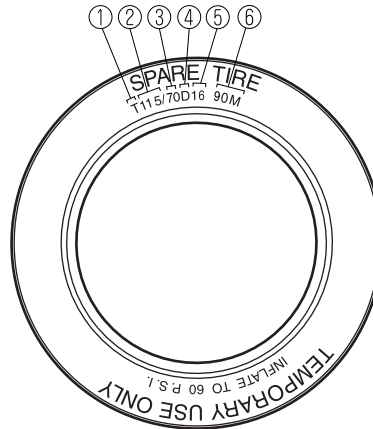

1. Temporary tires
2. Nominal width of tire in millimeters
3. Ratio of height to width (aspect ratio)
4. Diagonal
5. Rim diameter code
6. Load index&speed symbol

T115/70D 16 90M is an example of a tire size and load index rating. Here is an explanation of the various components of that tire size and load index rating. Note that the tire size and load index rating may be different from the example.

**T**

Indicates a tire that may be installed on cars, SUVs, minivans and light trucks as designated by the Tire and Rim Association (T&RA).

**115**

“115” is the nominal width of the tire in millimeters. This three-digit number gives the width in millimeters of the tire from sidewall edge to sidewall edge. In general, the larger the number, the wider the tire.

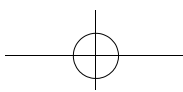

Customer Information and Reporting Safety Defects

## **Tire Information (except Canada)**

---

### **70**

“70” is the aspect ratio. This two-digit number indicates the tire's ratio of height to width.

### **D**

“D” is the tire construction symbol. D indicates “diagonal ply construction”.

### **16**

“16” is the wheel rim diameter in inches.

### **90**

“90” is the Load Index. This two-or three-digit number indicates how much weight each tire can support.

### **M**

“M” is the speed rating. The speed rating denotes the maximum speed for which the use of the tire is rated.

<b>Letter Rating</b>	<b>Speed Rating</b>
M	81 mph

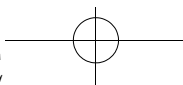



Customer Information and Reporting Safety Defects  
**Tire Information (except Canada)**

**Location of the Tire Label (Placard)**

You will find the tire label containing tire inflation pressure by tire size and other important information on the driver's side B-pillar or on the edge of the driver's door frame.

**SAMPLE**



TIRE AND LOADING INFORMATION

SEATING CAPACITY : TOTAL 5 : FRONT 2 : REAR 3

The combined weight of occupants and cargo should never exceed 385kg or 850 lbs.

TIRE	SIZE	COLD TIRE PRESSURE	SEE OWNER'S
FRONT	P235/60R 18	220KPA, 32PSI	MANUAL FOR ADDITIONAL INFORMATION
REAR	P235/60R 18	220KPA, 32PSI	
SPARE	T155/90D 18	420KPA, 60PSI	

**▼ Recommended Tire Inflation Pressure**

On the tire label you will find the recommended tire inflation pressure in both kPa and psi for the tires installed as original equipment on the vehicle. It is very important that the inflation pressure of the tires on your vehicle is maintained at the recommended pressure. You should check the tire pressure regularly to insure that the proper inflation pressure is maintained.

Refer to Tires on page 10-6.

**NOTE**

*Tire pressures listed on the vehicle placard or tire information label indicate the recommended cold tire inflation pressure, measured when the tires are cold, after the vehicle has been parked for at least 3 hours. As you drive, the temperature in the tire warms up, increasing the tire pressure.*

Customer Information and Reporting Safety Defects

## Tire Information (except Canada)

---

### **WARNING**

**Always check the tire inflation pressures on a regular basis according to the recommended tire inflation pressure on the tire label and in conjunction with the information in this owner's manual:**

*Driving your vehicle with under-inflated tires is dangerous.*

*Under-inflation is the most common cause of failures in any kind of tire and may result in severe cracking, tread separation or "blowout", with unexpected loss of vehicle control and increased risk of injury. Under-inflation increases sidewall flexing and rolling resistance, resulting in heat buildup and internal damage to the tire. It results in unnecessary tire stress, irregular wear, loss of control and accidents. A tire can lose up to half of its air pressure and not appear to be flat!*

*It is impossible to determine whether or not tires are properly inflated just by looking at them.*

### ▼ **Checking Tire Pressure**

1. When you check the air pressure, make sure the tires are cold —meaning they are not hot from driving even a mile.
2. Remove the cap from the valve on one tire.
3. Firmly press a tire gauge onto the valve.
4. Add air to achieve recommended air pressure.
5. If you overfill the tire, release air by pushing on the metal stem in the center of the valve. Then recheck the pressure with your tire gauge.
6. Replace the valve cap.
7. Repeat with each tire, including the spare.

#### **NOTE**

*Some spare tires require higher inflation pressure.*

8. Visually inspect the tires to make sure there are no nails or other objects embedded that could poke a hole in the tire and cause an air leak.
9. Check the sidewalls to make sure there are no gouges, cuts, bulges, cracks or other irregularities.

#### **NOTE**

*Warm tires normally exceed recommended pressures. Don't release air from warm tires to adjust the pressure.*

*Under-inflation can cause serious failures and accidents.*

*Over-inflation can produce a harsh ride and the greater possibility of damage from road hazards.*

**9-30**

## Tire Information (except Canada)

---

### ▼ Glossary of Terms

**Tire Placard:** A label indicating the OE tire sizes, recommended inflation pressure, and the maximum weight the vehicle can carry.

**Tire Identification Number (TIN):** A number on the sidewall of each tire providing information about the tire brand and manufacturing plant, tire size, and date of manufacture.

**Inflation Pressure:** A measure of the amount of air in a tire.

**kPa:** Kilopascal, the metric unit for air pressure.

**psi:** Pounds per square inch, the English unit for air pressure.

**B-pillar:** The structural member at the side of the vehicle behind the front door.

**Original Equipment (OE):** Describes components originally equipped on the vehicle.

**Vehicle Load Limit:** The maximum value of the combination weight of occupants and cargo.

**Bead Area of the Tire:** Area of the tire next to the rim.

**Sidewall Area of the Tire:** Area between the bead area and the tread.

**Tread Area of the Tire:** Area on the perimeter of the tire that contacts the road when it's mounted on the vehicle.

**Seating capacity** means the total allowable number of vehicle occupants. Seating capacity is described on the tire label.

**Production options weight** is the combination weight of installed regular production options weighing over 2.3 kilograms in excess of the standard items which they replace, and not previously considered in the curb weight or accessory weight, including heavy duty brakes, ride levelers, roof rack, heavy duty battery, and special trim.

**Rim** is the metal support (wheel) for a tire or a tire and tube assembly upon which the tire beads are seated.

Customer Information and Reporting Safety Defects

## Tire Information (except Canada)

### Tire Maintenance

Improper or inadequate vehicle maintenance can cause tires to wear abnormally. Here are some important maintenance points:

#### ▼ Tire Inflation Pressure

Inspect all tire pressure monthly (including the spare) when the tires are cold. Maintain recommended pressures for the best ride, top handling, and minimum tire wear. Use the pressures specified on the vehicle tire information placard or tire label for optimum service.

#### ▼ Tire Rotation

To equalize tread wear, rotate the tires every 12,000 km (7,500 miles) or sooner if irregular wear develops. During rotation, inspect them for correct balance.

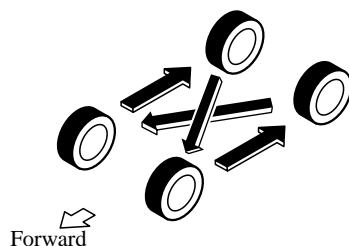

Do not include (TEMPORARY USE ONLY)  
spare tire in rotation.

Inspect the tires for uneven wear and damage. Abnormal wear is usually caused by one or a combination of the following:

- Incorrect tire pressure
- Improper wheel alignment
- Out-of-balance wheel
- Severe braking

After rotation, inflate all tire pressures to specification (page 10-6) and inspect the lug nuts for tightness.

Customer Information and Reporting Safety Defects  
**Tire Information (except Canada)**

**CAUTION**

Rotate unidirectional tires and radial tires that have an asymmetrical tread pattern or studs only from front to rear, not from side to side. Tire performance will be weakened if rotated from side to side.

**(With limited-slip differential)**

Don't use the following:

- Tires not of the designated size
- Tires of different sizes or types at the same time
- Tires not sufficiently inflated

If these instructions aren't followed, the rotation of the left and right wheels will be different and will thus apply a constant load on the limited-slip differential. This will cause a malfunction.

**▼ Replacing a Tire**

**WARNING**

**Always use tires that are in good condition:**

Driving with worn tires is dangerous. Reduced braking, steering, and traction could result in an accident.

If a tire wears evenly, a wear indicator will appear as a solid band across the tread. Replace the tire when this happens.

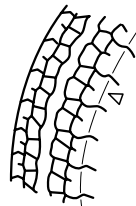

New tread

Tread wear indicator

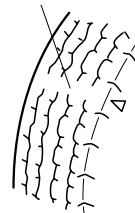

Worn tread

You should replace it before the band is across the entire tread.

**NOTE**

Tires degrade over time, even when they are not being used on the road. It is recommended that tires generally be replaced when they are 6 years or older. Heat caused by hot climates or frequent high loading conditions can accelerate the aging process. You should replace the spare tire when you replace the other road tires due to the aging of the spare tire. Regarding the manufacturing week and year is indicated with 4 digit. Refer to The tire labeling on page 9-23.

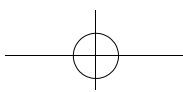

Customer Information and Reporting Safety Defects

## Tire Information (except Canada)

---

### ▼ Safety Practices

The way you drive has a great deal to do with your tire mileage and safety. So cultivate good driving habits for your own benefit.

- Observe posted speed limits
- Avoid fast starts, stops and turns
- Avoid potholes and objects on the road
- Do not run over curbs or hit the tire against the curb when parking

### **⚠ CAUTION**

*If you feel a sudden vibration or ride disturbance while driving or you suspect your tire or vehicle has been damaged, immediately reduce your speed. Drive with caution until you can safely pull off the road. Stop and inspect the tire for damage. If the tire is under-inflated or damaged, deflate it, remove the tire and rim and replace it with your spare tire. If you cannot detect a cause, have the vehicle towed to the nearest vehicle or tire dealer to have the vehicle inspected.*

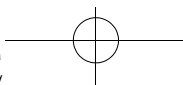

Customer Information and Reporting Safety Defects  
**Tire Information (except Canada)**

## Vehicle Loading

This section will guide you in the proper loading of your vehicle and/or trailer, to keep your loaded vehicle weight within its design rating capability, with or without a trailer. Properly loading your vehicle will provide maximum return of vehicle design performance. Before loading your vehicle, familiarize yourself with the following terms for determining your vehicle's weight ratings, with or without a trailer, from the vehicle's Safety Certification Label and Tire and Load Information Label:

### **! WARNING**

#### **Overloaded Vehicle:**

*Overloading a vehicle is dangerous. The results of overloading can have serious consequences in terms of passenger safety. Too much weight on a vehicle's suspension system can cause spring or shock absorber failure, brake failure, handling or steering problems, irregular tire wear, tire failure or other damage. Overloading makes a vehicle harder to drive and control. It also increases the distance required for stopping. In cases of serious overloading, brakes can fail completely, particularly on steep grades. The load a tire will carry safely is a combination of the size of the tire, its load range, and corresponding inflation pressure.*

*Never overload the vehicle and always observe the vehicle's weight ratings from the vehicle's Safety Certification and Tire and Load Information labels.*

**Base Curb Weight** is the weight of the vehicle including a full tank of fuel and all standard equipment. It does not include passengers, cargo, or optional equipment.

**Vehicle Curb Weight** is the weight of your new vehicle when you picked it up from your dealer plus any aftermarket equipment.

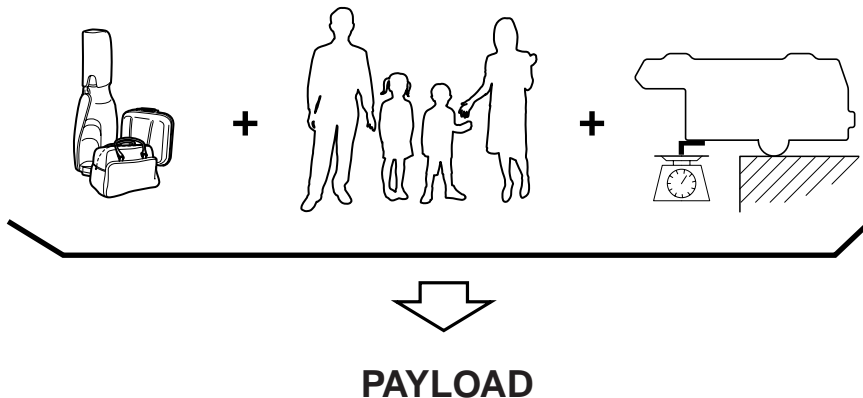

Customer Information and Reporting Safety Defects

**Tire Information (except Canada)**

**Payload** is the combination weight of cargo and passengers that the vehicle is designed to carry. The maximum payload for your vehicle can be found on the Tire and Load Information label on the driver's door frame or door pillar. Look for "THE COMBINATION WEIGHT OF OCCUPANTS AND CARGO SHOULD NEVER EXCEED XXX kg or XXX lbs" for your maximum payload. The payload listed on the tire label is the maximum payload for the vehicle as built by the assembly plant. If any aftermarket or dealer installed equipment has been installed on the vehicle, the weight of the equipment must be subtracted from the payload listed on the tire label in order to be accurate.

**SAMPLE**



## TIRE AND LOADING INFORMATION

SEATING CAPACITY : TOTAL 5 : FRONT 2 : REAR 3

The combined weight of occupants and cargo should never exceed 385kg or 850 lbs.

TIRE	SIZE	COLD TIRE PRESSURE	SEE OWNER'S
FRONT	P235/60R 18	220KPA, 32PSI	MANUAL FOR
REAR	P235/60R 18	220KPA, 32PSI	ADDITIONAL
SPARE	T155/90D 18	420KPA, 60PSI	INFORMATION

(XXX)



Customer Information and Reporting Safety Defects  
**Tire Information (except Canada)**

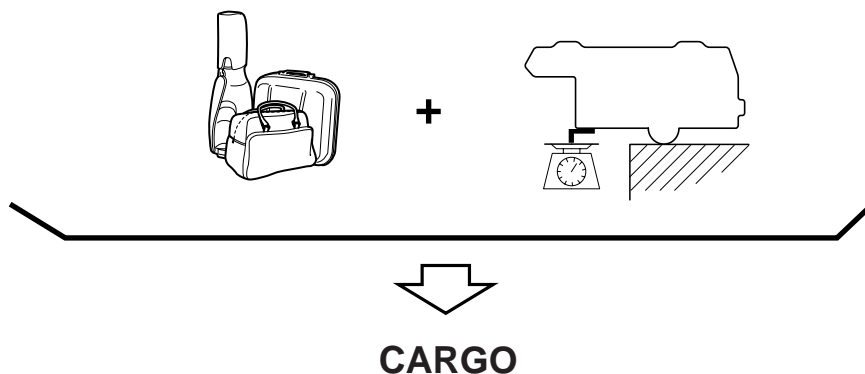

**Cargo Weight** includes all weight added to the Base Curb Weight, including cargo and optional equipment. When towing, trailer tongue load or king pin weight is also part of cargo weight.

The cargo weight limit decreases depending on the number of vehicle occupants. The cargo weight limit can be calculated by subtracting the total weight of the vehicle occupants from the “combination weight of occupants and cargo should never exceed” value on the tire label.

Examples: Based on a single occupant weight of 68 kg (150 lbs), and a value of 385 kg (849 lbs) for the “combination weight of occupants and cargo should never exceed”:  
The cargo weight limit with one occupant is  $385 \text{ kg (849 lbs)} - 68 \text{ kg (150 lbs)} = 317 \text{ kg (699 lbs)}$

The cargo weight limit with two occupants is  $385 \text{ kg (849 lbs)} - (68 \times 2) \text{ kg (} (150 \times 2) \text{ lbs)} = 249 \text{ kg (549 lbs)}$

If the weight of the occupant increases, the cargo weight limit decreases by that much.

**GAW (Gross Axle Weight)** is the total weight placed on each axle (front and rear) - including vehicle curb weight and all payload.

Customer Information and Reporting Safety Defects

## Tire Information (except Canada)

**GAWR (Gross Axle Weight Rating)** is the maximum allowable weight that can be carried by a single axle (front or rear). **These numbers are shown on the Safety Compliance Certification Label located on the driver's door frame or door pillar. The total load on each axle must never exceed its GAWR.**

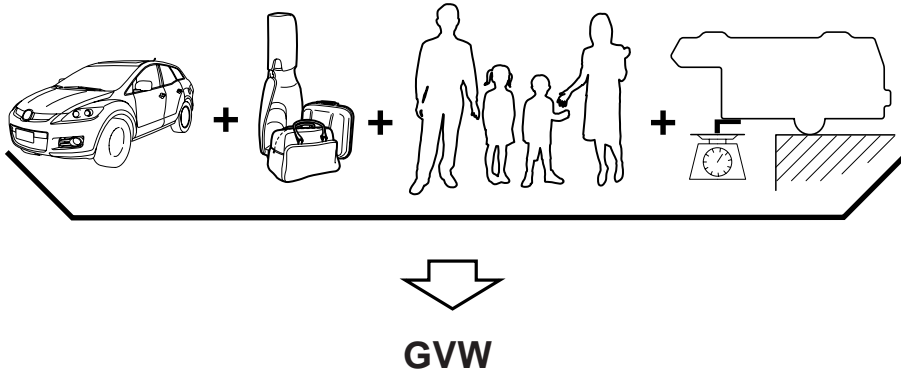

**GVW (Gross Vehicle Weight)** is the Vehicle Curb Weight + cargo + passengers.

**GVWR (Gross Vehicle Weight Rating)** is the maximum allowable weight of the fully loaded vehicle (including all options, equipment, passengers and cargo). **The GVWR is shown on the Safety Compliance Certification Label located on the driver's door frame or door pillar. The GVW must never exceed the GVWR.**



Customer Information and Reporting Safety Defects

## Tire Information (except Canada)

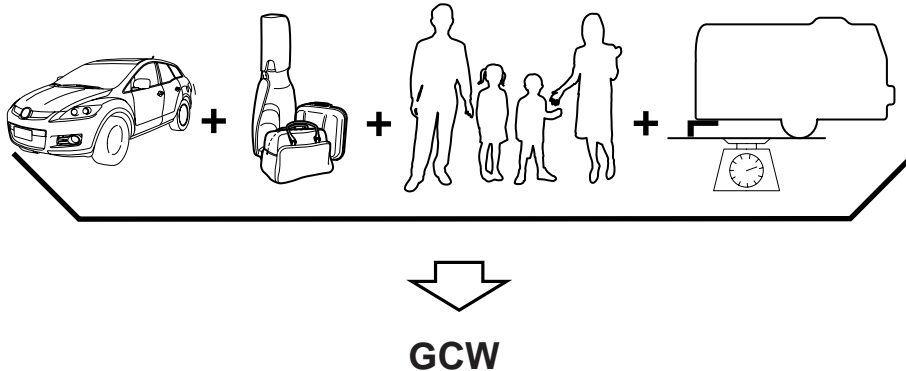

**GCW (Gross Combination Weight)** is the weight of the loaded vehicle (GVW) plus the weight of the fully loaded trailer.

**GCWR (Gross Combination Weight Rating)** is the maximum allowable weight of the vehicle and the loaded trailer - including all cargo and passengers - that the vehicle can handle without risking damage. (Important: The towing vehicle's braking system is rated for operation at GVWR, not at GCWR. Separate functional brakes should be used for safe control of towed vehicles and for trailers weighing more than 1,500 lbs). **The GCW must never exceed the GCWR.**

**Maximum Loaded Trailer Weight** is the highest possible weight of a fully loaded trailer the vehicle can tow. It assumes a vehicle with only mandatory options, no cargo (internal or external), a tongue load of 10–15% (conventional trailer) or king pin weight of 15–25% (fifth-wheel trailer), and driver only (150 lbs). **Consult your dealership (or the RV and Trailer Towing Guide provided by your dealership) for more detailed information.** **Tongue Load or Fifth-Wheel King Pin Weight** refers to the amount of the weight that a trailer pushes down on a trailer hitch.

**Examples:** For a 5000 lb conventional trailer, multiply 5000 by 0.10 and 0.15 to obtain a proper tongue load range of 500 to 750 lbs. For an 11,500 lb fifth-wheel trailer, multiply by 0.15 and 0.25 to obtain a proper king pin load range of 1,725 to 2,875 lbs.

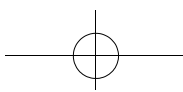

Customer Information and Reporting Safety Defects

## Tire Information (except Canada)

---

### **WARNING**

**Exceeding GVWR or GAWR Specifications:**

*Exceeding the GVWR or the GAWR specified on the certification label is dangerous. Exceeding any vehicle rating limitation could result in a serious accident, injury, or damage to the vehicle.*

*Do not use replacement tires with lower load carrying capacities than the originals because they may lower the vehicle's GVWR and GAWR limitations. Replacement tires with a higher limit than the originals do not increase the GVWR and GAWR limitations.*

*Never exceed the GVWR or the GAWR specified on the certification label.*

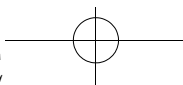
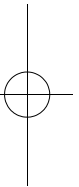
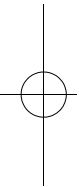

Customer Information and Reporting Safety Defects

## Tire Information (except Canada)

---

### Steps for Determining the Correct Load Limit:

Steps for Determining Correct Load Limit:

- (1) Locate the statement “The combined weight of occupants and cargo should never exceed XXX kg or XXX lbs” on your vehicle's placard.
- (2) Determine the combined weight of the driver and passengers that will be riding in your vehicle.
- (3) Subtract the combined weight of the driver and passengers from XXX kg or XXX lbs.
- (4) The resulting figure equals the available amount of cargo and luggage load capacity. For example, if the “XXX” amount equals 1400 lbs. and there will be five 150 lb passengers in your vehicle, the amount of available cargo and luggage load capacity is 650 lbs.  $(1400 - 750 (5 \times 150) = 650$  lbs.)
- (5) Determine the combined weight of luggage and cargo being loaded on the vehicle. That weight may not safely exceed the available cargo and luggage load capacity calculated in Step 4.
- (6) If your vehicle will be towing a trailer, the load from your trailer will be transferred to your vehicle. Consult this manual to determine how this reduces the available cargo and luggage load capacity of your vehicle.

## Reporting Safety Defects

### Reporting Safety Defects (U.S.A.)

If you believe that your vehicle has a defect which could cause a crash or could cause injury or death, you should immediately inform the National Highway Traffic Safety Administration (NHTSA) in addition to notifying Mazda Motor Corporation (Your Mazda Importer/Distributor).

If NHTSA receives similar complaints, it may open an investigation, and if it finds that a safety defect exists in a group of vehicles, it may order a recall and remedy campaign. However, NHTSA cannot become involved in individual problems between you, your dealer, or Mazda Motor Corporation (Your Mazda Importer/Distributor).

To contact NHTSA, you may call the Vehicle Safety Hotline toll-free at 1-888-327-4236 (TTY: 1-800-424-9153) ; go to <http://www.safercar.gov>; or write to: Administrator, NHTSA, 400 Seventh Street, SW., Washington, DC 20590. You can also obtain other information about motor vehicle safety from <http://www.safercar.gov>.

**NOTE**

*If you live in the U.S.A., all correspondence to Mazda Motor Corporation should be forwarded to:*

*Mazda North American Operations  
7755 Irvine Center Drive  
Irvine, California 92618-2922  
P.O. Box 19734  
Irvine, CA 92623-9734  
Customer Assistance Center or toll free at 1 (800) 222-5500*

*If you live outside of the U.S.A., please contact the nearest Mazda Distributor shown (page 9-11) in this booklet.*

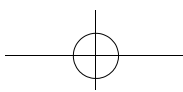

Customer Information and Reporting Safety Defects

## Reporting Safety Defects

---

### Reporting Safety Defects (Canada)

Canadian customers who wish to report a safety-related defect to Transport Canada, Defect Investigations and Recalls, may telephone the toll free hotline 1-800-333-0510, or contact Transport Canada by mail at: Transport Canada, ASFAD, Place de Ville Tower C, 330 Sparks Street, Ottawa ON K1A 0N5.

For additional road safety information, please visit the Road Safety website at:  
<http://www.tc.gc.ca/roadsafety/menu.htm>

9-44

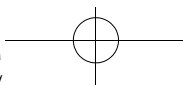



## Service Publications

### Service Publications

Factory-authorized Mazda service publications are available for owners who wish to do some of their own maintenance and repair.

When requesting any of our publications through an Authorized Mazda Dealer, refer to the chart below.

If they don't have what you need in stock, they can order it for you.

PUBLICATION ORDER NUMBER	PUBLICATION DESCRIPTION
9999-95-034B-08	2008 WORKSHOP MANUAL (English)
9999-MX-034B-08	2008 WORKSHOP MANUAL (Spanish)
9999-95-068G-08	2008 WIRING DIAGRAM (English)
9999-MX-068G-08	2008 WIRING DIAGRAM (Spanish)
9999-95-080C-08 (U.S.A. only)	2008 OWNER'S MANUAL
9999-EC-080C-08 (Canada only)	2008 OWNER'S MANUAL
9999-PR-080C-08 (Puerto Rico, Mexico only)	2008 OWNER'S MANUAL
9999-95-MODL-08	2008 SERVICE HIGHLIGHTS
9999-95-011C-08NAV (U.S.A. only)	2008 NAVIGATION SYSTEM OWNER'S MANUAL
9999-EC-011C-08NAV (Canada only)	2008 NAVIGATION SYSTEM OWNER'S MANUAL

#### ▼ WORKSHOP MANUAL:

Covers recommended maintenance and repair procedures of the drive train, body and chassis.

#### ▼ WIRING DIAGRAM:

Provides electrical schematics as well as component location for the entire electrical system.

#### ▼ OWNER'S MANUAL:

This booklet contains information regarding the proper care and operation of your vehicle. This is not a technician's manual.

#### ▼ SERVICE HIGHLIGHTS:

Provides description and operation of the many systems of your Mazda.

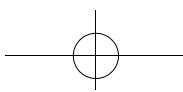

Customer Information and Reporting Safety Defects

## Service Publications

---

### ▼ NAVIGATION SYSTEM OWNER'S MANUAL:

This booklet contains information regarding the proper operation and use of the navigation system. This is not a technician's manual.

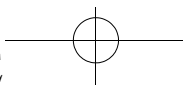

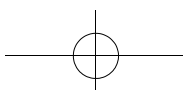

# 10 Specifications

Technical information about your Mazda.

<b>Identification Numbers .....</b>	<b>10-2</b>
Vehicle Information Labels .....	10-2
<b>Specifications .....</b>	<b>10-4</b>
Specifications .....	10-4

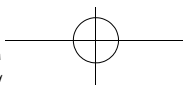

## Identification Numbers

### Vehicle Information Labels

#### ▼ Vehicle Identification Number

The vehicle identification number legally identifies your vehicle. The number is on a plate attached to the cowl panel located on the left corner of the dashboard. This plate can easily be seen through the windshield.

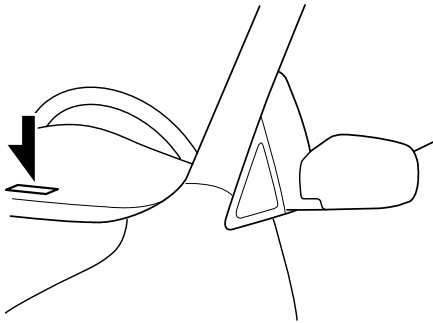

#### ▼ Motor Vehicle Safety Standard Label

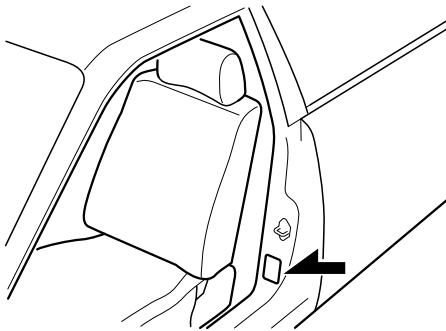

#### ▼ Chassis Number

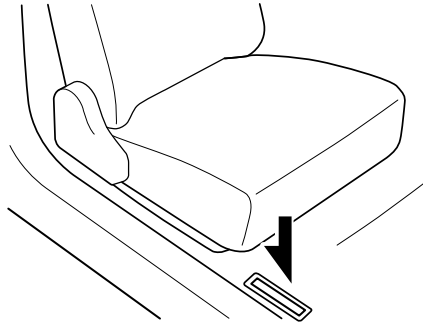

#### ▼ Vehicle Emission Control Information Label

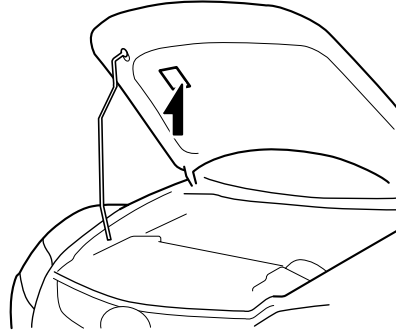

#### ▼ Tire Pressure Label (Except Canada)

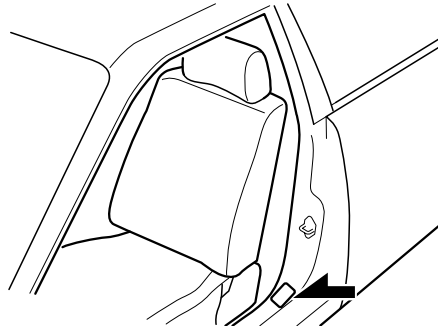

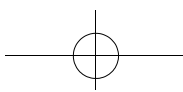

## Identification Numbers

---

### ▼ Engine Number

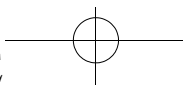
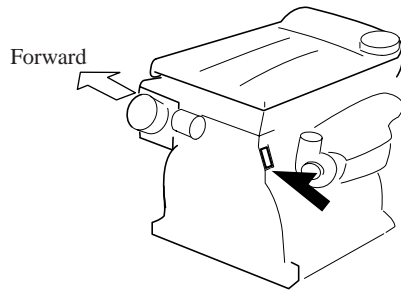

## Specifications

### Specifications

#### ▼ Engine

Item	Specification
Type	DOHC-16V in-line, 4-cylinder
Bore×Stroke	87.5 × 94.0 mm (3.44 × 3.70 in)
Displacement	2,261 ml (2,261 cc, 137.9 cu in)
Compression ratio	9.5

#### ▼ Electrical System

Item	Classification
Battery	12V-48AH/5HR MF
	12V-55AH/5HR MF
Spark-plug number	L3K9 18 110A <sup>*1</sup>
	L3Y3 18 110
Spark-plug gap	0.70—0.80 mm (0.028—0.031 in)

\*1 ex factory

#### **⚠ CAUTION**

*When cleaning the iridium plugs, do not use a wire brush. The fine particulate coating on the iridium alloy and platinum tips could be damaged.*

#### ▼ Lubricant Quality

Lubricant	Classification
Engine oil	Refer to the recommended SAE viscosity numbers on page 8-19.
Automatic transaxle fluid	JWS3309
Transfer case oil	API Service GL-5 (SAE 80W-90)
Rear differential oil	API Service GL-5 (SAE 80W-90)
Power steering fluid	ATF M-III, M-V, or equivalent (e.g. Dexron® II)
Brake fluid	SAE J1703, or FMVSS116 DOT-3

## Specifications

### ▼ Capacities

#### (Approximate Quantities)

Item		Capacity
Engine oil	With oil filter replacement	5.7 L (6.0 US qt, 5.0 Imp qt)
	Without oil filter replacement	5.3 L (5.6 US qt, 4.7 Imp qt)
Coolant		9.0 L (9.5 US qt, 7.9 Imp qt)
Automatic transaxle fluid		7.0 L (7.4 US qt, 6.2 Imp qt)
Transfer case oil		1.2 L (1.3 US qt, 1.1 Imp qt)
Rear differential oil		1.0 L (1.1 US qt, 0.9 Imp qt)
Washer fluid	With low washer fluid level warning light	4.5 L (4.8 US qt, 4.0 Imp qt)
	Without low washer fluid level warning light	2.5 L (2.6 US qt, 2.2 Imp qt)
Fuel tank		69.0 L (18.2 US gal, 15.2 Imp gal)

Check oil and fluid levels with dipsticks or reservoir gauges.

### ▼ Dimensions

Item		Vehicle specification
Overall length	With license plate holder	4,680 mm (184.3 in)
	Without license plate holder	4,675 mm (184.1 in)
Overall width		1,872 mm (73.7 in)
Overall height		1,645 mm (64.8 in)
Front tread		1,617 mm (63.7 in)
Rear tread		1,612 mm (63.5 in)
Wheelbase		2,750 mm (108.3 in)

### ▼ Weights

Item	Weight	
	2WD	AWD
GVWR (Gross Vehicle Weight Rating)	2,168 kg (4,780 lbs)	2,267 kg (4,998 lbs)
GAWR (Gross Axle Weight Rating)	Front	1,150 kg (2,535 lbs)
	Rear	1,022 kg (2,253 lbs)

### ▼ Air Conditioner

Item	Classification
Refrigerant Type	HFC134a (R-134a)

## Specifications

### ▼ Light Bulbs

#### Exterior light

Light bulb			Category	
			Wattage	ECE R (SAE)
Headlights	High beam		60	HB3 (#9005)
	Low beam	Halogen	55	H7 (H7)
		Xenon fusion	35	D2S (—)
Front turn signal lights/Parking lights			27/8	— (#1157NA)
Front side-marker lights			5	W5W (#168)
Fog lights *			55	H11 (H11)
High-mount brake light * <sup>1</sup>			2.4	— (—)
Rear turn signal lights			21	WY21W (—)
Brake lights/Taillights			21/5	W21/5W (#7743)
Reverse lights			21	W21W (#7440)
License plate lights			5	W5W (#168)
Rear side-marker lights			5	W5W (#168)

\*1 Bulb replacement is not possible because it is built into the unit. Replace the unit.

#### Interior light

Light bulb	Category	
	Wattage	ECE R
Overhead lights/Map lights (Front)	5	W5W
Overhead light (Rear)	10	—
Luggage compartment light	10	—

### ▼ Tires

#### **NOTE**

*The tires have been optimally matched with the chassis of your vehicle.*

*When replacing tires, Mazda recommends that you replace tires of the same type originally fitted to your vehicle. For details, contact an Authorized Mazda Dealer.*

Check the tire pressure label for tire size and inflation pressure.

Refer to Tire Inflation Pressure on page 8-34.

#### **Standard tire**

(Except Mexico)

Tire size	Inflation pressure	
	Front	Rear
P235/60R18 102H	220 kPa (32 psi)	220 kPa (32 psi)

**10-6** \*Some models.



## Specifications

(Mexico)

Tire size	Inflation pressure	
	Front	Rear
235/60R18 103H	230 kPa (34 psi)	230 kPa (34 psi)

### Temporary spare tire

(Except Mexico)

Tire size	Inflation pressure
T155/90D18 103M	420 kPa (60 psi)

(Mexico)

Tire size	Inflation pressure
205/80R16 100M	250 kPa (36 psi)

### ▼ Fuses

Refer to the fuse rating on page 8-45.

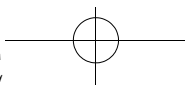
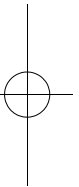
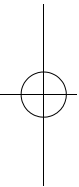
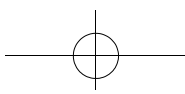

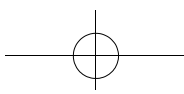

---

**11** **Index**

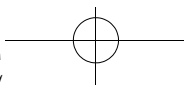
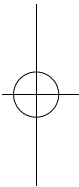
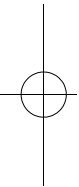

## Index

### A

- Accessory Socket ..... 6-54
- Add-On Non-Genuine Parts and Accessories ..... 9-18
- Advanced Key ..... 3-2
  - Advanced key maintenance ..... 3-5
  - Advanced key suspend function ..... 3-15
  - Service ..... 3-6
  - Warning and Beep Sounds ..... 3-16
- Air Bag Systems ..... 2-47
- All-Wheel Drive (AWD) Operation ..... 5-16
  - AWD Warning light ..... 5-17
- Ambient Temperature Display ..... 6-50
- Antenna ..... 6-15
- Anti-Lock Brake System (ABS) ..... 5-7
  - Warning light ..... 5-7
- Appearance Care ..... 8-50
- Audio System ..... 6-15
  - Audio control switch ..... 6-42
  - Audio set ..... 6-25
  - Operating tips for audio system ..... 6-15
  - Safety certification ..... 6-45
- Automatic Transaxle
  - Driving tips ..... 5-15
  - Fluid ..... 8-25
  - Manual shift mode ..... 5-12
  - Shift-lock system ..... 5-12
  - Transaxle ranges ..... 5-11

### B

- Battery
  - Emergency starting ..... 7-13
  - Maintenance ..... 8-32
  - Specifications ..... 10-4

### B

- Beeps
  - Ignition key reminder ..... 5-52
  - Lights-on reminder ..... 5-52
  - Parking brake reminder ..... 5-52
  - Seat belt warning beep Sounds ... 5-52
  - Tire inflation pressure warning beep ..... 5-52
- Before Starting the Engine ..... 4-5
  - After getting in ..... 4-5
  - Before getting in ..... 4-5
- Body Lubrication ..... 8-28
- Bottle Holder ..... 6-52
- Brake
  - Fluid ..... 8-23
- Brakes
  - Anti-lock brake system (ABS) ..... 5-7
  - Brakes assist ..... 5-8
  - Foot brake ..... 5-5
  - Pad wear indicator ..... 5-9
  - Parking brake ..... 5-5
  - Warning light ..... 5-6
- Break-In Period ..... 4-6
- Bulb Replacement ..... 8-39

### C

- Capacities ..... 10-5
- Carbon Monoxide ..... 4-4
- Cargo Securing Loops ..... 6-53
- Catalytic Converter ..... 4-3
- Cell Phones ..... 9-19
- Center Console ..... 6-53
- Child Restraint
  - Child restraint precautions ..... 2-28
  - Installing child-restraint systems ..... 2-32
  - LATCH child-restraint systems ..... 2-41

## Index

### C

Child Safety Locks for Rear Doors ...	3-27
Climate Control System .....	6-2
Gas specifications .....	10-5
Clock .....	6-50
Cruise Control .....	5-19
Cup Holder .....	6-51
Customer Assistance .....	9-2

### D

Dashboard Illumination .....	5-36
Daytime Running Lights .....	5-55
Defroster	
Rear window .....	5-59
Dimensions .....	10-5
Door Locks .....	3-24
Driving In Flooded Area .....	4-10
Driving Tips .....	4-6
Automatic transaxle .....	5-15
Break-in period .....	4-6
Driving in flooded area .....	4-10
Hazardous driving .....	4-7
Money-saving suggestions .....	4-6
Rocking the vehicle .....	4-8
Turbocharged vehicles .....	4-11
Winter driving .....	4-8
Dynamic Stability Control (DSC) ....	5-25
TCS/DSC Indicator light .....	5-26

### E

Emergency Starting .....	7-13
Flooded engine .....	7-13
Jump-starting .....	7-14
Push-starting .....	7-17
Emergency Towing .....	7-18
Emission Control System .....	4-3

### E

Engine	
Coolant .....	8-21
Exhaust gas .....	4-4
Hood release .....	3-39
Oil .....	8-19
Overheating .....	7-11
Starting .....	5-4
Engine Compartment Overview .....	8-18
Engine Coolant	
Overheating .....	7-11
Engine Coolant Temperature	
Gauge .....	5-35
Exhaust Gas .....	4-4
Exterior Care .....	8-52

### F

Flasher	
Hazard warning .....	5-60
Headlights .....	5-53
Flat Tire .....	7-3
Changing .....	7-6
Spare tire and tool storage .....	7-3
Fluids	
Classification .....	10-4
Owner maintenance .....	8-16
Fog Lights .....	5-56
Front .....	5-56
Foot Brake .....	5-5
Front Seats	
(Electrically Operated Seats) .....	2-5
Front Seats	
(Manually Operated Seats) .....	2-2
Fuel	
Filler lid and cap .....	3-38
Gauge .....	5-36
Requirements .....	4-2
Tank capacity .....	10-5

## Index

---

### F

- Fuses ..... 8-45
  - Panel description ..... 8-47
  - Replacement ..... 8-45

### G

- Glove Box ..... 6-53

### H

- Hazard Warning Flasher ..... 5-60
- Hazardous Driving ..... 4-7
- Headlights
  - Control ..... 5-53
  - Flashing ..... 5-55
  - High-low beam ..... 5-55
  - Leveling ..... 5-55
  - On reminder ..... 5-54
- Hood Release ..... 3-39
- Horn ..... 5-60

### I

- Ignition
  - Keys ..... 3-20
  - Switch ..... 5-2
- Illuminated Entry System ..... 6-47
- Immobilizer System
  - (with Advanced Key) ..... 3-46
  - Immobilizer System
    - (without Advanced Key) ..... 3-48

### I

- Indicator Lights ..... 5-38
  - Cruise ..... 5-51
  - Headlight high-beam ..... 5-49
  - Security ..... 5-49
  - Shift position ..... 5-49
  - TCS OFF ..... 5-50
  - TCS/DSC ..... 5-50
  - Turn-signal/hazard warning ..... 5-51
- Information Display ..... 6-49
  - Ambient temperature display ..... 6-50
  - Audio display ..... 6-51
  - Climate control display ..... 6-51
  - Clock ..... 6-50
  - Information display functions ..... 6-49
- Instrument Cluster ..... 5-33
- Interior Care ..... 8-55
- Interior Lights ..... 6-47

### J

- Jump-Starting ..... 7-14

### K

- Keyless Entry System ..... 3-21
- Keys ..... 3-20

### L

- Label Information ..... 10-2
- Lane-Change Signals ..... 5-56
- Liftgate ..... 3-28
  - Luggage compartment ..... 3-29
- Light Bulbs
  - Replacement ..... 8-39
  - Specifications ..... 10-6
- Lighting Control ..... 5-53
- Lubricant Quality ..... 10-4

## Index

### L

Luggage Compartment Light ..... 6-48

### M

#### Maintenance

Introduction ..... 8-2

Owner maintenance

precautions ..... 8-17

Owner maintenance schedule .... 8-16

Scheduled ..... 8-3

Map Lights ..... 6-48

#### Mirrors

Outside mirrors ..... 3-54

Rearview mirror ..... 3-55

Money-Saving Suggestions ..... 4-6

Moonroof ..... 3-40

### O

Odometer and Trip Meter ..... 5-34

Outside Mirrors ..... 3-54

Overhead Lights ..... 6-47

Overheating ..... 7-11

Overloading ..... 4-10

### P

Paint Damage ..... 8-50

Parking Brake ..... 5-5

Parking in an Emergency ..... 7-2

Power Door Locks ..... 3-26

Power Steering ..... 5-16

Fluid ..... 8-24

Power Windows ..... 3-31

Push-Starting ..... 7-17

### R

Rear Door Child Safety Locks ..... 3-27

Rear Seat ..... 2-9

Rear Window Defroster ..... 5-59

Rear Window Washer ..... 5-58

Rear Window Wiper ..... 5-58

Rearview Mirror ..... 3-55

Recreational Towing ..... 7-21

Registering Your Vehicle in A Foreign

Country ..... 9-17

Rocking the Vehicle ..... 4-8

### S

Safety Defects, Reporting ..... 9-43

#### Seat Belt System

Automatic locking ..... 2-16

Belt minder ..... 2-26

Center-rear position ..... 2-22

Emergency locking ..... 2-15

Except center-rear position ..... 2-17

Extender ..... 2-24

Pregnant women ..... 2-15

Pretensioner and load limiting .... 2-19

Seat belt precautions ..... 2-13

Warning light/beep ..... 2-26

#### Seats

Front seat

(Electrically operated seats) ..... 2-5

Front seat

(Manually operated seats) ..... 2-2

Rear seat ..... 2-9

Seat warmer ..... 2-4, 2-8

#### Security System

Immobilizer system

(without advanced key) ..... 3-48

Immobilizer system

(with advanced key) ..... 3-46

Theft-deterrent system ..... 3-51

## Index

---

### S

Service Publications .....	9-45
Side Extension Sunvisors .....	6-46
Spare Tire and Tool Storage .....	7-3
Specifications .....	10-4
Speedometer .....	5-34
Starting the Engine .....	5-4
Steering Wheel .....	3-54
Horn .....	5-60
Storage Compartments .....	6-53
Cargo securing loops .....	6-53
Center console .....	6-53
Glove box .....	6-53
Sunshade .....	3-45
Sunvisors .....	6-46

### T

Tachometer .....	5-35
Temporary Spare Tire .....	8-37
Theft-Deterrent System .....	3-51
Tiedown	
Hook .....	7-19
Tire Information .....	9-23
Tire Pressure Monitoring System .....	5-27
System error activation .....	5-31
Tire pressure monitoring system warning light .....	5-29
Tires and wheels .....	5-31
Tires	
Flat Tire .....	7-3
Inflation pressure .....	8-34
Replacement .....	8-36
Rotation .....	8-35
Snow tires .....	4-8
Spare tire and tool storage .....	7-3
Specifications .....	10-6
Uniform tire quality grading system (UTQGS) .....	9-21

### T

Tool .....	7-3
Towing	
Description .....	7-18
Emergency towing .....	7-18
Recreational towing .....	7-21
Trailer towing .....	4-12
Traction Control System (TCS) .....	5-22
TCS OFF indicator light .....	5-23
TCS OFF switch .....	5-24
TCS/DSC indicator light .....	5-23
Trailer Towing .....	4-12
Trip Meter .....	5-34
Turn and Lane-Change Signals .....	5-56

### V

Vanity Mirrors .....	6-46
Vehicle Information Labels .....	10-2



## Index

### W

Warning Lights .....	5-38
ABS .....	5-40
Air bag system .....	5-42
Automatic transaxle .....	5-45
AWD .....	5-45
Brake system .....	5-40
Charging system .....	5-41
Check engine .....	5-42
Door-ajar .....	5-44
Engine oil pressure .....	5-41
Front seat belt pretensioner system .....	5-42
KEY Warning Light (Red)/KEY Indicator Light (Green) .....	5-47
Low fuel .....	5-43
Low washer fluid level .....	5-44
Seat belt .....	5-43
Tire pressure monitoring system .....	5-45
Warranty .....	9-13
Washer Fluid .....	8-27
Weights .....	10-5
Wheel Replacement .....	8-37
Windows	
Power windows .....	3-31
Windshield Washer .....	5-58
Windshield Wipers .....	5-57
Blades replacement .....	8-28
Winter Driving .....	4-8

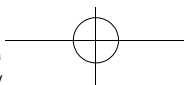
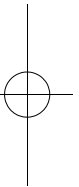
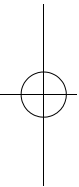
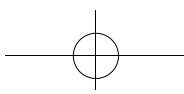

# NAVIGATION SYSTEM

<b>Preparation</b> See page 4 for specific information.	<b>Before Use</b>
<b>Immediate use</b> See page 4 for specific information.	<b>Getting started</b>
	<b>Routing</b>
<b>Advanced use</b> See page 5 for specific information.	<b>Address Book</b>
	<b>Voice Recognition</b>
	<b>Volume Adjustment</b>
<b>If necessary</b> See page 5 for specific information.	<b>If necessary</b>
<b>Audio System</b> See page 61 for specific information.	<b>Audio System</b>
<b>Rear View Monitor</b> See page 85 for specific information.	<b>Rear View Monitor</b>
<b>Bluetooth Hands-Free</b> See page 91 for specific information.	<b>Bluetooth Hands-Free</b>

## Accessories

Please contact an Authorized Mazda Dealer if you are missing the following accessory.



1 Map Disc

**CAUTION:**  
**THIS PRODUCT IS A CLASS I LASER PRODUCT. HOWEVER THIS PRODUCT USES A VISIBLE/ INVISIBLE LASER BEAM WHICH COULD CAUSE HAZARDOUS RADIATION EXPOSURE IF DIRECTED. BE SURE TO OPERATE THIS PRODUCT CORRECTLY AS INSTRUCTED. USE OF CONTROLS OR ADJUSTMENTS OR PERFORMANCE OF PROCEDURES OTHER THAN THOSE SPECIFIED HEREIN MAY RESULT IN HAZARDOUS RADIATION EXPOSURE. DO NOT OPEN COVERS AND DO NOT REPAIR YOURSELF. REFER SERVICING TO QUALIFIED PERSONNEL.**

**Laser products:**

Wavelength: 650 nm

Laser power: No hazardous radiation is emitted with safety protection.

# MEMO



Before Use

# Contents

---

## Preparation

n Before Use	
Accessories .....	2
Laser products: .....	2
Contents .....	4
Safety Information .....	6
Introduction .....	8
(Product Use Safety), (Navigation System), (Beep sound and voice guidance restrictions while using Bluetooth Hands-Free (Mazda CX-9 only)), (Screens)	
Names and Functions .....	9

---

## Immediate use

n Getting started	
Activation.....	12
(Removing the Map Disc), (On-screen Buttons)	
Set Clock.....	14
Navigation Set Up .....	15
(Language), (Calibration), (User Setting), (Quick POI Selection), (Restore System Defaults), (Map Configuration)	
Screen Names and Functions.....	25
(Screens Before Setting Route), (Screens During Route Guidance), (Menu), (Screen adjustments, beep alert and other settings)	
Screen change .....	29
(Changing the Map Orientation/Scale)	
n Routing	
Destination Entry and Route Search.....	30
(Change (Change Search Area)), (Address), (Point of interest), (Emergency), (Memory Point), (Home), (Preset Destination), (Previous Destination), (Intersection), (Freeway On/Off Ramp), (Coordinates), (Select from map)	
Quick POI.....	38
(Displaying POI(s) on a Map), (Local Search), (Deleting POI Markers), (Showing POI Data)	
Character Entry.....	39
(Street name, city name, and other input), (House phone number, and other input)	
Direct Destination Input.....	40
(Direct Destination Input), (Selecting Route)	
POI Icons on Maps / Delete Destination .....	41
(POI (Point of Interest) Icons), (Delete destination)	
Route Options .....	42
(Route Preferences), (Modification of Destination or Way Point Positions), (Deletion of Destination or Way Points), (Detour), (Turn List), (Display Preview), (Route Preview)	

---

---

## Advanced use

n	Address Book	
l	Address Book .....	46
	(Memory Point Storage), (Memory Point Confirmation and Modification), (Preset Destinations or Home Storage), (Memory Point Deletion), (All Memory Point Deletion), (Displays Icons at Memory Points), (Avoid Area Storage), (Avoid Area Confirmation and Modification), (Avoid Area Deletion), (All Avoid Area Deletion), (Category Name Modification), (Previous Destination Deletion), (All Preset Destination Deletion)	
n	Voice Recognition	
l	Voice Recognition .....	50
	(Voice Recognition Structure), (Language Select), (Basic Usage Pattern), (Cancel Voice Recognition), (Voice Recognition Command)	
n	Volume Adjustment	
l	Volume Adjustment .....	52

---

## If necessary

n	If necessary	
l	Precautions/System Performance .....	53
	(Voice Guidance), (GPS), (Map Matching), (Positioning Accuracy), (Route Guide), (Route Search)	
l	Troubleshooting .....	57
	(Verification First), (Error Messages)	
l	Maintenance .....	60
	(Care of the Product), (Handling and Care of Map Discs)	

---

# Safety Information

- n Read this owner's manual for your Navigation System carefully before using the system. It contains instructions about how to use the system in a safe and effective manner. Mazda assumes no responsibility for any problems resulting from failure to observe the instructions given in this manual.
- n This manual uses pictographs to show you how to use the product safely and to alert you to potential dangers resulting from improper connections and operation. The meanings of the pictographs are explained below. It is important that you fully understand the pictographs and explanations in order to use this manual and the system properly.



## Warning

The presence of this Warning symbol in the text is intended to alert you to the importance of heeding the operation instructions. Failure to heed the instructions may result in severe injury or death.



- n **Do not keep your eyes fixed on the monitor screen or operate the system while driving.**  
Do not change the settings and destination locations while driving. Minimize the time spent on viewing the monitor screen and listening to the voice guidance while driving. Operating the system will distract the driver from looking ahead of the vehicle and can cause accidents. Always stop the vehicle in a safe location and use the parking brake before operating the system.
- n **Always obey local traffic regulations.**  
Your guided route may include roads that are not open to vehicles or are closed due to traffic regulations. Comply with the local traffic regulations and take another route.
- n **Do not use the unit when it is out of order.**  
If the unit is out of order (no image, no sound) or in an abnormal state (has foreign matter in it, is exposed to water, is smoking, or smells), then turn it off immediately and consult with an authorized dealer, we recommend an Authorized Mazda Dealer. Using the unit in an out-of-order condition may lead to accidents, fires, or electric shocks.
- n **Use the proper power supply.**  
This product is designed for operation with a negative grounded 12 V DC battery system.
- n **Do not disassemble.**  
Do not disassemble the product or attempt to repair it yourself. If the product needs to be repaired, take it to an authorized dealer, we recommend an Authorized Mazda Dealer.





Caution

## Caution

The presence of this Caution symbol in the text is intended to alert you to the importance of heeding the operation instructions. Failure to heed the instructions may result in injury or material damage.



Cautions

- n **Do not use the product where it is exposed to water, moisture, or dust.**  
Exposure to water, moisture, or dust may lead to smoke, fire, or other damage to the unit. Make especially sure that the unit does not get wet in car washes or on rainy days.
- n **Keep the voice guidance volume at an appropriate level.**  
Keep the volume level low enough to be aware of road and traffic conditions while driving.
- n **Protect the Deck Mechanism.**  
Do not insert any foreign objects into the slot of this unit.
- n **This navigation system is designed exclusively for use in automobiles.**  
This navigation system should only be installed in an automobile. Do not install it in a ship, aircraft, or any other vehicles except an automobile. Do not use it detached from the vehicle.
- n **Do not insert or allow your hand or fingers to be caught in the unit.**  
To prevent injury, do not get your hand or fingers caught in moving parts or in the disc slot. Especially watch out for infants.

Operation is subject to the following two conditions;

- (1) this device may not cause interference, and
- (2) this device must accept any interference, including interference that may cause undesired operation of the device.

# Introduction

## Product Use Safety

### **n Extremely low or high temperatures may interfere with normal operation**

The inside of the vehicle can become very hot or cold when it is parked for extended periods in direct sunlight or in cold places with the engine turned off. The navigation system may not operate normally under such circumstances. Turn off the navigation system until the inside of the vehicle has cooled down or warmed up. If the system does not operate thereafter, consult an authorized dealer, we recommend an Authorized Mazda Dealer.

## Navigation System

This navigation system utilizes GPS\* satellite signals, a speed sensor and gyrosensor to track and display your vehicle's current position, and to guide you from your starting point to your destination along a calculated route.

\* : GPS (Global Positioning System) is a position detecting system utilizing the signals from GPS satellites deployed by the U.S. Defense Department.

## **Beep sound and voice guidance restrictions while using Bluetooth Hands-Free (Mazda CX-9 only)**

The beep sound and voice guidance related to the navigation system operation are not heard while a Bluetooth Hands-Free is being used.

## Screens

Screens displayed in this manual may differ from those on the actual display.

# Names and Functions

The navigation system can be operated by pressing a button on the panel (panel button) or selecting a button displayed on the screen (on-screen button).

## Mazda CX-9

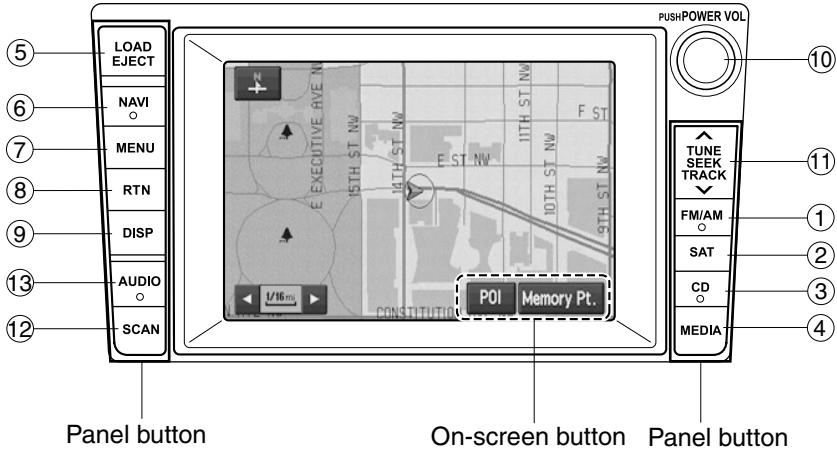

## Mazda CX-7

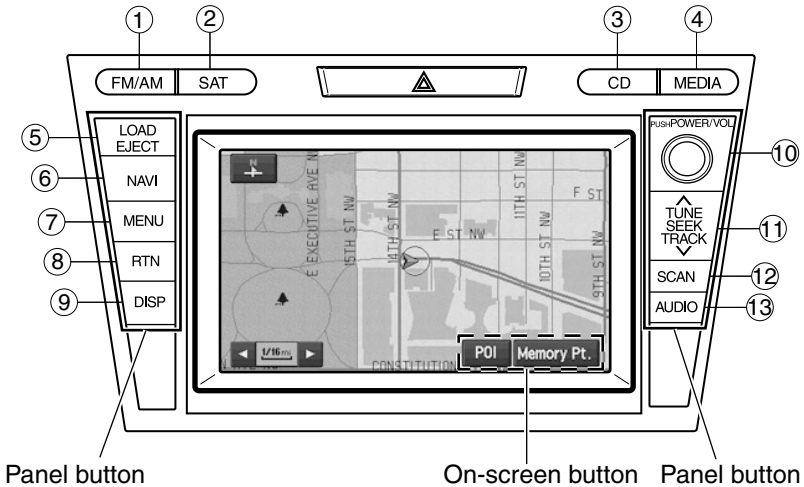

1. FM/AM button: FM/AM broadcast reception. Each time the button is pressed, the reception mode switches through three reception modes: FM 1 → FM 2 → AM.
  2. SAT button: SIRIUS digital satellite radio reception.
  3. CD button: CD playback.
  4. MEDIA button: Image and Sound playback is possible using a portable video player connected to an external input terminal.<sup>\*1</sup>  
Sound playback is possible using an audio player connected to an external input terminal.<sup>\*1</sup>  
AUX1: External sound  
AUX2: External image
  5. LOAD/EJECT button: CD loading and ejection.  
If the display is left in the lowered position for a certain period of time, a beep sound is heard and the display closes automatically.
  6. NAVI button<sup>\*2</sup>: Display of the navigation screen and the vehicle's present location.
  7. MENU button<sup>\*2</sup>: Menu screen display (various settings).
  8. RTN button<sup>\*2</sup>: Button used to return to the previous screen.
  9. DISP button: Screen brightness/contrast mode selection and adjustment display.
  10. POWER/VOLUME button: The volume can be adjusted by turning the dial. Turn the audio unit off by pressing the dial.
  11. TUNE/SEEK button: Performs tuning (short press) and searching (long press) in FM/AM mode. Performs track skip (short press) and fast-forward/reverse (long press) in CD mode.
  12. SCAN button: Performs scanning operation in FM/AM and CD modes.
  13. AUDIO button: Audio unit-related operation screen display (preset display of FM and AM).  
The on-screen touch button "SOUND" is constantly displayed at the bottom of the audio unit-related screen for displaying the sound quality adjustment screen when selected.
- <sup>\*1</sup>: The external input terminal is not equipped on your vehicle because it is not standard equipment.  
<sup>\*2</sup>: For navigation unit operation

### Note

- | If there is no response after selecting the on-screen button, remove your finger from the screen and select it again.
- | On-screen buttons that cannot be operated are not illuminated.



Select the on-screen button lightly with your finger.  
Selecting the on-screen buttons using objects that have a hard or sharp end such as a ball point pen or mechanical pencil could cause a malfunction.

# MEMO



Before Use

# Activation

Insert the map disc into the unit to start the Mobile Navigation System.



## n Map Disc

- Refer to “Handling and Care of Map Discs” to know how to handle a map disc (page 60).

## Note

- The map disc cannot be inserted or ejected while the ignition switch is in the OFF position.
- Remember that the battery can run down if the ignition switch is kept in the ACC or ON position for a long time while the engine not running.

## 1 Remove the cover. (Mazda CX-9 only)

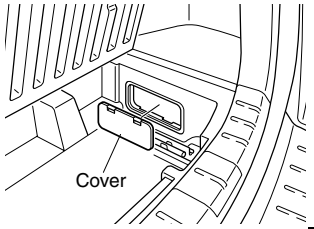

## 2 Insert the map disc with the printed side facing up.



## Note

- The main unit is located on the right side of the cargo sub-compartment under the trunk board. (Mazda CX-9)  
The main unit is located under the front passenger seat. (Mazda CX-7)
- Condensation may form on the optical lens or the map disc inside the unit when the temperature in the vehicle increases in a short time such as when heating the car on a cold day. This condensation may cause malfunctions. If so, unload the map disc and do not operate the unit for approximately 1 hour. Wipe the condensation off the map disc with a soft cloth.  
If the unit does not operate correctly after 1 hour, consult an Authorized Mazda Dealer.

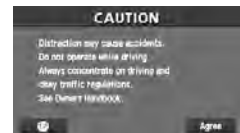

(CAUTION) screen

## Note

- When the ignition switch is in the ACC or ON position, the screen changes as follows to activate the navigation system.
- The screen (audio or navigation) that was displayed prior to the engine being turned off is displayed. Before the navigation screen is displayed, the CAUTION screen will be displayed.

### 3 Read the **CAUTION** carefully, and select the **Agree** on-screen button.



The Current Position screen appears.

#### Note

- You can select the language by selecting the **Language** on-screen button. You can also change the selected language using Language Selection. (page 22)
- The **CAUTION** screen remains on the display unless you select the **Agree** on-screen button.

(Mazda CX-9)

If the mobile telephone is programmed to the hands-free unit for use with the Bluetooth hands-free telephone, the Bluetooth hands-free information is displayed on the screen momentarily. While this information is displayed, the **Agree** on-screen button cannot be selected. Select the **Agree** on-screen button after the display is cleared.



Caution

Most functions are inhibited while the vehicle is in motion. Please read the handbook for operation instructions. Always obey traffic regulations.

## Removing the Map Disc

### 1 With the ignition switch in the ACC position, remove the cover.

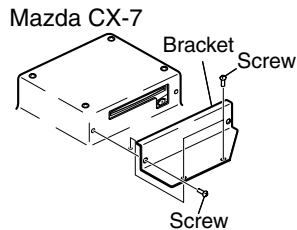
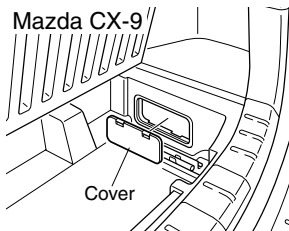

### 2 Press **▲ (EJECT)**.

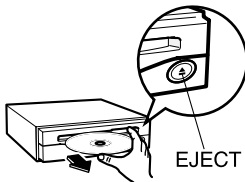

Caution

Do not get your hand or fingers caught in moving parts or in the disc slot. This can cause injuries. Children are inquisitive, try to install or remove the map disc without infants looking on.

## On-screen Buttons

Select the on-screen button lightly with your finger. Colors for unavailable buttons will be pale.

# Set Clock

The current time is set using this function. Since time notification is provided by a GPS satellite.

Before Steps

**MENU**



select Set Clock

Open the [SET CLOCK] screen



Select if you prefer 24-hour display; for 12-hour display.

Select to move the setting ahead by one hour, and similarly, select to move it back by one hour.

How to exit .

## Note

Minutes and seconds are adjusted by the GPS, however, it is necessary to adjust hours under the following conditions:

- | Driving across different time zones
- | Daylight saving time start and end



# Navigation Set Up

You can alter the map display conditions, the route guidance conditions and show the system information.



Warning

## n Stop your vehicle before the following operations.

Do not change the settings and destination locations while driving. Minimize the time spent viewing the monitor screen and listening to the voice guidance while driving. Operating the system will distract the driver from looking ahead of the vehicle and may cause an accident. Always stop the vehicle in a safe location and put the parking brake on before operating the system.

Before Steps

**MENU**









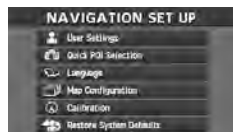



→ select

 Navigation Set Up

Open

**[NAVIGATION SET UP]**



-  User Settings (  page 20)
-  Quick POI Selection (  page 22)
-  Language (  page 16)
-  Map Configuration (  page 24)
-  Calibration (  page 18)
-  Restore System Defaults (  page 23)

# Navigation Set Up

Language

You can change the language of the menu and the voice guidance.

**MENU** → select  Navigation Set Up

---

**Before Steps**

→ select  Language

## Open the [LANGUAGE] screen



Select your preferred language from the list.

# MEMO

Getting started

This function allows you to correct any error in the position or direction of your vehicle display.

Before Steps **MENU** → select  Navigation Set Up

### Adjusting Current Position and Direction



select **Position / Direction**

Open the [Calibrate Position] screen



Move  to the correct position and select **OK**.



Use  or  to adjust the direction in which you are heading, and select **OK**.

### Distance

This function automatically corrects any error in the display of the current position that might occur after tire replacement.

select **Distance**

You will have to drive about 6 miles (10 km) before distance correction is complete.

select  Calibration

## Map Version

The map and software version numbers can be confirmed using this function.

select  Map Version

Map and software versions are now displayed.



# Navigation Set Up

## User Setting

**MENU** → select  Navigation Set Up

Before Steps

→ select  User Settings

Getting started

Open the [USERSETTINGS] screen



### Map Color



Select a screen color from **1** to **3** options.

### Map Mode



**Auto** : The display will automatically switch between Day and Night illumination mode when the headlights are turned off and on respectively.

**Day** : The display will be presented in Day illumination mode regardless of whether the headlights are on or off.

**Night** : The display will be presented in Night illumination mode regardless of whether the headlights are on or off.

### Distance



Select the distance unit from **km** or **Miles**.



### Average Speed



Set the average speed for each road to be driven.

(This function sets the standard speed (average vehicle speed for each route) used for calculating the estimated arrival time when calculating the route time.)



  Average speed setting

 :Changes back to default

### Road Restriction Warnings



The display of warnings during route guidance when passing through areas with traffic restrictions can be turned on or off.

**MENU** → select  Navigation Set Up

Before Steps

→ select  User Settings



### Open the [USER SETTINGS] screen



#### Arrival Time





The time which is displayed until reaching the destination or a way point can be set as an estimated arrival time or the remaining time.

Select  to display the estimated arrival time, or  to display the remaining time.

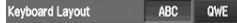
#### Keyboard Layout



The layout of input keys can be selected as  or .

#### Clock



Allows selection of whether clock is to be displayed. When the time display setting is switched on in the "USER SETTINGS" screen on the navigation screen, the time will be displayed on the navigation, SETTINGS, SOUND, LOAD/EJECT, and DISPLAY MODE screens. Even if the display of the clock on the navigation is not set, the clock on the information display remains displayed.

#### Beep



Allows selection of whether beep will sound.

# Navigation Set Up

## Quick POI Selection

This function allows you set the categories on the area displayed when the (Point of Interest) menu is selected on the map. Quick POI enables you store up to six different kinds of categories which you use most regularly.

1 **MENU** → select  Navigation Set Up

2 Select  Quick POI Selection

Getting started

### Open the [QUICK POI SELECTION] screen

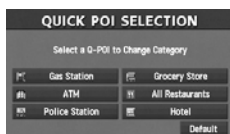

Select the button for Quick POI storage.

#### Note

Select the category to be changed

**Default** : This button allows you to restore the factory settings.

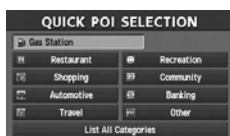

Select a category.

Once selected, subcategories will be displayed.

**List All Categories** : Subcategories from all of the individual categories will be displayed together.



Select the subcategories to be displayed on the map.

Repeat the above steps to add further POI markers displayed on the menu.



# Navigation Set Up

Restore System Defaults

This function replaces all the settings in the mobile navigation system with the initial default settings.

**Before Steps**

MENU → select  Navigation Set Up

→ select  Restore System Defaults



Getting started

**Open the [SYSTEM DEFAULTS] screen**

Select  .

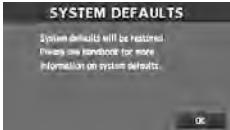

If you execute Restore System Defaults, all of your stored setting data will be deleted.

## [Default List]

Item	Initial condition
<b>Menu names</b>	
Map Orientation	North up
Map display mode	Single-screen display
Map Display scale/Map scale for Dual-screen is not object of backup.	Single-screen: 10,000 map (1/16 mi)
Display guidance language	English
Quick-POI map display	All Off
Quick-POI Selection	A : Gas station B : ATM C : Police Station D : Grocery store E : All Restaurant F : Hotel
Search Area	US9 (including Washington DC)
Map Color	1
Day/Night/Auto Setting	Auto
Distance Units (Miles/KM) (Global setting)	Miles
Volume Presets	4
Time display change (12h/24h)	24h
Keyboard layout	ABC
Arrival Time	Time
Navigation Setup (Clock)	Off
Navigation Setup (Beep)	On
<b>Map Configuration</b>	
Freeway Information	Off
Junction Detail	ON
Map screen	Single
Turn Guidance Screen	Turn List

**MENU** → select  Navigation Set Up

Before Steps  
→ select  Map Configuration

Getting started

## Open the [MAP CONFIGURATION] screen

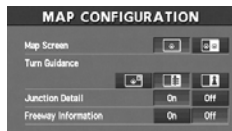

### Map Screen



Select single or dual map display.

### Single map



### Dual map



### Turn Guidance



### Turn Arrow (on first screen)



While using route guidance, the directions for the next junction where you have to turn are shown as a Turn Arrow in the upper right.

### Turn List



While using route guidance, the directions for the next junction where you have to turn are shown as Turn List.

### Turn Arrow (on second screen)

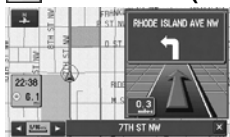

While using route guidance, the directions for the next junction where you have to turn are shown as Turn Arrow.

### Note

Before a fork in the road, an enlarged diagram of the junction automatically appears in a second screen. This is to make route guidance even clearer.

### Junction Detail



Select whether the Enlarged Junction diagram screen is displayed automatically.

### Freeway Information



Allows selection of whether the guidance screen is to be displayed while driving on a freeway.

# Screen Names and Functions

## Screens Before Setting Route

Getting started

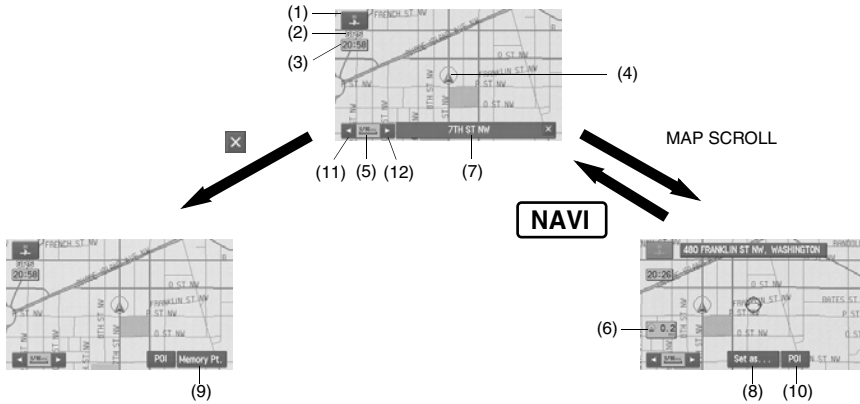

- (1) **Map Orientation control**  
(☞ page 29)
- (2) **GPS (Global Positioning System) marker**  
(☞ page 54)
- (3) **Clock**  
Clock will be displayed when you set up Clock on Navigation Set Up On.
- (4) **Vehicle marker**  
Shows the current position and direction of your vehicle.
- (5) **Scale display**  
Displays the scale of the map.
- (6) **Distance from current position**  
Displays the distance from the current position to the position pointed by ○.
- (7) **Current Road Name**  
Shows the name of the road you are currently driving on.
- (8) **Set Destination button**  
The destination, memory point or way point will be set at the position pointed by ○ in the scroll screen.
- (9) **Store Memory Point button**  
Stores markers on the map.
- (10) **Quick POI Display button**  
(☞ page 38)
- (11) **Zoom in**  
(☞ page 29)
- (12) **Zoom out**  
(☞ page 29)

## Screens During Route Guidance

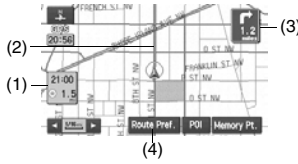

- (1) **Distance and Time to Destination display**  
Displays the time\* and distance to the destination or way point. Selecting this will display the next and further information on the way point or time and distance to the destination. (\* Either required time or estimated time arrival)
- (2) **Route display**  
Shows the provided route as a thick blue line.
- (3) **Turn Arrow display**  
Shows the direction to turn at the next junction and the distance to the junction.
- (4) **Route Preferences button**  
( page 42)

## Menu

Menu appears when pressing **MENU**.



- Destination Entry and Route Search ( page 30)
- Address Book ( page 46)
- Cancel Guidance ( page 41)
- Route Options ( page 42)
- Volume ( page 52)
- Set Clock ( page 14)



- Navigation Set Up ( page 15)

## Screen adjustments, beep alert and other settings

Display menu screen will be shown when you press the (DISP) button.  
Press the (DISP) button to display the display menu.



### n Adjusting the screen quality

#### l Screen brightness

Press the **+** on-screen button to brighten the screen, or **-** to darken.

#### l Screen contrast

Press the **+** on-screen button to increase contrast, **-** to decrease.

### Note

- l Select the **RESET** on-screen button to restore the adjustment values to the default settings.
- l The screen changes to SETTINGS when the **SETTINGS** on-screen button is selected.

### n Turning off the display

Select the **DISPLAY OFF** on-screen button to turn off the display.

The screen will reappear if the (NAVI) button is pressed, or the **DISPLAY ON** on-screen button, which is displayed on the screen when the (DISP) button is pressed, is selected.

### n Daytime/Night screen

When the headlights are on, daytime mode can also be selected (Daytime mode can also be selected while the headlights are turned on.).

### n Tilt display operation

Select the **↖** on-screen button to tilt the display, **↗** to close it.

The display angle can be adjusted in three stages.

When opening, the display angle changes one stage at a time each time the **↖** on-screen button is pressed.

When closing, the display angle changes one stage at a time each time the **↗** on-screen button is pressed.

Press the (DISP) button followed by the **SETTINGS** on-screen button to display the settings menu.



### n **Returning to the navigation screen from the audio unit screen**

- | Select the **MANUAL** on-screen button to set the function to return to the navigation screen from the audio unit screen by operation of the button only.
- | Select the **AUTO** on-screen button to set the function to return to the navigation screen from the audio unit screen automatically after 20 seconds.

### n **Beep sound settings**

- | Select the **ON** on-screen button to activate the operation beep sound.
- | Select the **OFF** on-screen button to deactivate the operation beep sound.



# Screen change Changing the Map Orientation/Scale



**Warning** Do not keep your eyes fixed on the monitor screen or operate the system while driving

Do not change the settings and destination locations while driving. Minimize the time spent viewing the monitor screen and listening to the voice guidance while driving. Operating the system will distract the driver from looking ahead of the vehicle and may cause an accident. Always stop the vehicle in a safe location and use the parking brake before operating the system.

## Map orientation

**1** Select ,  on-screen button.



**North Up:** Geographic north is up.





**Head Up:** The direction you are heading is up.



## Map scale



**1** Select  or  on-screen button.

The map can be displayed in 13 steps with scales from  to .



**ZOOM OUT**

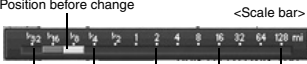

**ZOOM IN**  
(more detail.)



Position before change <Scale bar>



	1/32 mi	1/16 mi	1/8 mi	1/4 mi	1/2 mi	1 mi	2 mi	4 mi	8 mi	16 mi	32 mi	64 mi	128 mi
Imperial display	1/32 mi (mile)	1/16 mi (mile)	1/8 mi (mile)	1/4 mi (mile)	1/2 mi (mile)	1 mi (mile)	2 mi (mile)	4 mi (mile)	8 mi (mile)	16 mi (mile)	32 mi (mile)	64 mi (mile)	128 mi (mile)
Metric display	50 m	500 m	4 km	32 km	256 km								

# Destination Entry and Route Search

You can set the destination using various methods provided by the system.

Before Steps **MENU** → select  Destination Entry

## Open the [DESTINATION ENTRY] Menu

Change  
(Change  
Search Area)



Select **Change**

## Open the [DESTINATION ENTRY] Menu

Address



## Select



When narrowing  
down to city name  
Select **City**



When narrowing  
down to street name  
Select **Street**







Warnings

Do not keep your eyes fixed on the monitor screen or operate the system while driving.

Do not change the settings and destination locations while driving. Minimize the time spent viewing the monitor screen and listening to the voice guidance while driving. Operating the system will distract the driver from looking ahead of the vehicle and may cause an accident. Always stop the vehicle in a safe location before operating the system.

Route searches with the navigation system can include roads that you cannot drive on and roads that you are prohibited from driving on due to traffic regulations. Please comply with the traffic regulations.

### Select the desired Search Area

US1 : ID, OR, WA,

US2 : CA, NV

US3 : AZ, CO, MT, NM, UT, WY

US4 : IA, KS, MN, MO, ND, NE, SD

US5 : OK, TX

US6 : IL, IN, KY, MI, OH, WI

US7 : AR, AL, LA, MS, TN

US8 : CT, MA, ME, NH, NJ, NY, RI, VT

US9 : DC, DE, MD, PA, VA, WV

US10 : FL, GA, NC, SC

CAN : CANADA

→ OK

Any City :  
Cancel the city selection.

5 Nearest Cities :  
Displays list of 5 city names nearest the current position.

Input City Name :  
Displays the city name input screen.

Select the city name from the list

Enter the street name and select List

Select the street name from the list

Enter the house no.

Select OK

Direct destination input (page 40)

Enter the city name and select List

Select the city name from the list

Enter the street name and select List

Select the street name from the list

Enter the street name and select List

Select the street name from the list

Select the city name from the list

Enter the house no.

Select OK

For Character Entry, please refer to page 39.

# Destination Entry and Route Search

Point of interest

Open the [DESTINATION ENTRY] Menu



Select



When entering the destination point directly  
Select



When narrowing down to city name  
Select



When narrowing down to category name  
Select



When narrowing down to the nearest facility  
Select



When narrowing down to a phone number  
Select



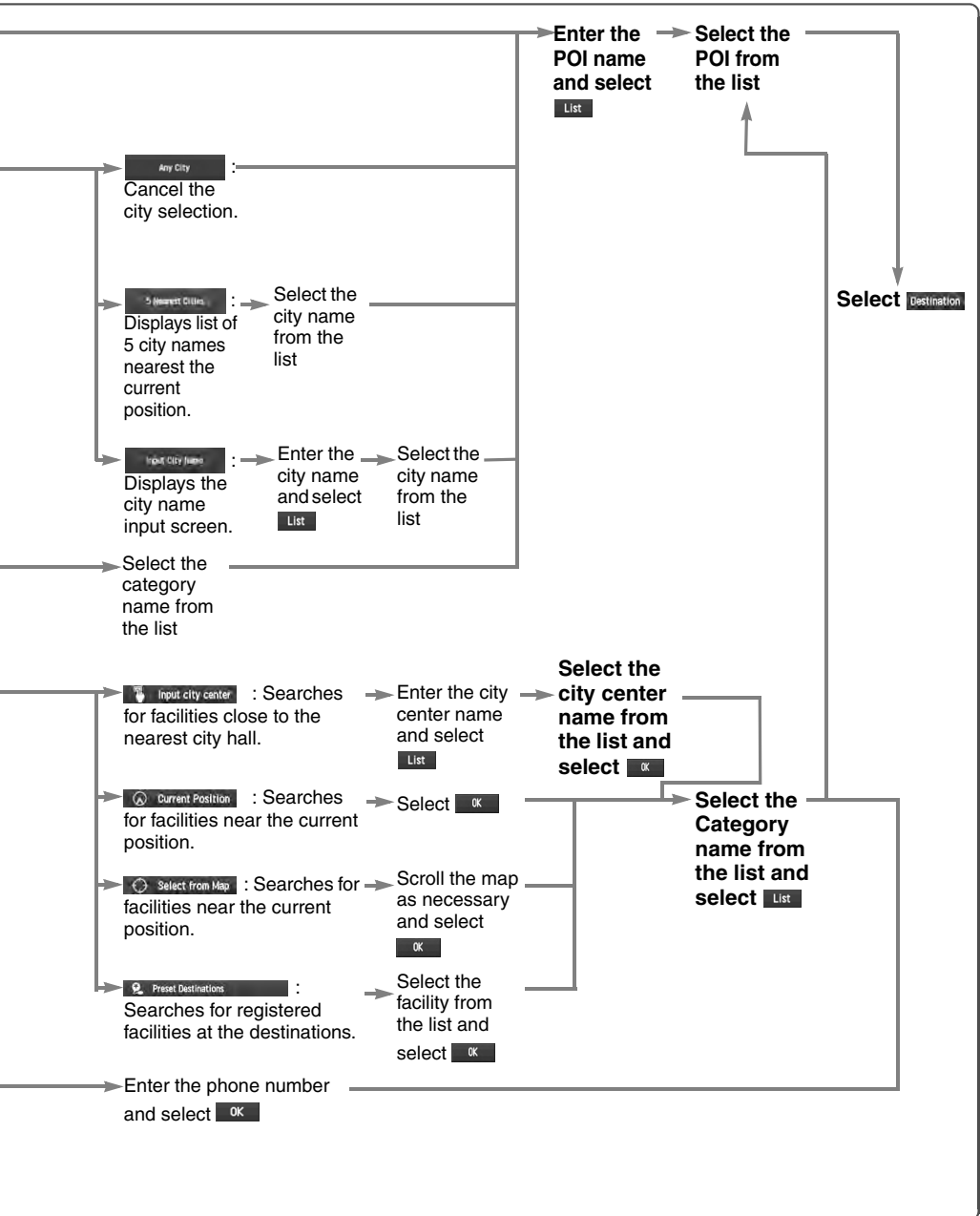

| For Character Entry, please refer to page 39.

# Destination Entry and Route Search

## Emergency

### Select



### When stopped

★ Police Station  
Displays the police station select screen.

+ Hospital  
Displays the hospital select screen.

### When driving

★ Nearby police station  
Sets the destination to the nearest police station automatically.

+ Nearby hospital  
Sets the destination to the nearest hospital automatically.

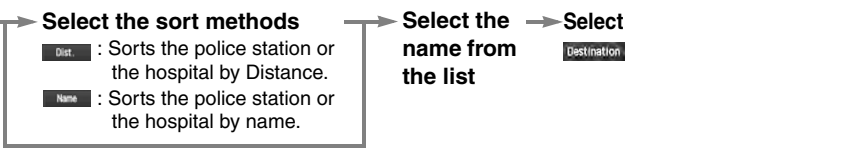

# Destination Entry and Route Search

Before Steps **MENU** → select  Destination Entry

Routing

Memory Point

Open the [DESTINATION ENTRY] Menu



Home

Select  Memory Point

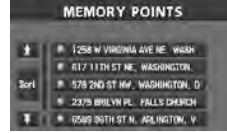

Select  Home

Preset Destination

Select  Preset Destinations

Previous Destination

Select  Previous Destinations

Intersection

Select  Intersection

Freeway On/  
Off Ramp

Select  Freeway On Ramp / Off Ramp

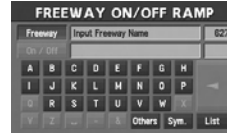

Coordinates

Select  Coordinates



Select from map

Select  Select from Map

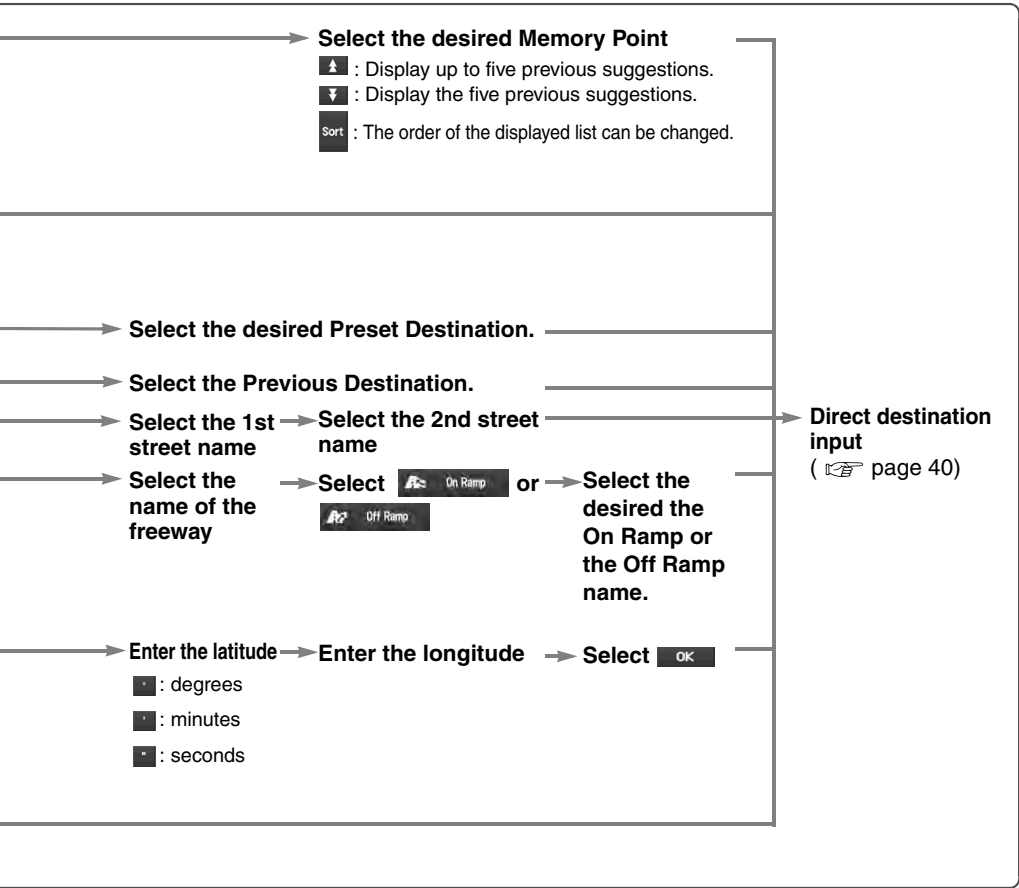

| For Character Entry, please refer to page 39.

# Quick POI

You can select one of the Six Categories on the menu or List Categories and then select the POI(s) to be displayed on the map.

Before Steps

Select **POI**

## Open the [QUICK POI]



Select the categories to be displayed up to a maximum of five.

→ **Show**

POI icon chart (👉 page 41)  
For categories other than the six displayed, select **List Categories** and select them from the list shown.

→ **Search Selected POI**

→ **Select the POI you want to find from the listed categories.**

After you make a selection, the point of interest you selected appears on the map.

**Route**: Search POI along the route during the guidance and show the list.

→ **POI Off**

Displaying POI(s) on a Map

Local Search

Deleting POI Markers

Routing

Before Steps

Displaying POI(s) on a Map (👉 above)

## Display the POI.



→ Select the desired POI by moving **○** on top of the POI icon. The name of the selected POI appears.

If no data is stored for the selected POI, the POI name is not displayed.

→ Select **Info.** (Information)

The POI(s) data is displayed.

Showing POI Data



# Character Entry

Street name,  
city name,  
and other  
input

Select the first several characters on the screen. (Step 1)

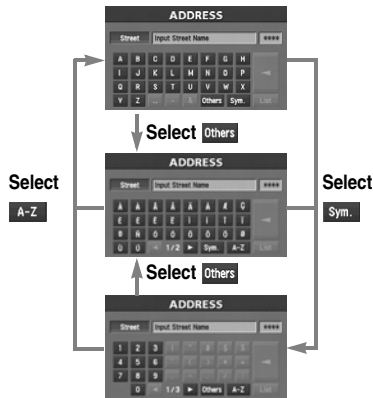

- : Move the cursor to the previous position and delete a character.
- : The list appears.

| Examples

Street: CANAL

Enter by selecting characters:

Street: MAIN STREET

Enter by selecting characters:

Select your target in the list.



Names of which spelling starts with the entered character appear. | If a desired name is not in the list, go back to Step 1, and try fewer characters.

- : Display up to five previous suggestions.
- : Display the previous suggestions.
- : Text flow (Right)
- : Text flow (Left)
- : The order of the displayed list can be changed. (Displayed list varies or may not be displayed depending on what was input.)
- : Additional text can be input. (Use when inputting additional characters after the list is displayed.)

Street: 52nd Ave.

Enter by selecting characters:

Routing

House phone  
number, and  
other input

Select the characters on the screen.



- : Move the cursor to the previous position and delete a character.

Select

# Direct Destination Input

## Direct Destination Input

1

Touch the map to set the cursor to the desired destination. The map scrolls faster the further away the touched location is from the cursor.

Scroll the map and change the map scale if necessary.



2

Select **Set as...**



3

Select **Destination**.

Route calculation will be carried out and the entire route will be displayed on the map.

Select **Way Point** (Way point) to set the address as a way point on your route (  page 46). You can set up to 5 way-points per trip.

4

Select **Guide**.

Route guidance begins using displayed route.

### Note

| If your desired route cannot be found, **Route opt.** (Route Options) allows the route option settings to be changed. (  page 42)

| Selecting **Guide** for five seconds or more will launch the Demo mode.

Operate after Step 3 of [Direct Destination Input]

## Selecting Route

4

The calculation route can be selected from one of three types namely, Quick (the fastest route), Altern. (the standard route), or Short (the shortest route).





5

Select **Info. (Information)**.

Details regarding the individual routes (i.e., required time total distance, roads used, etc.)

Select either **Quick**, **Altern.**, or **Short**, and then select **Guide**

when you have decided on the route to be used.

	Quick	Altern.	Short
	0h 3m	0h 4m	0h 3m
	1.7 miles	2.1 miles	1.7 miles
	0.0 miles	0.0 miles	0.0 miles
	0.0 miles	0.0 miles	0.0 miles

# POI Icons on Maps / Delete Destination

## n POI (Point of Interest) Icons

The following are POI icons shown on maps.

<div style="background-color: #333; color: white; padding: 2px; margin-bottom: 5px;"><b>Restaurant</b></div> <ul style="list-style-type: none"> <li> All restaurants</li> <li> American</li> <li> Chinese</li> <li> Continental</li> <li> Fast Food</li> <li> French</li> <li> Italian</li> <li> Japanese</li> <li> Mexican</li> <li> Seafood</li> <li> Thai</li> <li> Other Restaurants</li> </ul>	<div style="background-color: #333; color: white; padding: 2px; margin-bottom: 5px;"><b>Travel</b></div> <ul style="list-style-type: none"> <li> Bus Station</li> <li> Ferry Terminal</li> <li> Hotel</li> <li> Rental Car Agency</li> <li> Rest Area</li> <li> Train Station</li> <li> Airport (All Search Areas)</li> </ul>	<div style="background-color: #333; color: white; padding: 2px; margin-bottom: 5px;"><b>Community</b></div> <ul style="list-style-type: none"> <li> Convention Center</li> <li> Court House</li> <li> Government Offices</li> <li> Higher Education</li> <li> Hospital</li> <li> Library</li> <li> Park &amp; Recreation (All Search Areas)</li> <li> Police Office</li> <li> School</li> <li> City Center</li> </ul>
<div style="background-color: #333; color: white; padding: 2px; margin-bottom: 5px;"><b>Shopping</b></div> <ul style="list-style-type: none"> <li> Grocery Store</li> <li> Shopping Mall</li> </ul>	<div style="background-color: #333; color: white; padding: 2px; margin-bottom: 5px;"><b>Recreation</b></div> <ul style="list-style-type: none"> <li> Casino</li> <li> Golf Course</li> <li> Historical Monument</li> <li> Marina</li> <li> Museum</li> <li> Ski Resort</li> <li> Sports Complex</li> <li> Performing Arts</li> <li> Tourist Attraction (All Search Areas)</li> <li> Tourist Information</li> <li> Winery</li> <li> Amusement Park (All Search Areas)</li> </ul>	<div style="background-color: #333; color: white; padding: 2px; margin-bottom: 5px;"><b>Banking</b></div> <ul style="list-style-type: none"> <li> Bank</li> <li> ATM</li> </ul>
<div style="background-color: #333; color: white; padding: 2px; margin-bottom: 5px;"><b>Automotive</b></div> <ul style="list-style-type: none"> <li> Automobile Club</li> <li> Gas Station</li> <li> Parking</li> <li> Auto Service &amp; Maintenance</li> </ul>		<div style="background-color: #333; color: white; padding: 2px; margin-bottom: 5px;"><b>Other</b></div> <ul style="list-style-type: none"> <li> Business Facility</li> </ul>



Routing

Delete destination

MENU

→

Select

Cancel Guidance

→

Select

Yes

41

# Route Options

- During route guidance you can change the route options, stop or check the route.

Before Steps

**MENU**

→ select

 Route Options

Routing

Route Preferences

Open the [ROUTE OPTIONS] Menu



Select



Select the button for the location to be modified.

Modification of Destination or Way Point Positions

Select

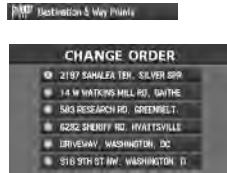

Select the way points to change the order. Change the destination and the passing order of the destination and way points.

Deletion of Destination or Way Points

Select the button corresponding to the destination or way point to be deleted.

Detour

Select



Turn List

Select



The Enter Route screen appears.



**n Do not keep your eyes fixed on the monitor screen or operate the system while driving**

Do not change the settings and destination locations while driving. Minimize the time spent viewing the monitor screen and listening to the voice guidance while driving. Operating the system will distract the driver from looking ahead of the vehicle and may cause an accident. Always stop the vehicle in a safe location and use the parking brake before operating the system.

Select **Prefer** or **Avoid** for toll roads, major roads, ferry, and restricted roads.

The route will not necessarily follow the specified conditions.

Select **Chg Loc.** → Move to location and then (Change Location). select **OK** .

Shows the map for the destination/way points.

Press **▲** **▼** to change the order.

Select **Delete** → **Yes** :

**No** :Cancel the deletion

**1mile** **3miles** **5miles** :

**Whole Route**

Searches the detour routes at one, three, and five miles from the present position to the selected routes. (Display range varies according to the set distance of the selected route.)

Whole Route searches the route that detours from the present position for all routes.

Select **Avoid** from

the roads to be avoided.

**Yes** :  
**No** :Cancel the setting

NAVI → Guide

NAVI → Guide

NAVI

Guide

NAVI → Guide

# Route Options

Before Steps **MENU** → select  Route Options

Open the  
[ROUTE  
OPTIONS] Menu



Select  Display Route



Select  Route Preview



Display  
Preview

Route  
Preview

Routing

**Use the buttons displayed on-screen to carry out a simulation run.**

- : Move to the start point.
- : Carry out a simulation run in the direction of the start point. When the Simulation starts the button will be displayed as , and when selected, it will cause the Simulation to advance quickly.
- : Stop the simulation run.
- : Carry out a simulation run in the direction of the destination. When the Simulation starts the button will be displayed as , and when selected, it will cause the Simulation to advance quickly.
- : Move to the destination.
- Edit** : Displays the [EDIT ROUTE PREVIEW] screen.

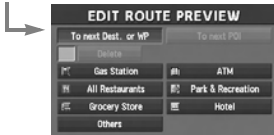

- : Stops at the destination or the next way-point.
  - : Stops at a point of interest which has been setup on the route.
  - : Delete the POI which has been selected.
- POIs: Display the six POIs from Quick-POI storage. When one of these is selected, it will be displayed on the map; furthermore, can be selected to display items other than shown here. For more details, refer to page 22.

RTN

# Address Book

| You can, edit, or delete any marked point.

Before Steps **MENU** → select  Address Book

Memory Point Storage

Open the [ADDRESS BOOK]

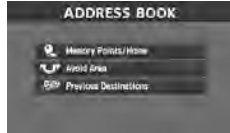

Select



Memory Point Confirmation and Modification

Preset Destinations or Home Storage

Memory Point Deletion

All Memory Point Deletion

Displays Icons at Memory Points

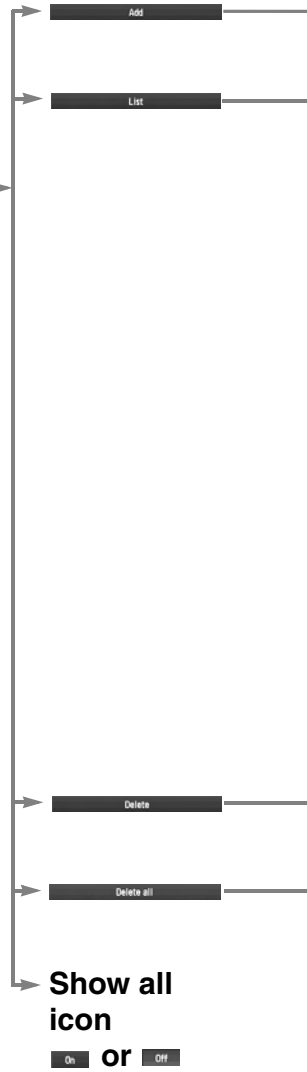

Address Book



→ **Set a memory point using your preferred method.**

→ **Select a memory point to be modified**

**Icon** : Allows the display icon to be selected. Page 1 and 2 contain standard icons, whereas the With Sound page contains icons which also playback sounds. (With direction icon function)  
The beep alert only activates when the vehicle approaches to within about 500m of the memory point from the set direction.

**Name** : Allows the name to be changed. When editing has been completed, select **OK**. Furthermore, select **On** to display names on the map, or **Off** if these names are not to be displayed.

**Position** : Allows memory points to be checked and modified on the map screen. After checking.

→ **OK**

**Tel.** : Allows the telephone number to be modified. When editing has been completed, select **OK**.

→ **Select a memory point to be stored in Preset Destinations or Home.**

**Category** : Allows the storage category to be changed. Select the button corresponding to the new category.

**Preset Destinations**

: Changes the category to Preset Destinations

**Home**

: Changes the category to Home

→ **Select a memory point to be deleted.**

**Yes**

**No** : Cancel the deletion.

**Yes**

**No** : Cancel the deletion.

# Address Book

Before Steps

**MENU**

→ select

 Address Book

**Avoid Area Storage**

**Open the [ADDRESS BOOK]**

**Avoid Area Confirmation and Modification**

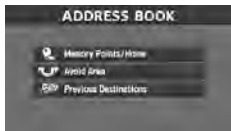

**Select**

 Avoid Area

**Avoid Area Deletion**

**All Avoid Area Deletion**

**Category Name Modification**

**Previous Destination Deletion**

**All Preset Destination Deletion**

**Select**

 Preset Destinations

Address Book

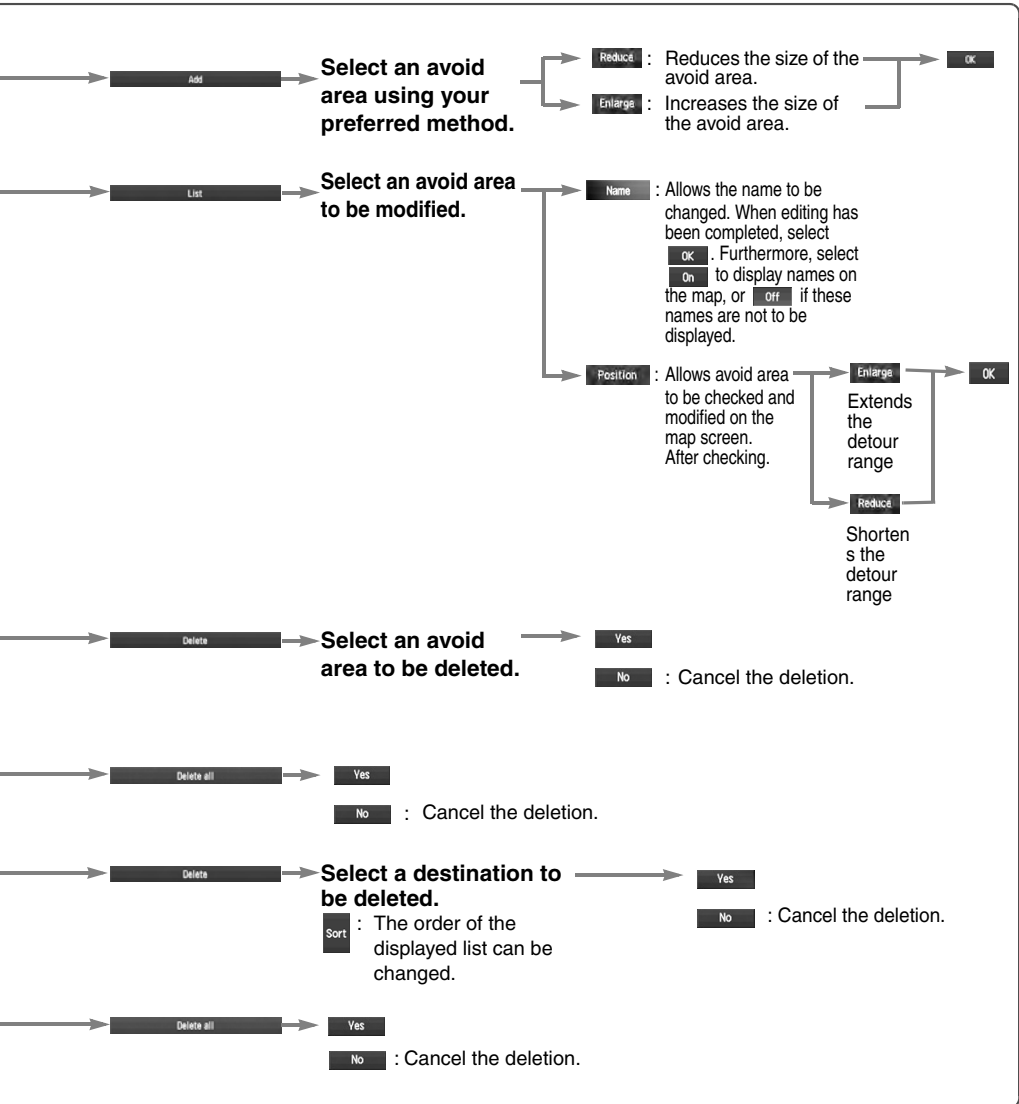

# Voice Recognition

Voice control can be carried out by simply Pressing VOICE switch on the steering wheel switch and using a voice command (page 51) spoken into the microphone.

## Voice Recognition Structure

### I Microphone surface

Voice entry recognition.

Mazda CX-9

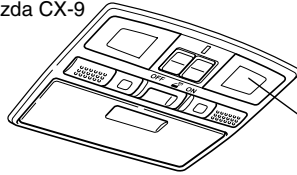

Mazda CX-7

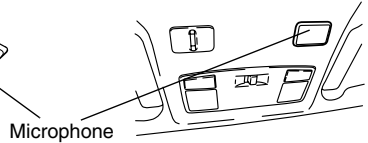

Microphone

### I VOICE switch on the steering wheel switch

Use for switching to voice recognition or canceling.

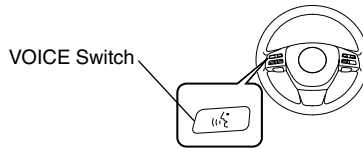

VOICE Switch

## Language Select

Set up the language in advance.

1

Press **MENU**

2

select →

select → select

3

Select your preferred language from the list.

**Note**

To return to current position screen, press **NAVI**.

## Basic Usage Pattern

1

Press VOICE switch on the steering wheel switch.

2

Speak the desired voice command.

## Cancel Voice Recognition

1

Long press VOICE switch on the steering wheel switch. (Press it more than 0.7 second.)

## Avoiding Voice Recognition Errors.

Read the notes listed below to allow the Voice Recognition function to recognize your voice properly.

- l Speak a voice command clearly.
- l Keep yourself in a safe driving position. Do not face or approach the microphone to make your voice command recognizable.

Voice recognition may fail to recognize your command due to voice tone. If this happens, change the tone of your voice by speaking more loudly and clearly.

- l Keep the inside of the vehicle quiet when making a voice command. Your command may be compromised by noises made by people, blinkers, the horn, vehicle vibration, and noises from outside the vehicle.
- l Use the language you selected in voice recognition.

Please be aware that the voice recognition may error or not function despite following the above points.

### Note

VOICE switch cannot be used while a Bluetooth Hands-Free is being used. (Mazda CX-9 only)

## Voice Recognition Command

The following voice commands can be used with voice control.

<b>Shortcut Commands</b>
[Show] <b>Current</b> (Position/Location)
[Show] <b>Map</b>
<b>Repeat</b> [Voice] [Guidance]
<b>Cancel</b>
<b>Map Operation Commands</b>
<b>Zoom In</b>
<b>Zoom Out</b>
<b>Zoom In Maximum</b>
<b>Zoom Out Maximum</b>
<b>Right Map Zoom In</b>
<b>Right Map Zoom Out</b>
<b>Right Map</b> (Zoom In Maximum/Minimum Scale)
<b>Right Map</b> (Zoom Out Maximum/Maximum Scale)
[Change to/Show] <b>North up</b> [Mode]
[Change to/Show] <b>Heading up</b> [Mode]
[Change] <b>Map Direction</b>
<b>Right Map</b> [Change to/Show] <b>North up</b> [Mode]
<b>Right Map</b> [Change to/Show] <b>Heading up</b> [Mode]
<b>Right Map</b> [Change Map] <b>Direction</b>
[Show/Change to] <b>Dual Map</b> [Mode]
[Show/Change to] <b>Single Map</b> [Mode]
(Store/Mark) [This Point]
<b>POI Display Commands</b>
<b>Automobile Club</b>
<b>Gas Station/Gas</b>
<b>Parking/Parking Lot/Parking Garage/Car Park</b>
<b>Auto Service &amp; Maintenance/Auto Service</b>
<b>ATM</b>
<b>Bank</b>
<b>Town Center/City Center</b>
<b>Convention Center/Exhibition Center</b>
<b>Court House</b>
<b>Government Offices</b>
<b>Higher Education/University/College</b>
<b>Hospital</b>
<b>Library</b>
<b>Parks &amp; Recreation/Park &amp; Recreation</b>
<b>Police Station</b>

<b>School</b>
<b>Amusement Park</b>
<b>Casino</b>
<b>Golf Course</b>
<b>Historical Monument</b>
<b>Marina</b>
<b>Museum</b>
<b>Ski Resort/Skiing</b>
<b>Sports Complex/Stadium</b>
<b>Performing Arts</b>
<b>Tourist Attraction</b>
<b>Tourist Information</b>
<b>Winery</b>
<b>Restaurant/I'm Hungry/Show Restaurant</b>
<b>American Restaurant/American Food</b>
<b>Chinese Restaurant/Chinese Food</b>
<b>Continental Restaurant/Continental Food</b>
<b>Fast Food/Fast Food Restaurant</b>
<b>French Restaurant/French Food</b>
<b>Italian Restaurant/Italian Food</b>
<b>Japanese Restaurant/Japanese Food</b>
<b>Mexican Restaurant/Mexican Food</b>
<b>Seafood Restaurant/Seafood</b>
<b>Thai Restaurant/Thai Food</b>
<b>Other Restaurant/Other Food</b>
<b>Grocery Store</b>
<b>Shopping Mall</b>
<b>Airport</b>
<b>Bus Station</b>
<b>Ferry Terminal</b>
<b>Hotel</b>
<b>Rental Car Agency</b>
<b>Rest Area</b>
<b>Train Station</b>
<b>Business Facility</b>
<b>POI Off</b>
<b>Destination Operation Commands</b>
[Go] <b>Home</b>
<b>Enter Destination</b>
<b>Add to Waypoint</b>

(Go to/Previous) <b>Starting Point</b>
[Go to] <b>Previous Destination</b>
[Go to] <b>Preset Destination</b> [Number] 1
[Go to] <b>Preset Destination</b> [Number] 2
[Go to] <b>Preset Destination</b> [Number] 3
[Go to] <b>Preset Destination</b> [Number] 4
[Go to] <b>Preset Destination</b> [Number] 5
<b>Cancel</b>
<b>Guidance Commands</b>
<b>Louder</b>
<b>Softer</b>
[Show] (Whole/Entire) <b>Route</b> [Map]
[Show] <b>Next Way Point</b> [Map]
<b>Show First Way Point</b> [Map]
<b>Show Second Way Point</b> [Map]
<b>Show Third Way Point</b> [Map]
<b>Show Fourth Way Point</b> [Map]
<b>Show Fifth Way Point</b> [Map]
<b>Show Destination</b> [Map]
(Delete/Cancel) <b>Next Way Point</b>
<b>Yes</b>
<b>No</b>
(Delete/Cancel) <b>Destination</b>
(Delete/Cancel) <b>All Way Points and Destination</b>
<b>Voice Guidance Off</b>
<b>Voice Guidance On</b>
<b>Quick</b>
<b>Alternative</b>
<b>Short</b>
<b>Detour</b>
<b>Detour Entire Route</b>
[Change to] <b>Arrow</b> (Guide/Guidance)
[Change to] <b>Turn List</b> (Guide/Guidance)
[Change to] <b>Freeway</b> (Guide/Guidance)
[Change to] <b>Intersection</b> (Guide/Guidance)
<b>Display Commands</b>
<b>display</b> [set] <b>day</b> [mode]
<b>display</b> [set] <b>night</b> [mode]
<b>display</b> [set] <b>auto</b> [mode]

( ): Indicates the commands to be the object of “/”

[ ]: Recognizes without saying the command in “[ ]”

“/”: Recognizes when saying either commands before and after “/”

# Volume Adjustment

You can adjust the volume control for the voice guidance.

Before Steps

**MENU**

→ select  Volume

## Open the [VOLUME] screen



**1** Select the appropriate button to set the volume to between **1** (minimum) and **7** (maximum).

**Off** : Sound output will be muted.

**2** Press the **(NAVI)** button to return to the current vehicle position screen.

# Precautions/System Performance

## Voice Guidance



- | The navigation system is just a support system for the driver. The driver should always pay attention to the traffic situation to safely make decisions. You may be unable at times to arrive at your destination due to out-of-date information on a map disc. You should be especially careful when selecting an urgent destination such as a hospital or a police station.
- | Your route may sometimes include roads that are not open to vehicles or are closed due to traffic regulations. Please comply with the local traffic regulations.
- | Do not change the settings and destination locations while driving. Minimize the time spent viewing the monitor screen and listening to the voice guidance while driving. Operating the system will distract the driver from looking ahead of the vehicle and may cause an accident. Always stop the vehicle in a safe location and use the parking brake before operating the system.

Voice guidance has the following functions:

### n Intersection guidance

- | The system voice announces the distance to an upcoming turn and the turning direction.  
⇒ This guidance function is automatic. Therefore, you do not have to set it, and it cannot be disabled.
- | The system vocally announces the distance to an upcoming highway branching point or junction.

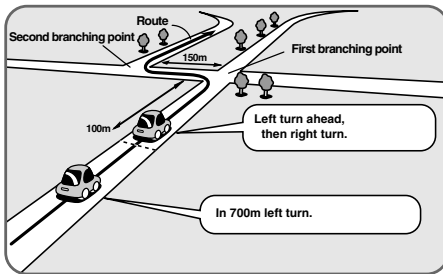

When two intersections are close together, the voice guidance may be late.

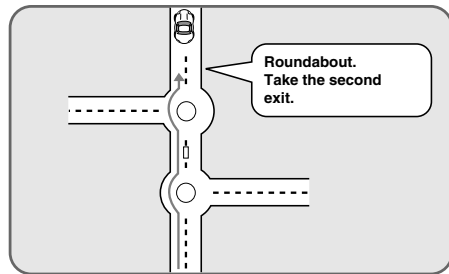

When two roundabouts are close together, the voice guidance for the second may be late.

If necessary

## GPS

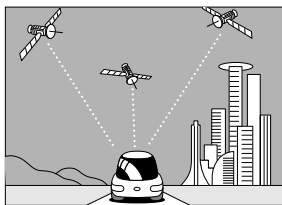

GPS is a position detecting system utilizing the signals from GPS satellites deployed by the U.S. Department of Defense. The Mobile Navigation System uses input from three or more satellites and calculates the vehicle position based on the principle of triangulation.

The positioning accuracy of the system corresponds to the error display of the GPS which is from about 30 to 200 meters.

- | If you are using the system for the first time, or if you have not used it for some time, it takes about 5 minutes (or about 2 minutes in open areas) to calculate your vehicle's position.

### n GPS signal reception is poor in the following places

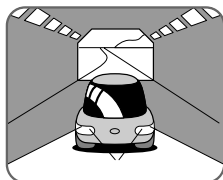

In tunnels

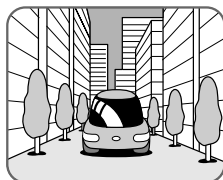

Among high-rise buildings

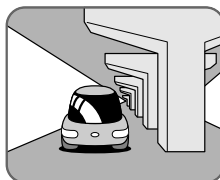

Under elevated roads

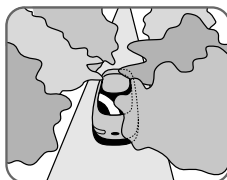

In wooded areas

- | The GPS satellites are controlled by the U.S. Defense Department, which may intentionally lower positioning accuracy. In such cases, there may be vehicle position deviations.
- | There may be vehicle position deviations for some time until GPS signals are received after turning on the ignition.

## Map Matching

This function compares your vehicle's tracking data with the road data on the map disc, applies dead reckoning to determine the road you are driving on, and displays your vehicle on that road on the map.

- | Intelligent map matching addresses the following problems to achieve high accuracy in vehicle positioning.

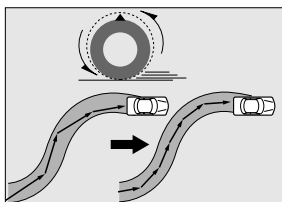

### Position Correction for Elevated Roads

Position accuracy is improved by detecting if the vehicle is running on or under an elevated road.

### Position Correction for Parking Garages

Position accuracy is improved by detecting if the vehicle is driving in an elevated or underground parking garage.

### High-precision Gyrosensor

A gyro detects turns with an accuracy of  $0.05^\circ$  per second. Combined with a speed sensor, it enables the system to display the current vehicle position even where GPS signals may be blocked.

- | Using a spare tire in place of the regular one may cause vehicle position deviations.
- | Any difference between the direction which your vehicle actually travels and that shown on the map is automatically eliminated by azimuth correction.



# Precautions/System Performance

## Positioning Accuracy

In the following situations, your vehicle position may not be displayed correctly on the map. But, as you keep driving, your vehicle position will be automatically corrected utilizing map matching and GPS data.

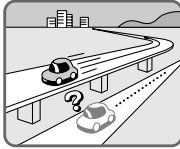

Running on an elevated road

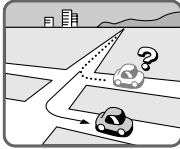

Making a turn after driving on a long straight road



Running on a steep mountain road

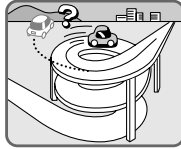

Running on a spiral road

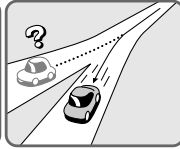

Entering an intersection where a road branches off at a small angle

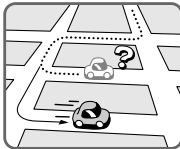

Running on gridiron layout of roads



Running on a slippery road with tire chains

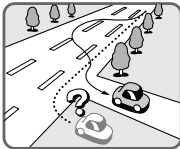

Snaking on a wide road

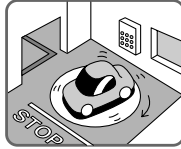

When your vehicle is on a turntable with the ignition turned off



After getting off a ferryboat or vehicle train

## Route Guide

Although you may encounter the following problems in route guide, there is nothing wrong with the system.

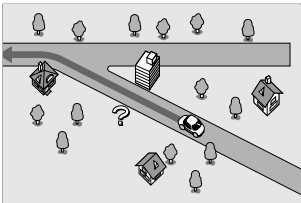

For certain intersection shapes, the upcoming turn or the name of the intersection may not be announced.

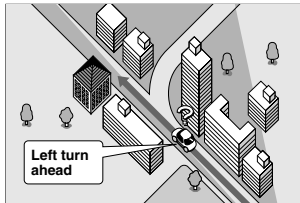

For certain intersection shapes, you may be prompted to turn right or left when you should actually stay on the same road.

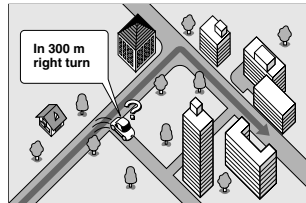

Voice guidance for the planned route may continue even after you have deviated from that route such as having turned too early.

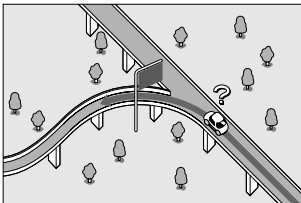

Some points where the road divides on highways or toll roads may not be displayed or announced.

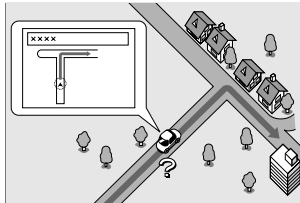

The Intersection Zoom Map may not always agree with the actual shape of the intersection.

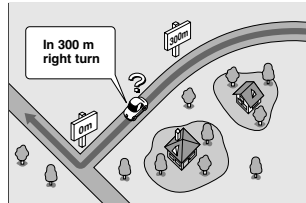

The announced distance to an upcoming turn may differ slightly from reality.

If necessary



The navigation system is just a support system for the driver. The driver should always pay attention to the traffic situation to safely make decisions. You may be unable to arrive at your destination due to out-of-date information on a map disc. You should be especially careful when selecting an urgent destination such as a hospital or a police station.

## Route Search

Although you may encounter the following problems in a route search, there is nothing wrong with the system.

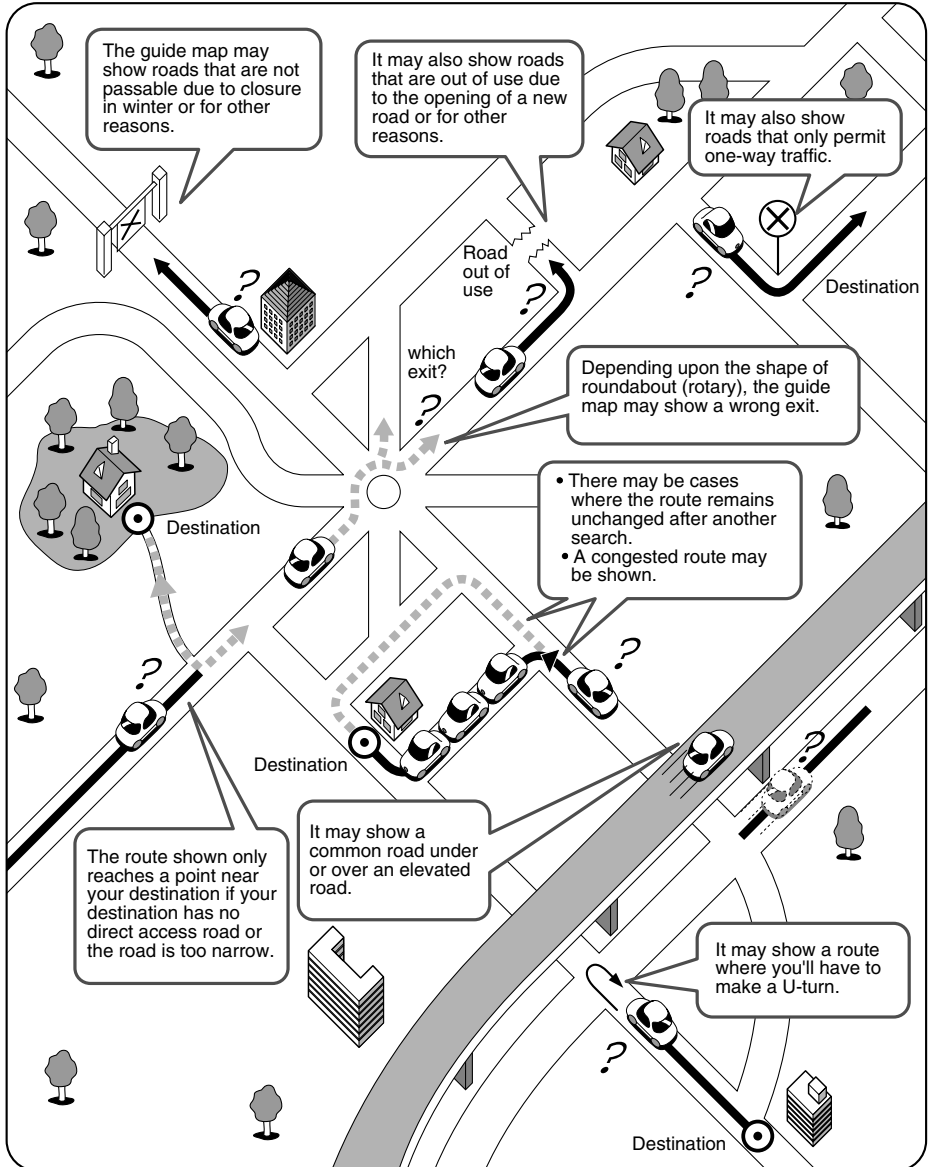

# Troubleshooting

## Verification First

### Note

There may be some problems due to operational errors or mistakes. Please read this manual again and verify that there really is a problem before calling an Expert Dealer, we recommend an Authorized Mazda Dealer to ask for repair services.

Symptom	Check point
No picture	<ul style="list-style-type: none"><li>  Check if a fuse has blown.<ul style="list-style-type: none"><li>➔ Consult an Expert Dealer, we recommend an Authorized Mazda Dealer.</li></ul></li> <li>  Check if the voltage level of the vehicle battery is low.<ul style="list-style-type: none"><li>➔ Recharge the battery or change batteries.</li></ul></li></ul>
Display does not open or close	
The vehicle position is not correct	<ul style="list-style-type: none"><li>  Check if the vehicle position changed when ACC was set to OFF. When, for example,<ul style="list-style-type: none"><li>• The vehicle was transported by a ferry boat.</li><li>• The vehicle was rotated on a turn table in a parking lot.</li><li>• The vehicle was transported by a tow track or other such vehicle.<ul style="list-style-type: none"><li>➔ Drive the vehicle for a while where you are receiving GPS signals.</li></ul></li></ul></li></ul>

If necessary

Symptom	Check point
<p><b>No GPS symbols are displayed</b></p>	<ul style="list-style-type: none"> <li>  GPS signals may not be received because of obstructions. After moving the vehicle away from obstructions, the GPS signals can be received.</li> </ul>
<p><b>The vehicle position is not displayed</b></p>	<ul style="list-style-type: none"> <li>  Check if the mode is set to the current position screen.               <ul style="list-style-type: none"> <li>➔ Press <b>NAVI</b></li> </ul> </li> </ul>
<p><b>No voice guidance</b></p>	<ul style="list-style-type: none"> <li>  Check if the volume control for the voice guidance has been turned off.</li> <li>  Check if the vehicle is off the route.               <ul style="list-style-type: none"> <li>➔ Repeat the route search while checking the route guide screen.</li> </ul> </li> <li>  Check if you are driving the vehicle in the wrong direction on the route.               <ul style="list-style-type: none"> <li>➔ Repeat the route search checking the direction of the destination.</li> </ul> </li> </ul>
<p><b>Buttons on the remote control do not beep</b></p>	<ul style="list-style-type: none"> <li>  Check if [Beep] is set to [Off] (  page 21).</li> </ul>

# Troubleshooting

## Error Messages

Error message	Solution
<b>Please insert a MAP DVD.</b>	<ul style="list-style-type: none"><li>  The disc is not installed.<ul style="list-style-type: none"><li>➔ Check if the disk is installed. If installed, check if the installed disk is correct.</li></ul></li></ul>
<b>MAP DVD-Read Error</b>	<ul style="list-style-type: none"><li>  The disc is wet, dirty, scratched, or upside down, or the disc cannot be played with this unit or the incorrect disk is installed.<ul style="list-style-type: none"><li>➔ Eject the disc and check it (  page 13).</li></ul></li></ul>
<b>The disc installed is not a MAP DVD.</b>	

# Maintenance

## Care of the Product

### n **Cleaning this product**

Use a dry, soft cloth to wipe it.

### n **Cautions for cleaning**

Never use solvents such as benzene and thinners, they could mar the surface of the unit.

### n **Map disc**

If you require the latest map disc, consult an Expert Dealer, we recommend an Authorized Mazda Dealer.

## Handling and Care of Map Discs

### n **How to hold the disc**

- | Do not touch the underside of the disc.
- | Do not scratch the disc.
- | Do not bend the disc.
- | When not in use, keep the disc in the case.

Label side



### n **Disc Cleaning**

- | Use a dry, soft cloth to wipe from the center outward.



<Right>



<Wrong>

### n **Do not leave discs in the following places:**

- | Direct sunlight
- | Near car heaters
- | In dirty, dusty and damp areas
- | On seats and dashboards

## Audio system

- n Audio Operation
    - l Operating Tips for Audio system ..... 62  
(Radio Reception), (Operating Tips for In-Dash CD Changer),  
(Operating tips for MP3), (CD-TEXT)
    - l Operating Tips for Display ..... 68
    - l Beep sound and voice guidance restrictions while using Bluetooth  
Hands-Free (Mazda CX-9 only)..... 68
    - l Power/Volume/Sound Controls..... 69  
(Power ON/OFF), (Volume adjustment), (Audio sound adjustment),  
(Sound quality adjustment), (Volume balance adjustment), (AudioPilot™),  
(Centerpoint®), (Rear seat-optimized (With Rear Entertainment System)  
(Mazda CX-9 only)), (Surround)
    - l Operating the Radio ..... 73  
(Radio ON), (Band selection), (Tuning), (Manual tuning), (Seek tuning),  
(Scan tuning), (Preset channel tuning), (Auto memory tuning),  
(Audio Sound Adjustment), (Satellite Radio (SAT))
    - l Operating the In-Dash CD Changer ..... 76  
(Inserting the CD), (During CD playback), (During MP3 CD playback),  
(Normal insertion), (Inserting CDs into desired tray number),  
(Multiple insertion), (Normal ejection),  
(Ejecting CDs from desired tray number), (Multiple ejection),  
(Playing), (Fast-forward/Reverse), (Track search), (Disc search),  
(Folder search (during MP3 CD playback)), (Music scan), (Repeat play),  
(Audio sound adjustment), (Operating tips for audio control switch),  
(Safety Certification)
-

# Audio Operation

## Operating Tips for Audio system

### n Radio Reception

#### AM characteristics

AM signals bend around such things as buildings or mountains and bounce off the ionosphere. Therefore, they can reach longer distances than FM signals. Because of this, two stations may sometimes be picked up on the same frequency at the same time.

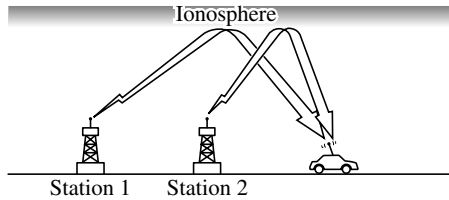

#### FM characteristics

An FM broadcast range is usually about 40–50 km (25–30 miles) from the source.

Because of extra coding needed to break the sound into two channels, stereo FM has even less range than monaural (non-stereo) FM.

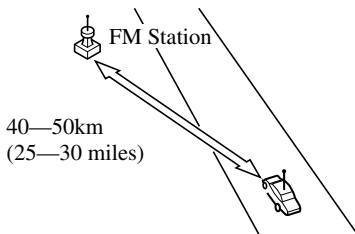

Signals from an FM transmitter are similar to beams of light because they do not bend around corners, but they do reflect.

Unlike AM signals, FM signals cannot travel beyond the horizon. Therefore, FM stations cannot be received at the great distances possible with AM reception.

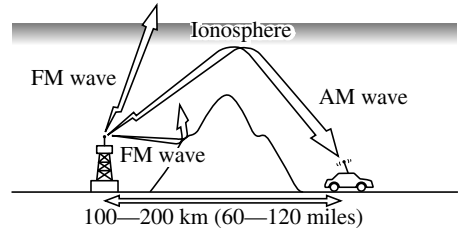

Atmospheric conditions can also affect FM reception. High humidity will cause poor reception. However, cloudy days may provide better reception than clear days.

#### Multipath noise

Since FM signals can be reflected by obstructions, it is possible to receive both the direct signal and the reflected signal at the same time. This causes a slight delay in reception and may be heard as a broken sound or a distortion. This problem may also be encountered when in close proximity to the transmitter.

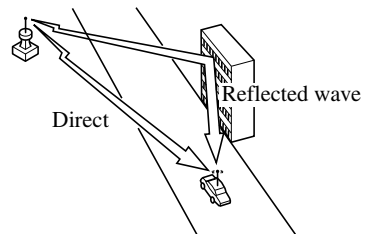



### Flutter/Skip noise

Signals from an FM transmitter move in straight lines and become weak in valleys between tall buildings, mountains, and other obstacles. When a vehicle passes through such an area, the reception conditions may change suddenly, resulting in annoying noise.

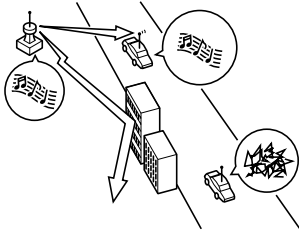

### Weak signal noise

In suburban areas, broadcast signals become weak because of distance from the transmitter. Reception in such fringe areas is characterized by sound breakup.

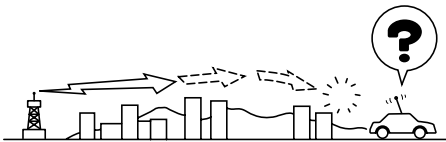

### Strong signal noise

This occurs very close to a transmitter tower. The broadcast signals are extremely strong, so the result is noise and sound breakup at the radio receiver.

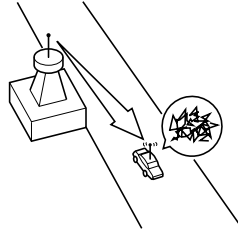

### Station drift noise

When a vehicle reaches the area of two strong stations broadcasting at similar frequencies, the original station may be temporarily lost and the second station picked up. At this time there will be some noise from this disturbance.

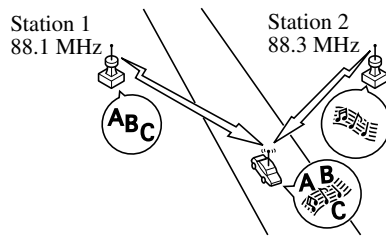

## Operating Tips for In-Dash CD Changer

### Condensation phenomenon

Immediately after turning on the heater when the vehicle is cold, the CD or optical components (prism and lens) in the In-dash CD changer may become clouded with condensation. At this time, the CD will eject immediately when placed in the unit. A clouded CD can be corrected simply by wiping it with a soft cloth. Clouded optical components will clear naturally in about an hour. Wait for normal operation to return before attempting to use the unit.

### Handling the In-dash CD changer

The following precautions should be observed.

- Do not spill any liquid on the audio system.

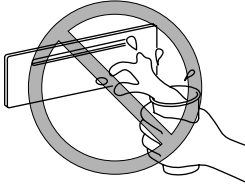

- Do not insert any objects, other than CDs, into the slot.

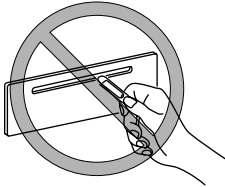

- The CD revolves at high speed within the unit. Defective (cracked or badly bent) CDs should never be used.

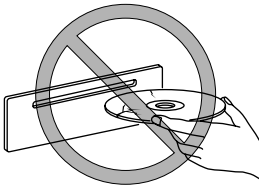

- Do not use non-conventional discs such as heart-shaped, octagonal discs, etc. The disc may not eject resulting in a malfunction.

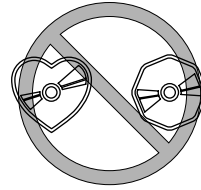

- If the memory portion of the CD is transparent or translucent, do not use the disc.

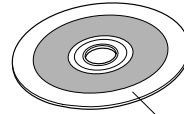

Transparent

- A new CD may have rough edges on its inner and outer perimeters. If a disc with rough edges is used, proper setting will not be possible and the In-dash CD changer will not play the CD. In addition, the disc may not eject resulting in a malfunction. Remove the rough edges in advance by using a ball-point pen or pencil as shown below. To remove the rough edges, rub the side of the pen or pencil against the inner and outer perimeter of the CD.

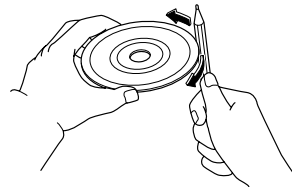

- When driving over uneven surfaces, the sound may jump.

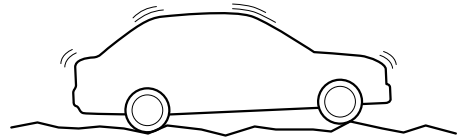

- | Use discs that have been legitimately produced. If illegally-copied discs such as pirated discs are used, the system may not operate properly.
- | Be sure never to touch the signal surface when handling the CDs. Pick up a CD by grasping the outer edge or the edge of the hole and the outer edge.

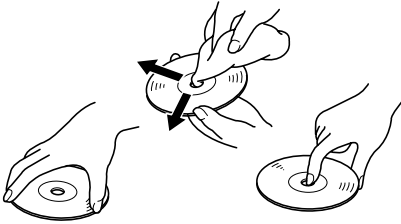

- | Do not stick paper or tape on the CD. Avoid scratching the reverse side (the side without a label). The disc may not eject resulting in a malfunction.
- | Dust, finger smudges, and dirt can decrease the amount of light reflected from the signal surface, thus affecting sound quality. If the CD should become soiled, gently wipe it with a soft cloth from the center of the CD to the edge.
- | Do not use record sprays, antistatic agents, or household spray cleaners. Volatile chemicals such as benzene and thinner can also damage the surface of the CD and must not be used. Anything that can damage, warp, or fog plastic should never be used to clean CDs.
- | Insert discs one by one. If two discs are inserted at the same time, the system may not operate properly.
- | The In-dash CD changer ejects the CD if the CD is inserted upside down. Also dirty and/or defective CDs may be ejected.
- | Do not insert any disc with a peel-off seal affixed to it.

## Handling the In-dash CD changer

- | This unit may not be able to play certain CD-R/CD-RWs made using a computer or music CD recorder due to disc characteristics, scratches, smudges, dirt, etc., or due to dust or condensation on the lens inside the unit.
- | Storing CDs in the vehicle exposed to direct sunlight or high temperature may damage the CD-R/CD-RWs, and make them unplayable.
- | CD-R/CD-RW exceeding 700 MB cannot be played.
- | This unit may not be able to play certain discs made using a computer due to the application (writing software) setting used. (For details, consult the store where the application was purchased.)
- | It is possible that certain text data, such as titles, recorded on a CD-R/CD-RW may not be displayed when musical data (CD-DA) is playing.
- | The period from when a CD-RW is inserted to when it begins playing is longer than a normal CD or CD-R.
- | Completely read the instruction manual and cautions for CD-R/CD-RWs.
- | Do not use discs with cellophane tape adhering, partially peeled off labels, or adhesive material exuding from the edges of the CD label. Also, do not use discs with a commercially-available CD-R label affixed. The disc may not eject resulting in a malfunction.

## n Operating tips for MP3

### NOTE

Supply of this product only conveys a license for private, non-commercial use and does not convey a license nor imply any right to use this product in any commercial (i.e. revenue-generating) real time broadcasting (terrestrial, satellite, cable and/or any other media), broadcasting/streaming via the Internet, intranets and/or other networks or in other electronic content distribution systems, such as pay-audio or audio-ondemand applications. An independent license for such use is required. For details, please visit <http://www.mp3licensing.com>.

- | This audio system handles MP3 files that have been recorded on CD-R/CDRW/CD-ROMs. Discs that have been recorded using the following formats can be played:
  - ISO9660 level 1
  - ISO 9660 level 2
  - Joliet extended format
  - Romeo extended format
- | This unit handles MP3 files conforming to the MP3 format containing both header frames and data frames.
- | If a disc has both music data (CD-DA) and MP3 files, playback of the two file types differs depending on how the disc was recorded.
- | Packet written discs cannot be played on this unit.
- | This unit does not play CDs recorded using MP3i (MP3 interactive), MP3 PRO and RIFF MP3 formats.

### CAUTION

This unit can only play MP3 files that have an MP3 file extension (.mp3) attached. Do not attach an MP3 file extension to any other type file as it could cause noise to be emitted or a malfunction in the unit.

### Specialized glossary

#### MP3

Abbreviation for “MPEG Audio Layer 3”. A technical standard for audio compression as decided by an ISO (International Organization for Standardization) MPEG working group. Use of MP3 allows for audio data to be compressed to approximately a tenth of the source data size.

#### ISO 9660

An international standard for logical formatting of CD-ROM files and folders. It is divided into three separate levels based on differences in file naming procedures, data configuration and other characteristics.

#### Bit rate

Refers to the volume of data per second, expressed in bps (bits per second). Generally, the larger the number of the transfer bit rate when compressing an MP3 file, the more information regarding musical reproduction it carries, and therefore the better the sound quality.

#### Packet writing

A general term for the method, similar to that used for floppy discs or hard drives, of recording the required file in a single increment on a CD-R and similar.

## n CD-TEXT

Music CDs are available in which separate music data including album/title names, music name, artist name, and other textual information can be recorded. The data standard for recording textual information to these kinds of music CDs is termed CD-TEXT.

There are two regions of a CD where textual information can be recorded which include regions related to the entire CD (Attributes recorded for the entire CD) and individual track regions (Attributes recorded for individual tracks).

As for this audio unit, textual information (Track/artist information), which can be recorded on individual track regions, appears on the display. Textual information (Album/artist and other information), which can be recorded to regions related to the entire CD, does not appear on the display.

Unless all the textual information is input in one-byte characters, a dotted line (---) will appear in place of the textual information, even if one of the characters is not a one-byte character (Two-byte character).

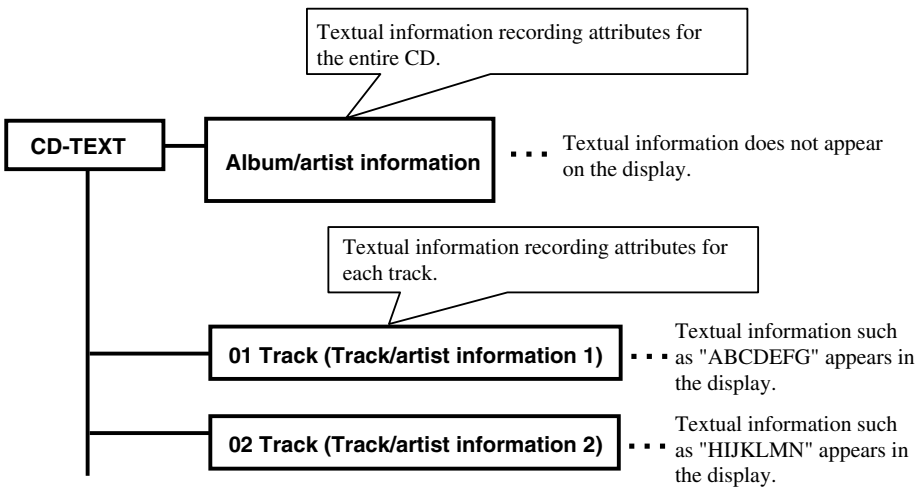

## Operating Tips for Display

- n **Do not place any objects on the dashboard. If you drop any objects onto the dashboard or spill liquid on it, it may result in system malfunction.**
- n **Be careful not to pinch your hands or fingers when the liquid crystal display is closed.**
- n **Do not open/close the liquid crystal display manually. It may damage the equipment.**

- | The liquid crystal display may not open if the power supply had been interrupted due to the vehicle battery being disconnected.
- | If the liquid crystal display stays open/closed (or partly opened) and does not move when the liquid crystal display is pressed, turn the ignition switch and then on again. Then try the open/close operation again. If the liquid crystal display still does not move, contact an Authorized Mazda Dealer.

### **Beep sound and voice guidance restrictions while using Bluetooth Hands-Free (Mazda CX-9 only)**

The beep sound and voice guidance related to the audio operation are not heard while a Bluetooth Hands-Free is being used.

# Power/Volume/Sound Controls

Mazda CX-9

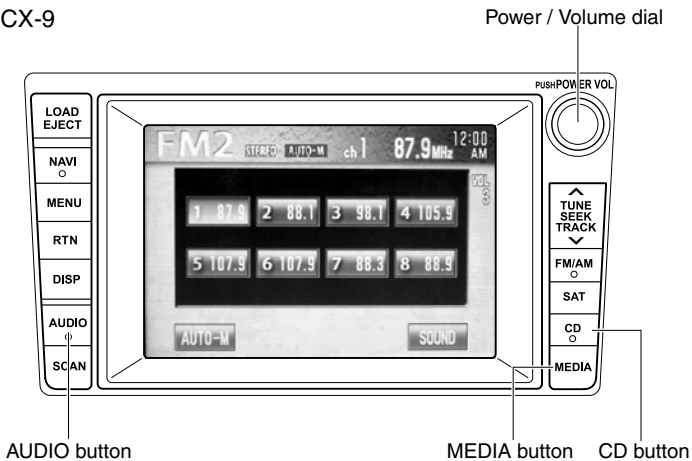

Mazda CX-7

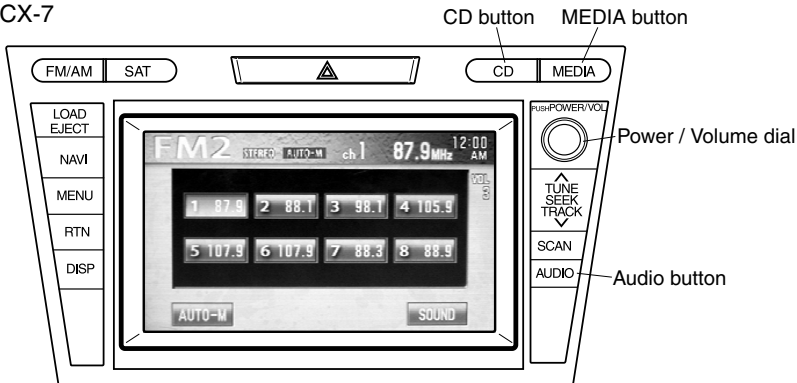

## n Power ON/OFF

- Turn the ignition switch to the ACC or ON position.
- Press the power/volume dial to turn the audio system on.
- Press the power/volume dial again to turn the audio system off.

### Note

To prevent the battery from being discharged, do not leave the audio system on for a long period of time when the engine is not running.

## n Volume adjustment

- To adjust the volume, turn the power/volume dial.
- Turn the power/volume dial to the right to increase volume, to the left to decrease it.

## n Audio sound adjustment

(Mazda CX-9)

1. Press the desired button corresponding to one of the following modes.

- Audio button (AUDIO): Audio mode
- CD button (CD): CD mode
- MEDIA button (MEDIA): Image and Sound playback is possible using a portable video player connected to an external input terminal.\*

\*The external input terminal is not equipped on your vehicle because it is not standard equipment.

2. Select the (SOUND) on-screen button to display the sound adjustment screen.

3. Select the **AMP** on-screen button to display the sound adjustment screen (AudioPilot™, Centerpoint®, Rear seat-optimized).

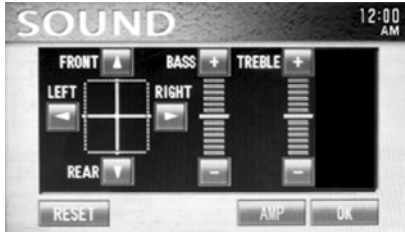

➔  
Select the  
**AMP** on-  
screen  
button.

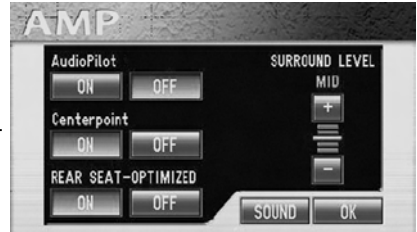

(Mazda CX-7)

1. Press the desired button corresponding to one of the following modes.

- Audio button (AUDIO): Audio mode
- CD button (CD): CD mode
- MEDIA button (MEDIA): Image and Sound playback is possible using a portable video player connected to an external input terminal.\*

\*The external input terminal is not equipped on your vehicle because it is not standard equipment.

2. Select the (SOUND) on-screen button to display the sound adjustment screen.



## n Sound quality adjustment

### TREB (treble sound)

Select the **+** on-screen button to increase treble, and **-** to decrease.



### BASS (low pitch sound)

Select the **+** on-screen button to increase bass, and **-** to decrease.





## n Volume balance adjustment



### Front/back volume balance

Select the FRONT on-screen button  to increase the volume at the front, and REAR  to increase the volume to the back.

### Left/right volume balance

Select the RIGHT on-screen button  to increase the volume to the right, and LEFT  to increase the volume to the left.



#### Note

- l Pressing an on-screen adjustment button for 0.5 seconds or more progressively changes the adjustment range towards +/–, up/down, or left/right.
- l While an adjustment button is selected in this manner, the level indicator will momentarily stop at the medium range position and a beep sound will be heard before proceeding.
- l Select the  on-screen button to reset bass, treble, and balance.
- l To return to the previous screen, select the  on-screen button.

## n AudioPilot™

AudioPilot automatically adjusts audio volume and sound quality in accordance with the level of noise entering the vehicle interior while driving. When AudioPilot is turned ON, the system automatically calculates the conditions for optimum hearing of sound which may be difficult to hear depending on exterior noise.

(Mazda CX-9)

Select the AUDIOPILOT on-screen  button when AudioPilot is on. Select the AUDIOPILOT on-screen  button when AudioPilot is off.

(Mazda CX-7)



Each time the  on-screen button is selected, the Audio Pilot turns on and off.

AudioPilot™ is a registered trademark of Bose Corporation.

## n Centerpoint®

Centerpoint offers you the experience of 5.1 channel surround sound in your vehicle even with your conventional 2 channel sound.

(Mazda CX-9)

Select the Centerpoint on-screen  button when Centerpoint is on. Select the Centerpoint on-screen  button when Centerpoint is off.

(Mazda CX-7)

When Centerpoint is on, the true surround sound effect of Centerpoint can be adjusted to any one of five level between minimum and maximum enhancement.

#### Note

- l Centerpoint does not work with AM/FM/SIRIUS/AUX.
- l Centerpoint operates only with a 2-channel stereo CD. Poor sound quality in the audio signal playback could result from playing highly compressed audio such as MP3 with Centerpoint operating.
- l If a CD or a DVD is inserted in the Rear Entertainment System main unit and selected as an audio source, and the CD or DVD audio is 5.1 DolbyDigital/DTS audio, Centerpoint cannot be selected. (Mazda CX-9 only)

Centerpoint® is a registered trademark of Bose Corporation.

### n Rear seat-optimized (With Rear Entertainment System) (Mazda CX-9 only)

The rear seat-optimized function allows passengers to optimize the audio output to the rear for a more pleasurable acoustic field.

Select the REAR SEAT-OPTIMIZED on-screen **ON** button to increase the surround effect to the rear seat. Select the REAR SEAT-OPTIMIZED on-screen **OFF** button to apply the surround effect to all seats.

#### Note

Rear seat-optimized is only effective if a CD or a DVD is inserted in the Rear Entertainment System main unit and selected as an audio source, and the CD or DVD audio is 5.1 DolbyDigital/DTS audio.

### n Surround

#### Centerpoint

When Centerpoint is on, the true surround sound effect of Centerpoint can be adjusted to any one of five level between minimum and maximum enhancement.

Indication	Enhance change
CENTERPT MIN	Minimum
CENTERPT LOW	Low
CENTERPT MID	Medium
CENTERPT HI	High
CENTERPT MAX	Maximum

#### Rear seat-optimized (Mazda CX-9 only)

When rear seat-optimized is on, the surround effect can be enjoyed at five separate levels.

Indication	Enhance change
Surround MIN	Minimum
Surround LOW	Low
Surround MID	Medium
Surround HI	High
Surround MAX	Maximum

# Operating the Radio

Mazda CX-9

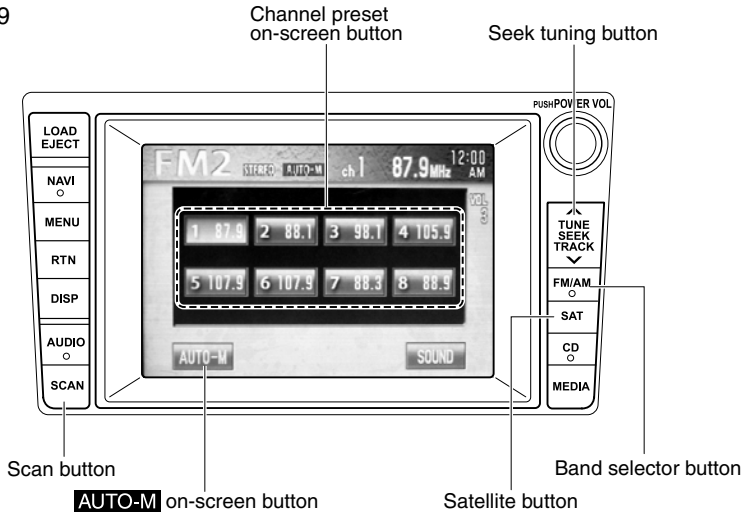

Mazda CX-7

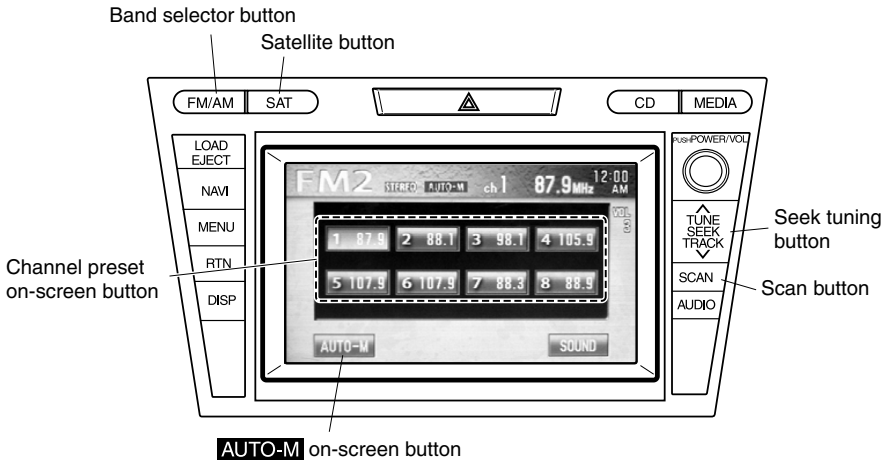

## n Radio ON

Press a band selector button (FM/AM) to turn the radio on.

## n Band selection

Successively pressing the band selector button (FM/AM) switches the bands as follows:  
FM1 → FM2 → AM.

The selected mode will be indicated. If FM stereo is being received, STEREO will be displayed.

## n **Tuning**

The radio has the following tuning methods: Manual, Seek, Scan, Preset channel, and Auto memory tuning. The easiest way to tune stations is to set them on preset channels.

### **Note**

- | If the FM broadcast signal becomes weak, reception automatically changes from STEREO to MONO for reduced noise, and the STEREO indicator will go out.
- | To clear the information, press the NAVI button.
- | If the power supply is interrupted (fuse blows or the battery is disconnected), the preset channels will be canceled.

## n **Manual tuning**

Pressing the seek tuning button will change the frequency higher or lower.

## n **Seek tuning**

Pressing and holding the seek tuning button (∧, ∨) will cause the tuner to seek a higher or lower frequency automatically.

### **Note**

If you continue to press and hold the button, the frequency will continue changing without stopping.

## n **Scan tuning**

Press the (SCAN) button to automatically sample strong stations.

Scanning stops at each station for about 5 seconds. To hold a station, press the (SCAN) button again during this interval.

## n **Preset channel tuning**

The 8 preset channels can be used to store 8 AM and 16 FM stations.

1. To set a channel first select AM, FM1, or FM2. Tune to the desired station.
2. Select any channel preset on-screen button for about 2 seconds until a beep sound is heard. The selected preset channel number and station frequency will be displayed. The station is now held in the memory.
3. Repeat this operation for the other stations and bands you want to store. To tune one in the memory, select AM, FM1, or FM2 and then press its channel preset button. The station frequency and the channel number will be displayed.

### **Note**

If the power supply is interrupted (fuse blows or the battery is disconnected), the preset channels will be canceled.

## n **Auto memory tuning**

This is especially useful when driving in an area where the local stations are not known. Additional AM/FM stations can be stored without disturbing the previously set channels.

Select and hold the **AUTO-M** on-screen button for about 2 seconds until a beep sound is heard; the system will automatically scan and temporarily store up to 8 stations with the strongest frequencies in each selected band in that area.

## n **Audio Sound Adjustment**

Refer to “Power/Volume/Sound Controls”.

## n **Satellite Radio (SAT)**

Vehicles equipped with the separately purchased SIRIUS digital satellite radio unit have the ability to receive up to 100 channels of digital quality programming coast to coast via satellite. For information on use, read the Satellite Radio Kit manual accompanying the SIRIUS digital satellite radio unit. A subscription to SIRIUS digital satellite radio service is required (available in the U.S. - Except Alaska and Hawaii) to enable this feature once the separately purchased SIRIUS digital satellite radio unit has been installed. For subscription information or digital satellite radio technical issues contact SIRIUS directly at:

-Web: [www.siriusradio.com](http://www.siriusradio.com)

-Phone (24 hrs/day, 7 days/week): 888-539-SIRI (7474)

-E-mail: [customercare@sirius-radio.com](mailto:customercare@sirius-radio.com)

-Mailing Address: Sirius Satellite Radio  
1221 Avenue Of The Americas  
New York, NY 10020  
Attention: Customer Care

Include your Sirius Radio ESN (Electronic Serial Number) when subscribing or requesting technical assistance. See the Satellite Radio Kit manual accompanying the SIRIUS unit for complete satellite radio activation procedures and information on how to display the ESN#.

# Operating the In-Dash CD Changer

## Mazda CX-9

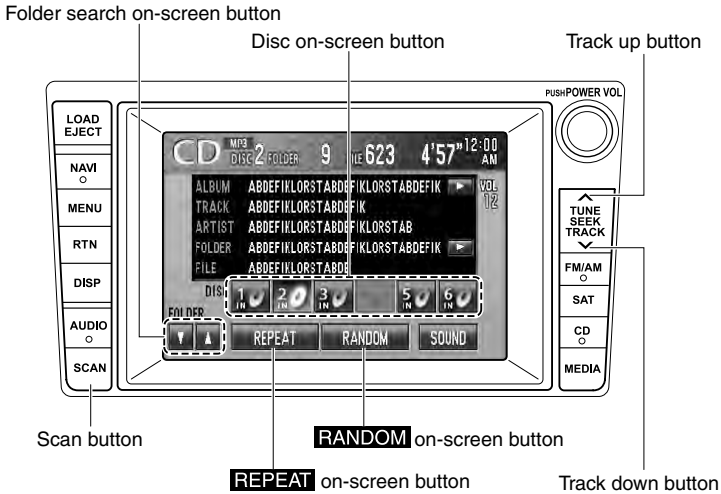

## Mazda CX-7

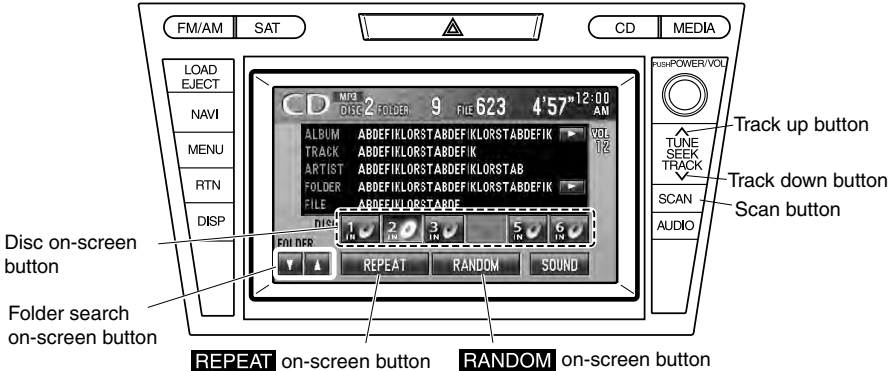

### n Inserting the CD

The display must be open (lowered) to insert the CD.

The CD must be label-side up when inserting. The auto-loading mechanism will set the CD and begin play. There will be a short lapse before play begins while the player reads the digital signals on the CD.

#### Note

"IN" is displayed on the tray number for a CD that is inserted.

### n During CD playback

The disc title, the track title, and the artist name will be displayed.

## n During MP3 CD playback

The album title, the track title, the folder name, the file number, and the artist name will be displayed.

### Note

The CD will begin playback automatically after insertion. A CD cannot be inserted while the display reads "WAIT".



## n Normal insertion

1. Press the (LOAD/EJECT) button.
2. Press the **LOAD** on-screen button lightly.  
The display opens and "WAIT" is displayed.
3. Lightly insert the CD after "IN" is displayed. The CD will be inserted and played automatically after the display is closed.

### Note

- | A CD cannot be inserted while "WAIT" is displayed. Wait until "IN" is displayed.
- | The CD loading operation cancels 15 seconds after "IN" is displayed or if the (LOAD/EJECT) button is pressed again.

## n Inserting CDs into desired tray number

1. Press the (LOAD/EJECT) button.
2. Press the desired tray number, then press the **LOAD** on-screen button lightly.  
The display opens and "WAIT" is displayed.

### Note

The CD loading operation cancels if no button is pressed for about 30 seconds after the desired tray number is pressed, or if the (LOAD/EJECT) button is pressed again.

3. Lightly insert the CD after "IN" is displayed. The CD will be inserted and played automatically after the display is closed

### Note

- | The CD loading operation cancels 15 seconds after the **LOAD** on-screen button is pressed or the (LOAD/EJECT) button is pressed again.
- | The CD cannot be inserted to the desired tray number if it is already occupied.

## n Multiple insertion

1. Press the (LOAD/EJECT) button.
2. Press the  on-screen button for 1.5 seconds or more.  
The display opens and "WAIT" is displayed.
3. Lightly insert the CD after "IN" is displayed.
4. When "IN" is displayed again, insert the next CD.  
Repeat this procedure for the number of CDs to be inserted (maximum of 6 including the CD in the tray).  
The CD will begin playback automatically after insertion and the display closes.

### Note

The CD loading operation cancels 15 seconds after "IN" is displayed, or the (LOAD/EJECT) button is pressed again.

## n Normal ejection

1. Press the (LOAD/EJECT) button.
2. Press the  on-screen button lightly.
3. The CD ejects after the display is opened and the desired tray number flashes.
4. The display closes automatically after the ejection is fully completed.

### Note

If the CD is not removed from the slot within 15 seconds, it will be re-inserted. When this happens, or if the (LOAD/EJECT) button is pressed again, the CD ejecting operation will be canceled.

## n Ejecting CDs from desired tray number

1. Press the (LOAD/EJECT) button.
2. Press the desired CD tray number, then press  on-screen button lightly.

### Note

The CD ejecting operation cancels if the  on-screen button is not pressed for about 30 seconds after the desired tray number is pressed, or if the (LOAD/EJECT) button is pressed again.

3. The CD will be ejected automatically after the display is opened and the desired tray number flashes.

### Note

- | If only one CD is inserted in the tray, the display opens and the CD is ejected without pressing  on-screen button.
- | If the CD is not removed from the slot within 15 seconds or if the (LOAD/EJECT) button is pressed, the CD ejecting operation will be canceled.

4. The display closes after the CD is ejected.



## n Multiple ejection

1. Press the (LOAD/EJECT) button.
2. Press the **EJECT** on-screen button for 1.5 seconds or more.  
The CD ejects after the display is opened and the desired tray number flashes.
3. Pull out the CD.
4. The next CD will be ejected automatically.  
This operation repeats until all the CDs are taken out.

### Note

If the CD is not removed from the slot within 15 seconds or if the (LOAD/EJECT) button is pressed, the CD ejecting operation will be canceled.

## n Playing

Press the (CD) button to start play when a CD is in the unit.

If there is no CD in the unit when the (CD) button is pressed, "NO DISC" will flash on and off.

The song information will be displayed during playback.

## Music CD



## MP3 CD





### Note

- | "-----" will be displayed for files without a file, track or other name input.
- | This unit can read English (including numerals), French, and Spanish one-byte characters.
- | The displayable number of characters on each title is a maximum of 64.

(Music CDs)

- | Although textual information (Track/artist information) recorded to each track appears in the display, textual information (Album/artist information) recorded for the entire CD does not appear in the display.

For details, refer to "CD-TEXT" (  page 62).

Select the  on-screen button if the whole title cannot be displayed at one time. The screen changes to display the rest of the characters.

### n **Fast-forward/Reverse**

Press the track up button () to advance through a track at high speed until a beep sound is heard.

Press the track down button () to reverse through a track at high speed until a beep sound is heard.

### n **Track search**

Press the track up button () once to skip forward to the beginning of the next track.

Press the track down button () once to skip back to the beginning of the current track.

Press the track down button () during track search to skip back to the beginning of the previous track.

### n **Disc search**

To change the disc, press any DISC on-screen button during playback.

### n **Folder search (during MP3 CD playback)**

To change to the previous folder, select the  on-screen button, or select the  on-screen button to advance to the next folder.

### n **Music scan**

This feature helps to find a program by playing about the first 10 seconds of each track.

Press the (SCAN) button during play to start scan play operation (the track number will flash).

Press the (SCAN) button once again to cancel scan play.

### Note

If the unit is left in scan, normal play will resume where scan was selected.

## **n Repeat play**

### **During music CD playback**

1. Select the **REPEAT** on-screen button during playback to play the current track repeatedly.
2. Select the button again to cancel the repeat play.

### **During MP3 CD playback**

#### **(Track repeat)**

1. Select the **REPEAT** on-screen button during playback to play the current track repeatedly.
2. To cancel the repeat play, select the button again after 3 seconds.

#### **(Folder repeat)**

1. Select the **REPEAT** on-screen button during playback, and then select the button again within 3 seconds to play the tracks in the current folder repeatedly.
2. Select the button again to cancel the repeat play.

## **Random play**

Tracks are randomly selected and played.

### **During music CD playback**

1. Select the **RANDOM** on-screen button during playback to play the tracks on the CD randomly.
2. Select the button again to cancel the random play.

### **During MP3 CD playback**

#### **(Folder random)**

1. Select the **RANDOM** on-screen button during playback to play the tracks in the folder randomly.
2. To cancel the random play, press the button again after 3 seconds.

#### **(CD random)**

1. Select the **RANDOM** on-screen button during playback, and then select the button again within 3 seconds to play the tracks on the CD randomly.
2. Select the button again to cancel the random play.

## **n Audio sound adjustment**

Refer to “Power/Volume/Sound Controls”.

## **n Operating tips for audio control switch**

### **VOICE switch**

Refer to “Voice Recognition” (  page 50).

## Adjusting the Volume

To increase the volume, pull up the volume switch.

To decrease the volume, press down the volume switch.

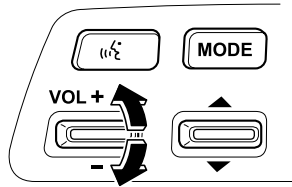

## Changing the Source

Press the mode switch (MODE) to change the audio source (FM1 radio > FM2 radio > AM radio > CD changer > SIRIUS > cyclical).

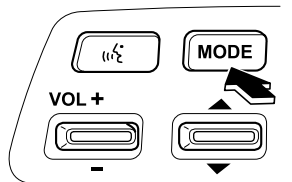

## Seek Switch

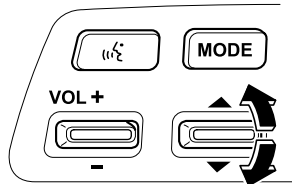

### When listening to the radio

Pull up or press down the seek switch, the radio switches to the next/previous stored station in the order that it was stored (1-6).

Pull up or press down the seek switch for about 2 seconds until a beep sound is heard to seek all usable stations at a higher or lower frequency whether programmed or not.

### When playing a CD

Pull up the seek switch to skip to the next track.

Press down the seek switch to repeat the current track.

## n Safety Certification

This CD player is made and tested to meet exacting safety standards. It meets FCC requirements and complies with safety performance standards of the U.S. Department of Health and Human Services.



- | This CD player should not be adjusted or repaired by anyone except qualified service personnel. If servicing is required, contact an Authorized Mazda Dealer.
- | Use of controls or adjustments or performance of procedures other than those specified herein may result in hazardous laser exposure. Never operate the CD player with the top case of the unit removed.
- | Changes or modifications not expressly approved by the party responsible for compliance could void the user's authority to operate this equipment.

### Note

For CD player section:

This device complies with part 15 of the FCC Rules. Operation is subject to the following two conditions: (1) This device may not cause harmful interference, and (2) this device must accept any interference received, including interference that may cause undesired operation.

### Note

This equipment has been tested and found to comply with the limits for a Class B digital device, pursuant to part 15 of the FCC Rules. These limits are designed to provide reasonable protection against harmful interference in a residential installation. This equipment generates, uses, and can radiate radio frequency energy and, if not installed and used in accordance with the instructions, may cause harmful interference to radio communications. However, there is no guarantee that interference will not occur in a particular installation.

# MEMO



Audio Operation

# Contents

---

## Rear View Monitor

- n Rear View Monitor
  - | Rear View Monitor Cautions..... 86
  - | Rear View Parking Camera Location ..... 86
  - | Switching to the Rear View Monitor Display..... 87
  - | Displayable Range on the Screen ..... 87
  - | Rear View Monitor Operation ..... 88
  - | Variance Between Actual Road Conditions and Displayed Image 89

---



# Rear View Monitor

## Rear View Monitor Cautions

The rear view monitor is a visual assist system when reversing the vehicle that provides images from the rear of the vehicle.



The rear view monitor is only a visual assist device when reversing the vehicle. The images on the screen may be different from the actual conditions. Always drive carefully confirming the safety of the rear and the surrounding conditions by looking directly with your eyes. Reversing the vehicle by only looking at the screen may cause an accident or a collision with an object.



- | When the display is cold, images may course across the monitor or the screen and may be dimmer than usual, which could cause difficulty in confirming the surrounding conditions of the vehicle. Always drive carefully confirming the safety of the rear and the surrounding conditions by looking directly with your eyes.
- | Do not apply excessive force to the camera. The camera position and angle may deviate.
- | Do not disassemble, modify, or remove it as it may no longer be waterproof.
- | The camera cover is made of plastic. Do not apply degreasing agents, organic solvents, wax, or glass coating agents to the camera cover. If any are spilled on the cover, wipe off with a soft cloth immediately.
- | Do not rub the cover excessively, or polish it using an abrasive compound or a hard brush. The cover may be damaged affecting the image.

### Note

- | If water, snow, or mud is stuck on the camera lens, wipe it off using a soft cloth. If it cannot be wiped off, use a mild detergent.
- | If the camera temperature changes rapidly, such as by pouring hot water on it under cold temperature conditions, the rear view monitor may not operate correctly.

## Rear View Parking Camera Location

Mazda CX-9  
Rear View Parking Camera

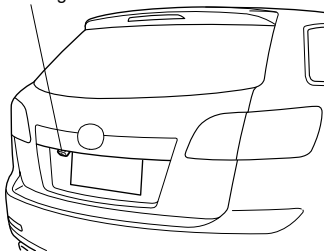

Mazda CX-7  
Rear View Parking Camera

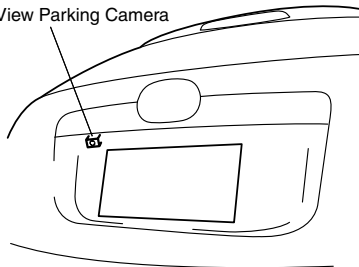



# Switching to the Rear View Monitor Display

Shift the shift lever to R with the ignition switch in the ON position to switch the display to the rear view monitor display.

## Note

When the shift lever is shifted from R to another shift lever position, the screen returns to the previous display.

# Displayable Range on the Screen

The images on the screen may be different from the actual conditions.

(Screen display)

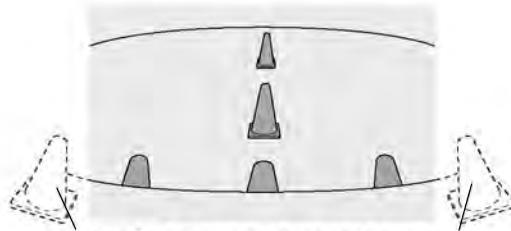

Both bumper ends are not displayed.

Both bumper ends are not displayed.

(Actual view)

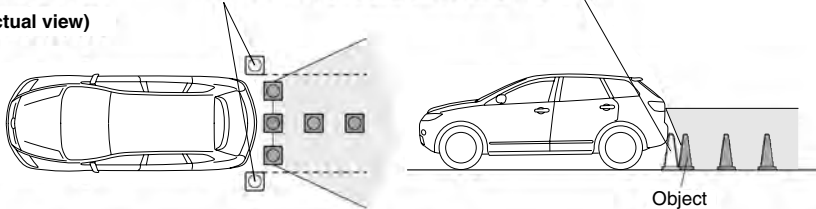

The figure is an example showing Mazda CX-9.

## Note

- | The displayable range varies depending on the vehicle and road conditions.
- | The displayable range is limited. Objects under the bumper or around the bumper ends cannot be displayed.
- | The distance appearing in the displayed image is different from the actual distance because the rear view parking camera is equipped with a specific lens.
- | Some optionally installed vehicle accessories may be picked up by the camera. Do not install any optional parts that can interfere with the camera view, such as illuminating parts or parts made of reflective material.
- | It may be difficult to see the display under the following conditions, however, it does not indicate a malfunction.
  - In darkened areas.
  - When the temperature around the lens is high/low.
  - When the camera is wet such as on a rainy day or during periods of high humidity.
  - When foreign material such as mud is stuck around the camera.
  - When the camera lens reflects sunlight or headlight beams.
- | If the camera picks up a high-intensity light such as sunlight reflected off the vehicle body, a bright belt (light line) may appear on the display. (Smear phenomenon)

# Rear View Monitor Operation

The operation of the rear view monitor when reversing the vehicle varies depending on the traffic, road, and vehicle conditions. The amount of steering and the timing also varies depending on conditions, so confirm the surrounding conditions directly with your eyes and steer the vehicle in accordance with the conditions.

Be well aware of the above cautions prior to using the rear view monitor.

## Note

Images displayed on the navigation display from the rear view parking camera are reversed images (mirror images).

- (1) Shift the shift lever to R to switch the display to the rear view monitor display.
- (2) Confirming the surrounding conditions, reverse the vehicle.

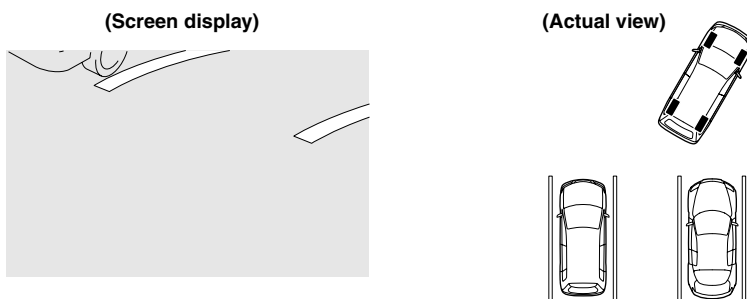

The figure is an example showing Mazda CX-9.

- (3) When the shift lever is shifted from R to another shift lever position, the screen returns to the previous display.

# Variance Between Actual Road Conditions and Displayed Image

Some variance occurs between the actual road and the displayed road. Such variance in distance perspective could lead to an accident. Note the following conditions that may cause a variance in distance perspective.

## 1 When the vehicle is tilted due to the weight of passengers and load

When the vehicle rear is lowered, the object displayed on the screen appears farther than the actual distance.

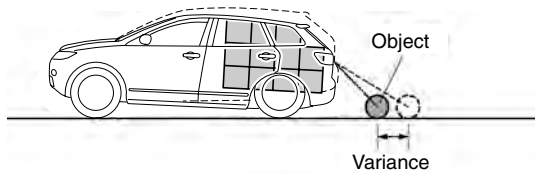

The figure is an example showing Mazda CX-9.

## 2 When there is a steep grade behind the vehicle

When there is a steep upgrade (downgrade) behind the vehicle, the object displayed on the screen appears farther (downgrade: closer) than the actual distance.

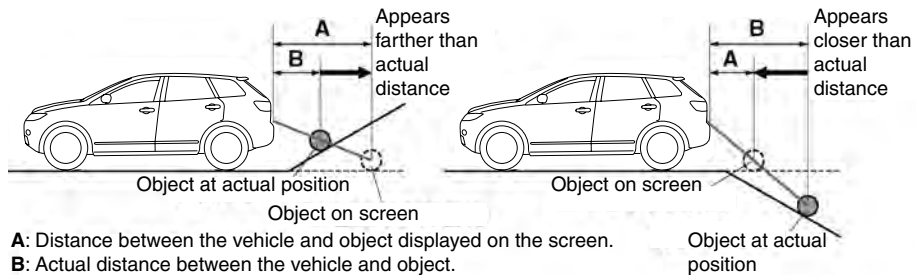

The figure is an example showing Mazda CX-9.

# MEMO



Rear View Monitor

# Contents

---

## Bluetooth Hands-Free

- n Bluetooth Hands-Free (Mazda CX-9 only)
- l Screen display of Bluetooth Hands-Free information ..... 92

---



# Bluetooth Hands-Free

## Screen display of Bluetooth Hands-Free information

If the Bluetooth Hands-Free is operated, information such as radio wave reception conditions of the Bluetooth Hands-Free are displayed on the screen. For details, refer to the "Bluetooth Hands-Free" in the owner's manual.

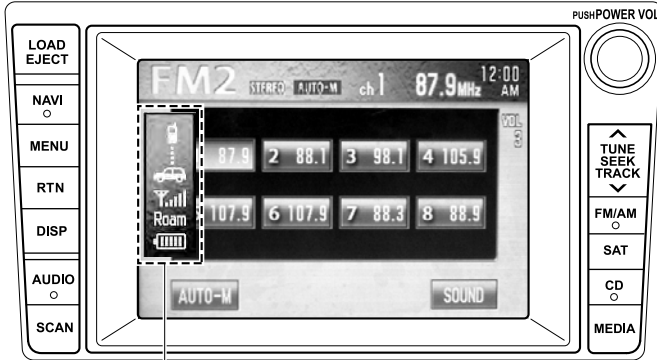

Bluetooth Hands-Free information